

TRADE CATALOGUE

2022-2023



For over 75 years quality and technology on the road

Travelling on board a motorhome is the best way to get to know the world. In absolute freedom, you can decide when to leave and where to stop. With friends or family, by the sea or at the foot of a mountain, you can imagine the trip you want, if your vehicle has Fiamma products.

The quality of each item, tested in the laboratory and then on the road, along with professional assistance always available will make every trip an unforgettable moment of dolce vita.

Founded in Italy in 1945, Fiamma is an international leader in the development of technical accessories to convert your vehicle into the ideal vehicle for every adventure. Its products offer you technology and quality without boundaries.



CONTENTS



ACCESSORIES

Chocks, Levels & Stabilisers	2
Bike Racks & Ladders	4
Portable Steps	7
Fire, Safety & First Aid	8
Kitchen & Laundry	9
Camping	14
Books & Maps	19
Tie Downs	20
Cleaners	22



TV & ANTENNAS

Televisions	23
Television Mounting Brackets	26
Antennas	27
Antenna Accessories & Spares	28
Speakers	31
Audio Accessories	31



AWNINGS

Awnings	33
Annexes	38
Awning Accessories	40
Awning Spare Parts	44
Privacy Screens	52
Flooring	52
Covers	53



APPLIANCES

Air Conditioning	56
Fridges	57
Ice Makers	71
Fridge Accessories	73
Fridge Spare Parts	74
Microwaves	76
Rangehoods & Stoves	77
Washing Machines	78



ELECTRICAL

Auto Lights	81
Batteries	89
Solar	91
Connectors, Sockets & Switches	93
Globes & Fuses	99
Interior & Exterior Lighting	102
Power 12V	106
Power 240V	108
Generators	110
Wiring	111
Chargers & Inverters	112



CHASSIS

Axles	113
Brakes	115
Hubs, Drums, Discs	116
Mudguards & Wheel Equipment	117
Jockey Wheels	118
Jockey Wheels Spare Parts	121
Corner Steadies	121
Couplings	123
Springs	126
Vehicle Steps	128
Caravan Movers	129



TOWING

Tow Balls, Covers Locks	130
Towing Mirrors	133
Towing Aids, Weight Distribution Hitch	135
Brake Controllers & System	139



HARDWARE & FURNITURE

Mattresses	142
Table Legs	143
Hinges	147
Cupboard Catches	148

Handles	150
Cupboard Stays	150
Gas Struts	151
Storage	151
One Key System	152
Internal Fixings	153
External Fixings	154
Curtains	156
Room Dividers	157
Roof	158



HATCHES & VENTS

Camec Roof Hatches	160
Camec Roof Hatches Spare Parts	161
Fiamma Roof Hatches	162
Fiamma Roof Hatches Spare Parts	164
Roof Hatches	165
Roof Hatches Spare Parts	166
Vents & Cows	168
Vents & Cows Spare Parts	170



SANITATION

Consumables	173
Portable Toilets	175
Fixed Toilets	176
Fixed Toilets Fittings	178
Holding Tanks & Accessories	180



PLUMBING

Hot Water Units	181
Tanks, Containers, Accessories	183
Hoses & Fillers	189
Plumbing Fittings	194
Pumps	200
Bathroom Modules	206
Sinks & Basins	207
Tapware	209
Filtration	215
Gas Compliance & Safety	216
Gas Copper Pipe & Fasteners	217
Gas Fittings & Adaptors	217
Gas Cylinders & Products	221
Gas Hoses	222
Gas Regulators	223



WINDOWS

Odyssey Windows	225
Odyssey Plus Windows	228
Odyssey Premium Windows	231
Jupiter Windows	233
Sash Frames	236
Odyssey Fly Screens	238
Slimline Slider & Wind Out Window Spare Parts	239
Viento Blinds	243



DOORS

Odyssey 4SC Doors	245
Odyssey 2RC Doors	247
Odyssey 4RC Doors	248
Odyssey Premium 2RC & 4RC Doors	249
Camec Vista 2RC Doors	252
Camec Aero Doors	253
Miscellaneous Main Doors	255
Camec Door Blinds	256
Spare Parts	257
Keyless Entry	258
Picnic Table	259
Camec 2RC, 4SC & 4RC Access Doors	260
Camec Boot Storage Doors	261
One Key System	262



BUILDING MATERIALS

Aluminium Cladding & Sheeting	263
Building Accessories	265
Plastic Mouldings	265



ACCESSORIES

- Chocks, Levels & Stabilisers 2
- Bike Racks & Ladders 4
- Portable Steps 7
- Fire, Safety & First Aid 8
- Kitchen & Laundry 9
- Books & Maps. 19
- Tie Downs 20
- Cleaners 22

CHOCKS, LEVELS & STABILISERS



CAMEC WHEEL LEVEL & CHOCK

040652

Wheel chock locks into ridges of the level ramp & secures the wheel safely in place.

FEATURES

- Level ramp has a solid base which means that it will not sink into soft ground
- Kit includes level, chock & anti-slip plate

SPECIFICATIONS

- Level ramp dimensions: 520mm(l) x 200mm(w) x 125mm(h)
- Chock dimension: 150mm(l) x 120mm(w) x 100mm(h)
- Colour: teal



CAMEC WHEEL CHOCK

040653

Can be used with levels to secure wheels during long stopovers or as a stand alone wheel chock.

FEATURES

- Manufactured from tough polypropylene plastic for superior strength

SPECIFICATIONS

- Dimension: 150mm(l) x 120mm(w) x 100mm(h)
- Colour: teal



CAMEC TYRE SAVER

040654

FEATURES

- Aids to prevent flat spots
- Can be used with most makes of wheel clamps
- Ideal for use as a “stop” by bolting down to a garage floor
- Suitable for use with caravans, trailers, prestige cars or any vehicle that isn’t moved for long periods

SPECIFICATIONS

- Pack of 2
- Colour: black



DUAL AXLE HEAVY DUTY LEVELLING RAMPS

050017

FEATURES

- Includes carry bag
- 2 chocks
- 2 ramps

SPECIFICATIONS

- 5 ton load rating
- 430mm x 195mm x 90mm dual axle wheel
- Short enough to fit between dual axle RVs



FIAMMA LEVEL UP

041408

Extremely strong levelling system with double central support that provides a maximum capacity of 5,000kg. Just drive the van straight on.

FEATURES

- UV resistant
- Lightweight
- Easy to clean
- Ridged surface
- 3 levels

SPECIFICATIONS

- Dimensions: 570mm(l) x 130mm(h) x 200mm(w)
- Weight: 1.5kg
- Maximum load weight: 5,000kg
- Pack of 2
- Colour: grey



FIAMMA LEVEL UP CHOCK

041406

The chock is to be used with Level Up, Level Pro & Level System Magnum to secure the wheels during long stopovers. Includes steel hooks to clip them together.

SPECIFICATIONS

- Pack of 2
- Made of UV resistant polyethylene
- Colour: grey

CHOCKS, LEVELS & STABILISERS

FIAMMA MAGNUM JACK WEDGE
000362

Practical self-locking overlapping system that can raise height. Ideal for motorhomes.

FEATURES

- Made in Italy
- You can stack 2 of these on one side to get greater height
- Non-skid finish

SPECIFICATIONS

- Dimensions: 500mm(l) x 200mm(w) x 90mm(h)
- Maximum Axle weight: 8,000kg
- Weight: 2 x 1.3kg
- Pack of 2

FIAMMA SUPPORT PLATES - LEGS
006455
006455
FEATURES

- Ideal for soft ground
- Helps support the vehicle's weight
- Permanently secured even when travelling
- To be fastened to the RV's stabiliser legs

SPECIFICATIONS

- Dimensions: 180mm(l) x 130mm(h) x 45mm(d)
- Pack of 4
- Colour: black

FIAMMA LEVEL BAG
036711

Made of washable polyester, it has a comfortable carry handle making transporting your levels easy.

FEATURES

- Washable polyester
- Carry handle
- Suits Fiamma Level-Ups, Magnum & Level Pro

SPECIFICATIONS

- Dimensions: 185mm(h) x 245mm(w) x 650mm(l)

FIAMMA LEVEL PRO STANDARD
041407

A simple way to level caravans. Ridged non-skid surface, lightweight & easy to store.

FEATURES

- UV resistant
- Ideal for vehicles & caravans with small wheels

SPECIFICATIONS

- Dimensions: 430mm(l) x 170mm(w) x 90mm(h)
- Maximum load weight: 5,000kg
- Pack of 2
- Colour: grey
- Weight: 0.8kg each

LEG SUPPORT PLATES WITH HANDLE
042669
042669
SPECIFICATIONS

- Set of 4 loose
- No fitting required
- Gives stabiliser legs a wider surface area to resist sinking

CAMEC ALUMINIUM STABILISERS
044487
044487

Height adjustable stabilisers - suits all RV vehicles, boat trailers, horse floats & tradesman's trailers.

FEATURES

- Made from high quality aluminium
- Simple operation

SPECIFICATIONS

- Minimum Height: 295mm
- Maximum Height: 430mm
- Pack of 4

STAB PAD SUPPORT STABILISER PADS
043177
043177

Stab Pads are Australian made jack pads. They are the largest of their type in Australia, & they provide maximum support. They can be put to multiple uses, including: as a jockey wheel support, jack support base, high lift jack support & many more.

FEATURES

- Ideal for soft ground
- Helps support the vehicle's weight

SPECIFICATIONS

- Pack of 5

CAMEC FRIDGE BULLS EYE LEVEL
042670
042670

The compact Fridge Bulls Eye Level can be used on any flat surface.

SPECIFICATIONS

- Dimensions: 43mm(diam.) x 10mm(h)

CAMEC PLASTIC LEVEL 2 WAY
042672
042672

Ideal for leveling your A-frame, this 2-way level has both left to right & front to back indicators.

SPECIFICATIONS

- Dimensions: 58mm(l) x 43mm(w)

CAMEC STICK ON LEVEL
042673
042673

Stick-on levels with self adhesive backing.

SPECIFICATIONS

- Dimensions: 38mm(l) x 25mm(h) x 5mm(d)
- Pack of 2

BIKE RACKS & LADDERS



FIAMMA BIKE CARRIER - CARAVAN

001042

An inexpensive & compact option that fits most caravans with an A frame. Pivots forward allowing access to storage compartment.

FEATURES

- Suits all caravans with an A frame (subject to space)
- Carries 2 bikes
- Compact
- No drilling required

SPECIFICATIONS

- Maximum weight load: 35kg



FIAMMA CARRY BIKE 200 - REAR DOOR

042372

They are installed on the right door leaving the left door free for the possible installation of a Deluxe ladder to access the roof of the vehicle.

FEATURES

- For 2 bikes
- Installation with Fixing Bar for Sprinter/Crafter versions
- The 200 D version has adjustable wheelbase from 90 to 118 cm



FIAMMA PRO E CARRY BIKE

050222

To transport two E-Bikes in complete safety.

Pro structurally sturdy model, equipped with fixed rail support base designed specifically for this type of bike, Bike-Block Pro S and Rail Premium.

The rail support base is not interchangeable with the standard Pro series version.



FIAMMA CARRY BIKE PRO - REAR WALL MOUNT

044417

The Fiamma Pro Series is setup for 2 bikes as standard, but can carry up to 4 bikes with the addition of optional rails & bike-blocks. Telescopic mounting bracket can be adjusted between 80 & 150cm providing great strength & stability for a wide range of different installation requirements. The Pro Series is delivered with Bike-Block Pro 1 & 3, Block 2 & 4 can be purchased for additional bikes.

FEATURES

- 2 bike capacity as delivered
- 4 bike capacity with optional rails & arms
- Designed for motorhomes without rear window
- 1 year warranty

SPECIFICATIONS

- 60kg capacity
- Black Aesthetics
- Weight: 10.66kg
- Dimensions: 1300mm(l) x 580mm(h) x 160mm(d)



FIAMMA CARRY BIKE DUCATO DJ

051500

To transport 2 bikes. The structure, thanks to the adoption of a single 35mm Ø aluminium tube, is light and modern, maintaining the solidity that has always distinguished this model.

The structure guarantees a quick and safe installation, also thanks to the new system of attachment of the main structure to the Fixing Bars.

This version allows the mounting of the rail support base in three positions, standard, intermediate and lowered to facilitate the loading of the bikes.

In the intermediate and lowered positions it is necessary to use the license plate holder bar with lighting group License Plate Carrier.

Two versions available: anodised aluminium and Deep Black version (in black aluminium).

Suitable for: Fiat Ducato III-IV series / Citroen Jumper II-III series / Peugeot Boxer II-III series (≥2006 - H2/H3).



FIAMMA CARRY BIKE PRO "COMPACT"

044418

The Fiamma Pro Series is setup for 2 bikes as standard, but can carry up to 4 bikes with the addition of optional rails & bike-blocks. The Pro C is a compact design which can be installed under a window. The telescopic frame can be adjusted in height from 40 to 50cm. The Pro Series is delivered with Bike-Block Pro 1 & 3, Block 2 & 4 can be purchased for additional bikes.

FEATURES

- 2 bike capacity as delivered
- 4 bike capacity with optional rails & arms
- Designed for motorhomes with rear window
- 1 year warranty

SPECIFICATIONS

- 60kg capacity
- Black Aesthetics
- Weight: 10.10kg
- Dimensions: 1300mm(l) x 580mm(h) x 160mm(d)



FIAMMA DELUXE REAR DOOR LADDER

051499

Supplied with Fixing Bars for easy and quick installation on the rear door.

It can be combined with Carry-Bike 200 DJ.

It can be installed on the following vehicles: Fiat Ducato, Citroën Jumper and Peugeot Boxer after 2006 and Ford Transit with double rear doors after 2006 before 2011.

SPECIFICATIONS

- Colour: Deep Black



FIAMMA CARRY BIKE DUCATO

051666

Characterised by the solid stainless steel supporting structure, they allow to fit two E-Bikes or 3 standard bikes/mountain bikes. The sturdy stainless steel frame is installed using the attachment points present as standard on the vehicle.

Allows the mounting of the rail support base in three positions, standard, intermediate and one lowered to facilitate the loading of the bikes. In the intermediate and lowered positions it is necessary to use the licence plate holder bar with lighting group Licence Plate Carrier.

Allows the rear door to be opened, even with bikes mounted

Available in two versions, anodised aluminium and black aluminium Deep Black, both versions have a stainless steel frame.

Not suitable for vehicles with 270° hinge system. Also suitable for vehicles with protruding windows.

Suitable for: Fiat Ducato III-IV serie / Citroen Jumper II-III serie / Peugeot Boxer II-III serie (≥2006 - H2/H3)



FIAMMA BIKE COVER

050002

Carry-Bike covers, made in polyester reinforced resin, light, water-proof material.

Enlarged dimensions to better cater for newer style bikes.

Fits 2 bikes.



FIAMMA BIKE BRACKET KIT LOWER

035312

Lower fitting kit for Carry Bike Pro.

FIAMMA BIKE BRACKET KIT UPPER

035318

Fiamma upper bike bracket kit.



FIAMMA CARRY BIKE MTG BRACKET

039508

Top fit bracket VW T5 carry bike rack.



FIAMMA CARRY BIKE BLOCK 2

044767

Colour Black.

This genuine Fiamma replacement is used to hold the second bike in place, it will suit any Fiamma Pro series rack.



FIAMMA CARRY BIKE BLOCK 3

035370

The quick front clamp with its large non-scratch base fits round & oval bike tubes with diameters from 25mm to 100mm. Suitable for all Carry-Bike models. Holds the 3rd bike in place.

SPECIFICATIONS:

- Colour: Red



FIAMMA CARRY BIKE BLOCK 4

044768

Holds the 4th bike in place.

SPECIFICATIONS:

- Colour: Black



FIAMMA FIX ORGANISER

050735

Used to hold Fiamma Organisers.



FIAMMA CARRY BIKE BLOCK 1 CARAVAN

035382

Fiamma Bike Block Pro 1 is an exclusive fixing system that keeps your bikes in place whilst attached on your bike rack.

FEATURES

- Strong & safe the clamp has a front clasp with a large, non-scratch base
- Models in this range fit around oval bike tubes with diameters ranging from 25mm to 80mm
- Compatible with all carry bike models & feature 360° ends for fast, safe fitting
- Bike Block Pro 1 extends to: min 12.5cm – max 15.5cm
- Suitable for use with all Fiamma Carry Bike racks
- Features a larger padded bicycle support base



FIAMMA EXTENSION RAIL S-PRO CARRIER

035333

Extension rail can carry extra bike & can slide horizontally for easy positioning.

SPECIFICATIONS

- Brackets included
- Dimensions: 1280mm(l)
- Weight: 1.15kg



INTERNAL FIAMMA DELUXE 4 RUNG BUNK LADDER

001047

Aluminium ladder for interior use. Ideal for bunks.

FEATURES

- Can be dismantled into 2 pieces
- Handy hooks hold ladder in place against bunks

SPECIFICATIONS

- Dimensions: 350mm(w) x 1540mm(l)
- Inside Width: 280mm



INTERNAL FIAMMA DELUXE 5 RUNG BUNK LADDER

001048

Aluminium ladder with 5 steps at 15° inclination, making climbing more comfortable. Great for over-cab or bunk beds. Height of ladder when located into brackets ready for use is 1630mm.

FEATURES

- High quality, in anodised aluminium
- Can be folded up whilst travelling
- Non skid steps

SPECIFICATIONS

- Dimensions: 350mm(w) x 1785mm(l)
- Inside Width: 280mm

PORTABLE STEPS



2 ALUMINIUM FOLDING STEP

050016

2 step folding aluminium frame, folds flat for storage in the caravan & RV.

FEATURES

- Lightweight & compact

SPECIFICATIONS

- Maximum load weight: 150kg
- dimensions (at base): 515mm(w) x 380mm(h) x 530mm(d)



HEIGHT ADJUSTABLE METAL STEP

050015

SPECIFICATIONS

- Maximum load weight: 300kg
- Dimensions (at highest): 480mm(l) x 370mm(w) x 220mm(h)



CAMEC FOLDING ALUMINIUM STEP

041599

Made from sturdy aluminium, this step is extra wide for stability and safety. It has a non-skid tread to ensure no nasty slips. The legs fold up making it extra convenient for travelling. Rubber feet ensures the step doesn't move while being used.

SPECIFICATIONS

- Dimensions: 450mm(l) x 215mm(h) x 365mm(d)



CAMEC PORTABLE PLASTIC STEP

041598

Lightweight & strong. For the camper van, caravan, or around the home.

SPECIFICATIONS

- Dimensions: 480mm(l) x 230mm(h) x 350mm(w)



FIAMMA STEP

000743

Step in & out of your RV safely with this step. It has a non skid surface & is made from UV resistant heavy duty polyethylene.

FEATURES

- Lightweight & compact

SPECIFICATIONS

- Maximum load weight: 150kg
- Dimensions (at base): 500mm(l) x 230mm(h) x 355mm(d)
- Plastic
- Colour: platinum



FIAMMA STEP MAGNUM

000745

Large reinforced plastic caravan step. Made from UV resistant heavy duty polyethylene for great stability & strength.

SPECIFICATIONS

- Maximum load weight: 200kg
- dimensions (at base): 580mm(l) x 400mm(w) x 240mm(h)
- Plastic
- Colour: platinum

FIRE, SAFETY & FIRST AID



FIRST AID KIT TRAVEL

000131

Soft pack first aid kit with simple design & practical internal layout have proved to be a winning combination. This is perfect compact kit is ideal for the glove box, cupboard or suitcase when travelling.

FEATURES

- Represents great value
- Embroidered, hard-wearing, zippered, canvas case
- Compact size
- 1 year warranty



FIRE EXTINGUISHER

000348

Dry chemical ABE 1kg fire extinguisher. Robust brass head & steel construction, heavy duty bracket included (metal).

SPECIFICATIONS

- Weight: 2.4kg
- Suitable for Class B & E fires
- Fire rating: 1A:20B:E
- Suitable for Class A: Ordinary - wood/paper/cloth, B: Flammable liquids, E: Electrical
- Also available in .75m capacity (051319)



FIRE EXTINGUISHER METAL HOLDER

000350

Additional bracket for 000348.



FIRE EXTINGUISHER PLASTIC BOX

000351

Colour: beige

Box flush mounts into a panel allowing extinguisher to be out of the way, yet still accessible.



FIRE BLANKET

000354

Fireproof fibreglass blanket suitable for Class F (cooking oils & fat) fires. Stows neatly in quick release sheath which measures 175mm x 295mm.

FEATURES

- Blanket Dimensions: 1000mm X 1000mm



CARBON MONOXIDE ALARM

050089

Protect your family & safeguard your RV by adding a Quell Carbon Monoxide alarm - they're cost effective & easy to install!

FEATURES

- Peak level memory displays the highest CO concentrate measured since the last reset
- Self activation alarm automatically activates when attached to the mounting bracket
- Test/Reset button tests the alarm circuitry & horn. Resets memory after the alarm has sounded
- LED indicators Flashing green LED every 30 seconds indicates the unit is operating properly. Pulsing red LED with alarm indicates a dangerous level of carbon monoxide has been detected. Amber LED indicates the unit is in fault mode
- Deactivation switch disables the alarm to allow for safe battery disposal once the unit has reached the end of its 10-year life
- 10 year limited warranty Provides peace-of-mind with a decade of carbon monoxide detection
- 3 x AA batteries included



SMOKE ALARM

000340

9V battery ionisation smoke alarm. The ionisation sensor provides an early warning to fast burning fires.

FEATURES

- Ionisation sensor detects fast flaming fires
- Very loud alarm
- Low battery warning
- Compliant with AS3786 - 1993
- 9V battery included
- Battery removed indicator - does not allow front cover to close without battery
- Easy installation, mounting screws included
- Alarm test button allows regular testing to ensure alarm is operating
- Hush button to silence nuisance alarms



QUELL CARAVAN SMOKE ALARM – LITHIUM BATTERY

051665

Changes to the Environmental Planning and Assessment Regulation have introduced the requirement for smoke alarms be installed in areas where people sleep for all existing and new caravans, campervans, motorhomes, park vans and associated structures.

The Quell QC1500 Photoelectric smoke alarm has been designed to face the rigors you would typically expect in mobile dwellings such as heightened vibration, extremes in temperature and the potential of nuisance alarms from dust, bugs and cooking.

Sealed, non-removable lithium-ion battery. No battery installation or replacement necessary for the life of the alarm

KITCHEN & LAUNDRY



FIAMMA OMNISTOP PLATE RETAINER

000107

A simple way to keep plates & items in place as your travel. Easy to lock & unlock, the securing bar is made from anodized aluminium & is 25cm high. The support handle is a sturdy plastic & is 20cm long.

FEATURES

- Easy to fix & release
- 200mm sturdy plastic support handle



CUTLERY TRAY COMPACT WHITE

000115

Compact cutlery tray with 5 divisions.

SPECIFICATIONS

- Dimensions: 330mm(l) x 252mm(w) x 40mm(h)
- White

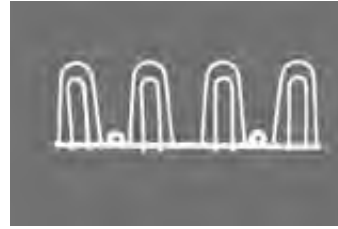

GLASS HOLDER RACK

041607

Vinyl coated wire rack, holds 4 glasses. 260mm wide.

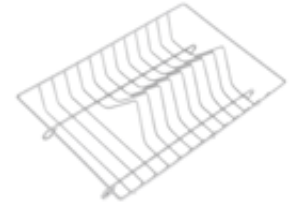

MINI DISH DRIER

041601

Perfect for small sinks.

SPECIFICATIONS

- Dimensions: 308mm(l) x 210mm(w) x 50mm(h)



PLASTIC DISH DRAINER WITH LID

041602

Fits most RV sinks & is sized just right for limited counter space. Sloped drainer tray keeps counters dry. Made from heavy duty plastic.

SPECIFICATIONS

- Dimensions: 360mm(l) x 315(w) x 120mm(h)



CORNER PLATE STACKER

041604

SPECIFICATIONS

- Dimensions: 240mm(l) x 240mm(w) x 190mm(h)

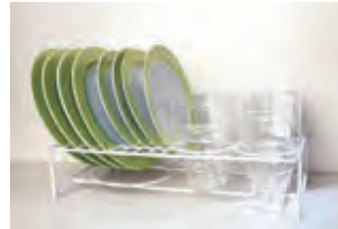

CROCKERY RACK 4 CUP

041603

SPECIFICATIONS

- Holds 4 cups plus 4 plates + 4 side plates
- Dimensions: 395mm(l) x 230mm(w) x 130mm(h)



CUP & PLATE HOLDER

041606

Holds 6 cups & 3 stacks of plates.

SPECIFICATIONS

- Dimensions: 335mm(w) x 220mm(d) x 270mm(h)



MIRACLE GRIP

000147 BEIGE

000148 BLUE

FEATURES

- Cushions & protects
- Long lasting, hand washable
- Lightweight
- Easily cuts to any size
- 900mm wide
- Non slip



PLACE-IT MAT

000171 HUNTER GREEN

000172 TEAL GREEN

000174 BLACK

FEATURES

- Cushions & protects
- Long lasting, hand washable
- Lightweight
- Non slip



FIAMMA STOWAGE POCKET

016879

FEATURES

- Easily installed on doors or walls

SPECIFICATIONS

- Dimensions: 260mm(l) x 165mm(h) x 80mm(d)
- White



CAMEC CLOTHES DRYER DELUXE

042668

Lightweight & slimline, this clothesline hooks over a door or similar for quick & easy airing.

SPECIFICATIONS

- Dimensions: 590mm(l) x 50mm(h) when flat



CAMEC EXPANDA CLOTHESLINE

043133

Expanding clothes line, fixes to your caravan or RV.

SPECIFICATIONS

- Dimensions: 750mm(w) x 650mm(l) expanded
- Easy removal for travel



COLLAPSIBLE LAUNDRY BASKET

042674

Lightweight collapsible laundry basket.

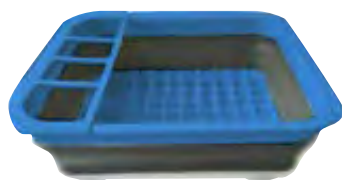

COLLAPSIBLE SINK DRAINER

044902

A great bench space saving idea, this collapsible dish tray is a great addition to your home, campsite or caravan. It can be used to stack dishes for drying.

FEATURES

- Suitable for plates up to 280mm in diameter
- Fully collapsed height of only 55mm

SPECIFICATIONS

- Colour: blue



COLLAPSIBLE SINK COLANDER

044903

FEATURES

- Ideal for camping or caravan kitchens
- Space saving storage solution

SPECIFICATIONS

- Colour: blue



COLLAPSIBLE TUB

044906

FEATURES

- Great for space saving storage when caravanning or camping
- Ideal for washing dishes

SPECIFICATIONS

- Colour: blue



FOLDABLE DISH DRAINER

041605

Folds flat for easy storage.

SPECIFICATIONS

- Dimensions: 295mm(h) x 320mm(w) x 80mm(d) collapsed



CAMEC EGG CONTAINER

042667

Holds 12 eggs.

Keeps eggs safe while travelling. Each compartment has been designed to cushion & won't crush the eggs when closed.

PEGLESS CLOTHESLINE

050571

Now hanging your washing is fast and easy. No more fiddling with pegs! Easy on, easy off. Simply slide your washing into the slots to dry.

Ideal for drying all your family laundry – babies and children's clothing, cloth nappies, jeans and towels. Perfect for indoors and outdoors, at home, camping or travelling.

FEATURES

- 1 x Packet = 2 metres of pegless washing line and 2 bungee cords, 12 slides and 24 points





SMARTSPACE POTS WITH LIDS

040367

SmartSpace cookware not only saves space on the cooktop, it also saves space in your cupboards! SmartSpace was designed to stack. Each pot stacks neatly inside the next & the revolutionary handle is removed & stored at the click of a button. SmartSpace cookware can also be used to store food in your fridge.

FEATURES

- Pots, lids, handle all stack inside one another for easy storage
- Teflon non-stick coating
- Custom silicone mats for stacking & use on bench-top
- Unique shape to fit on stoves
- Pots will also stack in frypan. Frypan sold separately (refer code 040368)
- Induction compatible

SPECIFICATIONS

- 3 x SmartSpace pots, 2.8, 1.9 & 1.4Ls (3 quarts, 2 quarts, 1.5 quarts)
- 3 x matching lids
- 3 x custom silicone mats
- 1 x removable handle
- 1.4Lt Pot - 160mm x 160mm x 105mm
- 1.9Lt Pot - 185mm x 185mm x 125mm
- 2.8Lt Pot - 210mm x 210mm x 140mm



SMARTSPACE FRYPAN

040368

FEATURES

- Heavy duty 3mm aluminium walls
- Impact bonded heat transfer & induction base
- Quality enamel finish

SPECIFICATIONS

- 1 x fry-pan
- 1 x detachable handle
- 1 x custom silicone mat
- Dimensions: 215mm(w) x 250mm(l) x 55mm(d)
- Lid sold separately (refer code 041051)



SMARTSPACE FRYPAN LID ONLY

041051

Frypan lid for use with SmartSpace frypan.

FEATURES

- Protection from spatter



SMARTSPACE COOKWARE HANDLE

040858

Stylish detachable handle for use with SmartSpace cookware.



CLOCK

000356 SILVER

000357 GOLD

Battery operated wall clock.

FEATURES

- Quartz movement
- Large black numbers
- Sweeping second hand
- Available in 2 styles - silver or gold surround with white face
- Quiet operation

SPECIFICATIONS

- Glass face cover dimensions: 100mm diameter
- Batteries not included
- No less than 3mm ply required
- Cut out required: 79mm



DAMP RID REFILL

035470

Damp rid moisture absorber lasts up to 60 days depending on temperature & humidity.

FEATURES

- Protects against damp, mildew & rust
- 1.19kg



DAMP RID STARTER PACK

035473

Damp rid moisture absorber lasts up to 60 days depending on temperature & humidity.

FEATURES

- Protects against damp, mildew & rust
- 300g



ALCOHOLDER STEMLESS INSULATED TUMBLER

- 050243 AQUA MIST
- 050244 UNICORN SPARKLES
- 050245 ULTRA VIOLET
- 050341 CEMENT GREY MATTE
- 050826 ROSE GOLD
- 050827 CHARCOAL

- 050828 BLUSH PINK
- 050829 MARBLE WHITE
- 051599 LEOPARD
- 051600 FADE GREY/ALPINE
- 051601 FADE GREY/BEACH GLASS
- 051602 MATTE CEMENT BLACK

Shaped for comfort and designed for practicality, the ALCOHOLDER Stemless Insulated Wine Tumbler will lovingly take care of just shy of half a bottle of wine at a time (355ml) and keep it cool for up to 12hrs. What's neat is it'll also handle hot drinks and keep them that way for up to 6hrs. Constructed of BPA-free food grade stainless steel, the tumbler features a splashproof slide-open lid.

SPECIFICATIONS

- Glitter Iridescent or matte painted finish
- Slide-open lid with double silicone seal
- Stainless steel
- Vacuum insulated
- Keeps drinks cold for 12hrs, hot for 6hrs
- Perfect for: wine, tea & coffee, mixers
- Dimensions: 90mm (w-lower) x 80mm (w-upper) x 110mm (h)
- Care Instructions - The slide part of the lid is not designed to be removed. We recommend soaking the lids in warm soapy water and running water through it after the soak
- Gift boxed



ALCOHOLDER 5 O'CLOCK STAINLESS TUMBLER

- 050250 MATTE SEAFOAM GREEN
- 050251 MATTE BLACK
- 050252 STAINLESS STEEL

- 051603 GLITTER BLUSH PINK
- 051604 STORM BLUE

Your AM/PM best friend. Perfect for the morning pick me up or something a little more exciting in the PM. The 5 O'Clock Tumbler will keep your drinks icy cold or piping hot for 12hrs and 6hrs respectively. Made from BPA-free food grade 18/8 stainless steel, each tumbler is vacuum insulated and includes a slide-close lid.

SPECIFICATIONS

- Vacuum insulated. Slide-lid
- Hot for 6hrs, cold for 12hrs
- 590ml (20oz) capacity
- Bottom circumference width of the 5 o'clock is 7cm - the cup tapers out to 8.5cm gradually with a cup height 17 cm (inc. lid 17.5cm)
- Available in matte black, matte seafoam green and stainless steel
- Gift boxed



ALCOHOLDER STUBZERO COOLER

- 050830 SEAFOAM GREEN
- 050831 BLACK
- 050832 STAINLESS SILVER

- 051611 BLUSH PINK
- 051612 STORM BLUE

Stubzero will help you keep your cool for longer. Heavy duty double walled vacuum insulated stubby cooler that keeps drinks colder for longer. Condensation free to keep your hands dry. Top gasket allows the fitment of various sized cans / bottles.

SPECIFICATIONS

- Vacuum insulated
- Condensation free
- Up to 5 times colder @ 1 hour compared with a regular stubby cooler
- Material: 18/8 food grade stainless steel
- Fits: Cans - 355/375ml, Bottles - 330/345/355/375ml
- Dimensions: 7.8cm (w) x 13.3cm (h)
- Gift boxed



ALCOHOLDER SKNY STAINLESS TUMBLER

- 050822 UNICORN SPARKLE
- 050823 AQUA MIST
- 050824 ROSE GOLD
- 050825 BLUSH PINK

- 051605 FADE GREY/FIREFLY
- 051606 LEOPARD
- 051607 FADE GREY /BEACH GLASS

SKNY is minimal and stunning in design. Cup holder friendly yet is able to hold 590ml (20oz) of your favourite beverage. Complete with Stainless Steel 8mm eco straw, SKNY will keep your drinks icy cold or hot for 12hrs and 6hrs respectively. Each tumbler is vacuum insulated and includes a straw friendly sip-thru clear lid. Perfect for: cocktails, spritzers, smoothies, ice tea, juices, protein shakes, water coffee, tea and more!

SPECIFICATIONS

- Vacuum insulated
- Sip-through lid
- Condensation free
- 8mm bent stainless steel straw
- Glitter Iridescent finish
- Cold for 12hrs, hot for 6hrs
- Material: 18/8 food grade stainless steel
- Capacity: 590ml (20oz)
- Dimensions: 7.5cm (w) x 21cm (h) (25cm in straw)
- Gift boxed



ALCOHOLDER SPILL PROOF WINE CUPS

050246 SEAFOAM GREEN

050247 RUBY PINK

050248 CRYSTAL CLEAR

050249 BLUE

Ever felt like a sneaky wine on the go, but just can't work out what to put it in? Not only does this clever little vessel actually look somewhat like a wine glass, it'll also keep bugs and debris out of it with its removable lid. The lid also has a closable opening much the same as a portable coffee cup. Made of BPA free acrylic.

SPECIFICATIONS

- 295ml capacity
- Double wall insulated
- Lid with closure
- BPA free
- Available in seafoam green, ruby pink, crystal clear, blue
- Gift boxed



ALCOHOLDER TANKD MUG W/HANDLE

051608 MATT BLACK

051609 BLUSH PINK

051610 STORM BLUE

Looking to get a handle on life and score some extra D whilst doing so? Sometimes drinks can be a little hard to handle. Enjoy the next frontier in beer with TANKD. Practical from top to bottom, TANKD features a twin-sealed slide close lid up top and a stainless steel base. Whether it be coffee in the AM, or something to make you chill in the PM, all 475mls of it can be found here in your mug, tankard, whatever you want to call it. All we know is, it is time to get TANKD. For the love of the D, get a grip!

SPECIFICATIONS

- 475ml - 16oz
- Vacuum Insulated
- Keeps drinks cold for 12hrs, hot for 6hrs
- Powder coated finish
- Slide-open lid with double silicone seal
- 304 Food Grade Stainless Steel
- Perfect for: Beer, Tea & Coffee, Mixers
- Dimensions: 8.5cm (w) (12cm inc handle) x 13cm (h)
- Care Instructions: Tumbler - Hand wash; Lid - Top rack dishwasher or hand wash (The slide part of the lid is not designed to be removed. We recommend soaking the lids in warm soapy water and running water through it after soaking)
- Replacement Lids are available for purchase
- Gift boxed



ALCOHOLDER SQUISH SILICONE STEMLESS WINE TUMBLERS

051613 WHITE

051614 BLACK

Super flexible, unbreakable, party safe stemless wine glasses in a handy 2 pack drawstring carry bag.

Sun is shining, drinks are on the cards, grab SqUish and go!

SqUish stemless wine tumblers love to join you when out and about or relaxing at home. Fancy a dip? SqUish loves the water too. Don't worry about SqUish breaking at your next event, they are party safe without the worry of broken glass around. Compact, flexible and lightweight.

SqUish is an essential item for around the pool, at the beach, travelling in the caravan, winery visits, picnics, parties, events and more!

Packed neatly in a 2 piece storage bag, SqUish can go everywhere and be there for you when needed. Easy to carry, light for travel and packing. Sip with SqUish.

SPECIFICATIONS

- 55ml capacity (12oz)
- Available in Black (2 pack) and White (2 pack)
- Smooth silicone finish
- Food grade silicone
- Perfect For: Wine, Mixers, Cocktails
- Dimensions: 85mm x 85mm x 106mm - 96g
- Ideal for storing in beach bags, picnic baskets, caravans and boats(h)



ALCOHOLDER INSULATED FLASK

050342 UNICORN SPARKLES

050343 AQUA MIST

050344 ULTRA VIOLET

050345 CEMENT GREY

Ready to serve and protect, the ALCOHOLDER Flask will engulf an entire 750ml bottle of wine and will maintain the temp for a whole 24hrs. Featuring a sealed leak-proof lid, it is the wine bottle where no one bottle has gone before, it is practically glass-less.

SPECIFICATIONS

- Glitter iridescent or matte painted finish
- Leak-proof lid with seal
- Stainless steel
- Vacuum insulated
- Cold for 24hrs
- Perfect for: wine, tea & coffee, mixers, water
- Dimensions: 7.6cm (w) x 31cm (h)
- Gift boxed

CAMPING



FRONT OPENING JERRY CAN HOLDER

050032

Holder suits 20L jerry can.

SPECIFICATIONS

- Inside dimensions: 370mm(h) x 180mm(w) x 295mm(d)
- Weight: 3.4kg
- Zinc plated



ARK TOP LOADING JERRY CAN HOLDER

039990

SPECIFICATIONS

- Heavy powder coated steel construction
- Mounting points all four sides & base
- Rubber protector pads all four sides & base
- Anti-theft adjustable locking bar
- Petrol siphon protector
- Built in adjustable straps to prevent rattling
- Holds jerry cans up 355mm(w) x 180mm(d) x 477mm(h)



JERRY CAN HOLDER - PLATED

000593

Welded steel bracket to suit 20L jerry can. Keeps jerry can safe while travelling.



ARK 20LT JERRY CAN HOLDER BLACK

050424

Front opening.



DRUM TAP FINE 3/4" THREAD

006214

Lever type.



JERRY CAN TAP

000602

Fine thread PVC tap to suit jerry can code 000604.



20LT PVC JERRYCAN DRINKING WATER ONLY

000604

The space saving design of this plastic drinking water can is very functional & fits standard camper racks.

FEATURES

- Embossed pattern provides a slip resistant surface
- Australian made
- Compatible with most available spare parts

SPECIFICATIONS

- Dimensions: 510mm(h) x 170mm(w) x 330mm(d)
- Weight: 1.0kg
- Lid opening: 58mm
- Bung: 3/4"



25LT DRUM CUBE WITH BUNG

035246

Food grade cube plastic drum with screw cap & handle for brewing, camping, water storage & chemical storage.

SPECIFICATIONS

- Material: high density polyethylene HDPE
- Volume: 25Lt
- Dimensions: 440mm(h) x 280mm(w) x 280mm(d)
- Weight: 1150g
- Lid opening: 58mm
- Bung: 3/4"



FUEL DRUM 20LT PVC

040820

Fully approved container for fuel.

SPECIFICATIONS

- 20Lt red



DIESEL DRUM 20LT PVC

040821

Fully approved container for diesel.

SPECIFICATIONS

- 20Lt yellow - diesel



RED PLASTIC ULP FUEL CAN 5LT

050256

PQ 5L-ULP-RED Pro Quip.

HAIR DRYER**000772**

Portable 12V hair dryer which plugs directly into car accessory socket.

FEATURES

- High quality plastic body with adjustable head

SPECIFICATIONS

- Cable length: 1.2m
- Power: 12V DC
- Power consumption: 220W 18.3A
- Includes fuse for safety
- Minimum 20A fuse is required in car wiring to run this unit

**TURBO SHOWER KIT****005808**

Plugs into the car accessory socket.

FEATURES

- Complete with pump
- 2.13m plastic tubing & carry bag
- Suction cap & s-hook included for hanging
- Water pressure adjustable with shower rose

SPECIFICATIONS

- Voltage: 12V
- Weight: 1.5kg
- 12V car plug & long lead

**TABLE UTILITY 400 X 500MM****038374****FEATURES**

- Aluminium frame
- MDF top
- Foldable table for easy storage & transport
- Quick & easy to set up

SPECIFICATIONS

- Dimensions: 380mm(w) x 530mm(l) x 620mm(h)

**ALUMINIUM TABLE MDF TOP****043567**

Compact & lightweight in design, this folding table has an MDF top & brushed aluminium legs & folds easily.

FEATURES

- Sturdy MDF top
- Wood grain finish
- Quick & easy to set up

SPECIFICATIONS

- Folded size: 800mm(l) x 600mm(h) x 50mm(d)
- Assemble size: 800mm(l) x 600mm(h) x 700mm(d)
- Weight: 3.5kg

**BAMBOO CARAVAN TRAVEL MUG - RETRO PATTERN****050579 AQUA****050580 RED****050581 SKY****050582 YELLOW**

Australian-designed caravan Bamboo Travel Mugs have a unique re-sealable screw top bamboo lid with no-drip silicone lid locker and a silicone sleeve for extra heat protection. Designed especially for hot liquids, they are perfect to take with you wherever you go, whether you're travelling, or just entertaining with family and friends.

SPECIFICATIONS

- FDA (USA) & LFGB (Germany) food safe approval certification
- BPA and phthalates-free
- No taste transfer like you can get from some plastics
- Durable and lightweight
- Suitable for hot and cold food or drinks
- Dishwasher safe
- Not suitable for microwave or oven use
- Designed in Australia
- Features images of classic by-gone travel homes



CAMP FORKS

044054

Retractable toasting fork ideal for camp fires. Extends to 860mm.

FEATURES

- Cushion grip handle
- Stainless steel
- Heavy duty

SPECIFICATIONS

- Extends from 260mm to 860mm



COMPRESSOR WITH BAG

035334

Compact size, 12V, twin motor with automatic stop. 14 amp power draw. Suits trucks & 4x4s.

FEATURES

- Durable fabric carry bag allows for easy transportation
- Vibration minimising rubber footing
- Handle on compressor itself for movement outside the bag
- Flexible rubber neck
- Various nozzles & long power lead supplied

SPECIFICATIONS

- Voltage: 12V
- Working Current: Maximum 23amp
- Twin motor - auto stop preset gauge
- Flow rate: 35Lt/pm min displacement
- Maximum pressure: 150psi



EXPANDABLE LAUNDRY BAG

050577 YELLOW

Carry your laundry in style with this expandable laundry bag with gorgeous Aussie designed illustrations. Two sizes in one.

Expandable laundry bag, two sizes in one. 70cm x 50cm, expands to 90cm x 50cm.

Features caravan and washing line illustrations printed on 100% rip stop nylon.

Cold gentle machine washable.



EXPANDING HOSE

044464

Automatically expands to 50' and contracts. Compact, lightweight and simple to store.

FEATURES

- Nozzle included
- No more kinks!
- Automatically expands



FOLDING SHOVEL

050042

FEATURES

- Comes with carry bag

SPECIFICATIONS

- 580mm open



FOLDING STOOL

041585

SPECIFICATIONS

- Dimensions: 420mm (W) x 300mm (D) x 400mm (H)
- Max load: 110kg
- Ultralight



VERTICAL STAYPUT

050348 WHITE

050349 BLACK

Stayput T-Toggle with metal flipper, vertical fixing.

The durable anti-rust canvas fastener/ stay put with endless uses! This connection accessory is ideal between canvas and metal, plastic wood, etc. Great to have on hand when boating, off-roading or camping.



HORIZONTAL STAYPUT

050350 WHITE

050351 BLACK

Stayput T-Toggle with metal flipper, horizontal fixing.

Durable canvas fasteners for boats, caravans, and tents. Single fasteners take one eyelet.



HOT DEVIL POCKET TORCH

042715

042716 BUTANE GAS REFILL

Butane Weld Torch. Refillable with purified butane gas.

FEATURES

- Auto ignition
- 20 minutes burn time
- Torch temp. 1300°C
- Adjustable flame control
- Ideal for soldering, splicing with heat, camping, lighting coals/heat beads, plastic welding, loosening rusted nuts, bolts & screws



HOT DEVIL FLEXIBLE LIGHTER

039892

Flexible stem, refillable lighter with adjustable flame & safety lock.



ROOF RAIL BRACKETS

050038 STAINLESS

050039 WHITE

051473 BLACK

Stainless steel roof rail bracket for mounting poles. Also available in black or white.

Having a few of these strong mounting brackets handy in your kit, you can be assured that your roof raptor can be erected securely, and you are prepared if you need any replacements.



LITTLE GRIPPA 5MM

050338

Classic reflective bungy material.

SPECIFICATIONS

- Dimensions: 5 x 600mm long
- Pack quantity: 4
- Reflective material

UV Resistant, maintaining colour fastness despite exposure to outdoor elements.

Wear & tear resistant retaining 100% stretch and recovery despite regular use.

Safe, fast and easy to use – Little Grippas are fully adjustable cords and allow for quick release when needed. Our customers are loving these – on the bike, on the trailer, around the rolled-up camping mattress, great for tents, marquees, banners, sail ties on the boat, on the beehive, in the car, around the Christmas tree, on the farm.



LITTLE GRIPPA 8MM

050339

Vivid yellow non-reflective bungy material.

SPECIFICATIONS

- Dimensions: 8mm x 100mm long
- Pack quantity: 2
- Non-reflective



LITTLE GRIPPA 8MM REFLECTIVE

050340

Classic reflective bungy material.

SPECIFICATIONS

- Dimensions: 8mm x 100mm long
- Pack quantity: 4
- Reflective



SHOCK CORD ABSORBER

050352

FEATURES

- Cushions & protects
- Elastic
- Weather resistant
- 6mm x 240mm
- Packet of 2



SHOCK CORD KNOB

050041

The plastic knob is extremely strong and well made. Smooth and rounded matt finish. Works in conjunction with shock cord loop (sold separately). Quality matt black colourfast plastic.



SIROCCO FAN 12/24V

050884 WHITE
050977 BLACK

This cabin fan can be mounted to any surface with the gimbaled design enabling airflow to be moved in any direction. The 12V / 24V operation of the Sirocco II makes it ideal for boat and caravan installations.

FEATURES

- 3 speed fan with ultra quiet operation
- Can be folded flat against the bulkhead when not in use
- 4 preset timer settings with timer indicator lights

SPECIFICATIONS

- Dimensions: 180mm diameter
- Power: 12V / 24V
- Warranty: 2 Years



OSCILLATING MARINE FAN 12V

000791

FEATURES

- Plastic blade
- Electroplated fan shield
- 60 degree "sweep" motion

SPECIFICATIONS

- Dimensions: 220mm(l) x 170mm(h) x 140mm(d)
- Weight: 600g
- Blade size: 150mm
- Current: 1.2amp
- 1.4 metre cord



MINI FAN HEATER 12V

000625

Mini 12V fan heater plugs directly into the vehicle's accessory socket to provide a powerful auxiliary heat source & windshield defroster. Has an adjustable swivel stand for directional heat flow & automatic temperature control.

FEATURES

- Durable long-life ceramic heating element
- Switch for heat or fan only operation
- Mount anywhere with hook & loop adhesive tape or screws (included)
- Adjustable angle puts heat where you want it

SPECIFICATIONS

- Dimension: 70mm(l) x 200mm(h) x 290mm(d)
- Weight: approximately 500g
- Power: 12V
- Power consumption: 150W 12.5amp



BUG ZAPPER "ENFORCER"

044505

Is a compact yet robust bug zapper that's perfect for small entertaining spaces. This units clever design allows it to be hung or placed on flat surfaces. Its vertical grid means dead bugs drop directly into the units catcher tray. It features a power saving 10W UV lamp housed in a weatherproof casing. Attracted pests include mosquitoes, moth & midges - pests that are most active from dusk till dawn.

SPECIFICATIONS

- Dimensions: 14cm (w) x 26cm (h) x 14cm (d)
- 10W
- 240V



WATER SAVING BUCKET 11LT

039893

Space saving folding water bucket. It rises as it fills.

FEATURES

- Capacity: 11Lt
- Folds away flat

BOOKS & MAPS

MAKE TRAX ACROSS THE TOP

043117

Escape to Australia's tropical north with confidence using the information & advice packed into this handy guidebook. Memorable destinations merge into the next as your wheels roll across the top through simply stunning country.

Follow the sun from Cairns to Broome by any of the routes described; there are options for passenger car travellers, motorhomers & caravanners, together with more demanding 4WD expeditions off the beaten track.

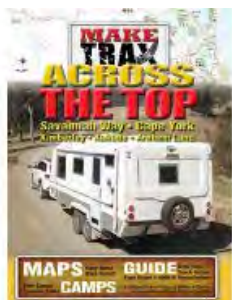

AUSTRALIAN ROAD & 4WD TOURING ATLAS RING BOUND SPINE

044735

This brand new edition of Hema's best-selling Australian road atlas now features 188 atlas pages in a stunning new cartographic style. Every atlas in the range now includes maps for 4WD & touring destinations such as Cape York, Fraser Island, the Top End, the Kimberley, the Pilbara, Central Australia, High Country Victoria & the Flinders Ranges. Additional maps also provide more detailed coverage for the country's busy coastal strips.

SPECIFICATIONS

- Published: December 2017
- Pages: 224
- Dimensions: 350mm(l) x 250mm(w)
- Weight: 1.8kg

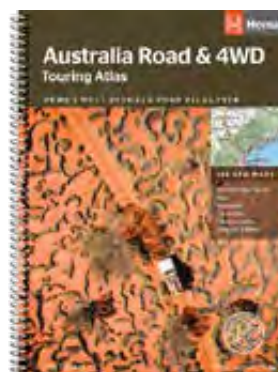

CAMPS AUSTRALIA WIDE V11

051261

Australia's favourite guide for freedom and low-cost camping – owned by an Aussie family and printed in Australia. We welcome you to our community of travellers across Australia. Almost 30 years of travel, research and knowledge has been transferred into our easy-to-use guides.

NEW FEATURES

- New site type symbols on the maps
- For the first time in the history of CAMPS, you can identify the site type at a glance on the maps.
- Without looking at the listing, you can see if it is pet friendly or a camp at a showground, national park, station or pub stay, state forest, RV park or other freedom or paid site.
- More facilities in the listings.



TRAVEL JOURNAL

050570

Whether you enjoy occasional overnight stays, weekends away, international adventures, months of adventures on the road or even sleepovers – The TRAVEL JOURNAL is packed with 92 journal pages to document your daily experiences.

Draw, write or attach a photo. The kids (and grown-ups) in your family will have a wonderful time documenting the highlights and happenings of each and every day (and looking back on the memories in the months and years to come) – wire bound with a protective plastic sleeve.



CARAVAN / CAMPER LOG BOOK

050569

The Caravan/Camper LOG BOOK is an A5 2 part book that will help you keep track of the places you stay and the kilometres that your caravan or camper trailer does.

The front part of the Caravan/Camper LOG BOOK allows you to note down where you stayed, rate it and jot down some notes that you can refer to later.

The back part allows you to keep track of the kilometres the caravan or trailer travels. We have added a FUEL column too and it is endorsed by the Caravan Industry. We found we would set up at a park, and then drive around taking in the sights...but then we would lose track of how many km's our van was doing. For re-sale and servicing, this information can come in very handy.



MAKE TRAX FREE CAMPS 2

050292 WITH ATLAS

Make Trax FREE Camps Australia is the essential guide to Australia's free and low cost camp sites. With over 4765 free and budget sites around Australia listed and 3267 described, Make Trax FREE Camps with Australia Atlas contains everything you need to know to prepare for a fantastic journey of discovery into Australia's great outdoors.

This book will help ensure you travel safely, confident in knowing where you are going and where you can camp on your journey. Detailed up-to-date notes are provided on campsites as well as GPS coordinates. Points of interest at locations are highlighted as well as cities, towns and key topographical features like rivers and creeks. Also included is an updated Australia Atlas that features major highways, roads, tracks and arterials to help ensure you get to wherever you want in the Australian outdoors. This atlas features the highest detail in the outback areas of Australia.



GO TO GUIDE FOR CARAVAN

050622

From windswept grey nomads to sun kissed newlyweds, Hema's Go-To Guide for Caravans is a vital companion for every kind of caravan-hauling holiday maker. Everything the reader will need to know is presented in an easy-to-read format, with plenty of info-graphics and Hema maps, and advice from an extensive network of industry-leading experts.

The Go-To Guide covers:

- Trip planning
- Preparation
- Equipment & Gadgetry
- Maintenance & DIY
- Safety & Security
- Food & Frivolities
- Inspiring Destinations



TIE DOWNS



STEEL TENT PEGS

035218

Pack of 10.

SPECIFICATIONS

- Dimensions: 225mm(l) x 6.3mm(d)

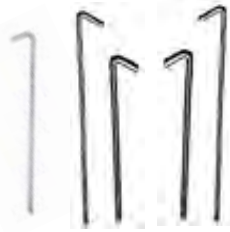

ANNEX STEEL PEG

001722 - 300 X 8MM

001723 - 350 X 9.5MM

001724 - 450 X 11.2MM



TENT PEG PULLER

050040

43cm long.



TENT POLE CAMLOCK

001716 - 2300MM

Aluminium.



ANNEX POLE PLATE BLACK PLASTIC

001718

Prevents pole movement & provides solid base for poles.



GUY ROPE SLIDE & TRACE SPRING

001731

Suitable for annexes.

GUY ROPE KIT INCLUDES

- 6mm rope
- Spring
- Heavy-duty wood slide



TENT POLE CONTAINER 2000MM

035220

SPECIFICATIONS

- Dimensions: 2000mm(l)
- Weight: 7.0kg
- DIA: 150mm
- Inc 2 brackets
- Access for both ends



ANNEX POLE CONTAINER FIXED CAP

000509

Replacement fixed cap for Annex pole container (refer to code 000505).



ANNEX POLE CONTAINER 2185MM

000505

Ideal for storing poles, TV masts, fishing rods, etc.

SPECIFICATIONS

- Complete with 2 bracket assembly & hinged lockable lid
- Weight 2185mm: 6.3kg
- DIA: 150mm
- Inc 2 brackets



ANNEX POLE CONTAINER BRACKET SINGLE

000506

Annex pole container complete bracket assembly.

SPECIFICATIONS

- Dimensions: 150mm(l) x 150mm(h) x 10mm(d)



ANNEX POLE CONTAINER HINGED LID

000508

Replacement hinged lid for Annex pole container (refer code 000505).



ANNEX ADJ SLIDE RAIL

001695 1220MM

001696 1830MM

001697 2440MM

19mm steel adjustable slide rail. Each rail has a hole in each end to engage spigot of wall pole to create annex frames.

SPECIFICATIONS

- Australian made galvabond tube



ANNEX ADJ WALL POLE

001691 2300MM

001694 2750MM

SPECIFICATIONS

- Adjustable 19mm steel wall pole

**DIECAST ROPE CLEAT - 90MM**

001687

FEATURES

- 90mm die-cast cleat often used to secure annex roof slide rope

**DIECAST ROPE LASHING HOOK**

001686

Lashing hooks used to tension & tie down equipment such as tonneau covers & tarpaulins.

**PLASTIC SIDE RELEASE T-DOWN 25MM**

016912

SPECIFICATIONS

- 50kg lashing capacity
- Supplied as a pair
- 2.5m

**POPTOP TENSIONER 260MM**

008430

Plastic tensioner & rubber band.

SPECIFICATIONS

- Inserted into pop top sleeve to assist in lowering the roof

**HOLD ON UNIVERSAL EYELET**

042665

Pack of 2.

Temporary support for securing tarps and privacy screens. Simple to use and holds strong throughout any weather conditions.

**CAMBUCKLE TIE DOWN 25MM X 1.8M**

040796

FEATURES

- Features a soft loop allowing the fixtures to stay tight without marking your cargo
- Complies to voluntary safety standards AS/ NZS 4380 in Australia & New Zealand
- Instant release with thumb pressure

SPECIFICATIONS

- Lashing capacity: 270kg
- Pack of 2

**CAMBUCKLE TIE DOWN 25MM X 3.6M**

040797

FEATURES

- Features a soft loop allowing the fixtures to stay tight without marking your cargo
- Complies to voluntary safety standards AS/ NZS 4380 in Australia & New Zealand
- Instant release with thumb pressure

SPECIFICATIONS

- Lashing capacity: 270kg
- Pack of 2

**RATCHET TIE DOWN 25MM X 3.6M**

040799

FEATURES

- Tightens down with vice like gripping power for heavy duty applications
- Rubber coated levers & hooks for comfort & to minimise wear on surfaces
- Complies to voluntary safety standards AS/ NZS 4380 in Australia & New Zealand

SPECIFICATIONS

- Lashing capacity: 450kg
- Pack of 2

CLEANERS



CANVAS REPAIR TAPE WHITE

044142

A quick & efficient method of repairing holes & tears in canvas.

SPECIFICATIONS

- 48mm x 4.5m roll



VINYL REPAIR TAPE

050020

Suitable for vinyl & vinyl coated products. Vinyls have oils that are absorbed by most adhesives which causes the adhesive to turn gooey, gummy, & ultimately lose bond. Tear-Aid vinyl repair patches contain an inhibitor that blocks the oils found in vinyls resulting in a long lasting repair.

SPECIFICATIONS

- 75mm x 300mm
- Cleaner plus small patches included



BIRKMYRE WATERPROOFING

001622 2LT BOTTLE

001623 5LT BOTTLE

Waterproofs aged canvas.

FEATURES

- Helps repel mildew
- Extends canvas life

SPECIFICATIONS

- Coverage: 6 square metres per litre



ENVIRO WATERLESS WASH

050070

500ml. Specifically formulated for the speedy removal of surface contaminants without rinsing, simply spray & wipe off.



PREMIUM RV SHAMPOO

050071

500ml. PH-neutral shampoo used on RV's with RVgard premium paintgard.



TINT SAFE GLASS CLEANER

050072

500ml. Specifically formulated to clean glass without damaging the tint film.



VINYL & RUBBER REVIVER

050075

500ml. Designed to shine and protect vinyl & plastic surfaces.



RV GARD PREMIUM WAX

050353

500ml. Contains high tech polymers, carnuba wax and resins to create a deep shine. Suitable for RVgard paint protected surfaces.



SURFACE REJUVENATOR

050073

100ml. High grade polish designed to remove small stubborn stain areas. Suitable for RVgard paint protected surfaces.



BUG & TAR REMOVER

050074

100ml. Rapidly removes bugs, tar and other contaminants. Suitable for use with RVgard paint protected surfaces.



TV & ANTENNAS

- Televisions 22
- Television Mounting Brackets..... 26
- Antennas..... 27
- Antenna Accessories & Spares 28
- Speakers 31
- Audio Accessories 31

TELEVISIONS



RV MEDIA 19" LED HD TV/DVD/PVR 044477

Features included standard on RV Media Evolution series 19" TV's are Low RV Battery Voltage Warning, 2 x HDMI inputs, our Exclusive Backlit Remote control, RCA & headphone Audio outputs and more!

SPECIFICATIONS

- Screen Size: 19" (47cm)
- Panel Resolution: 1366 x 768 Pixels
- Contrast Ratio: 1000:1
- Response Time: 14ms
- Viewing Angle: 178(h) x 178(v)
- Display Type: LED
- Aspect Ratio: 16:9
- Speakers: 2 x 3W
- No stand included
- HD Modes: 480i, 480P, 576i, 576P, 720P, 1080i, 1080P
- Dimensions (excluding base): 440 x 263 x 50mm
- Dimensions (including base): 440 x 299 x 139mm
- Net Weight: 2.3kg
- Wall Mount: 100 x 100
- Operating Voltage: 10-30V

ON SCREEN LOW BATTERY VOLTAGE WARNING

Low RV Battery voltage can not only potentially damage your 12V equipment, it may also reduce battery life.

To ensure this does not happen while watching TV, RV Media Evolution Series TV's will display an on screen low battery voltage warning message when the system voltage drops below 11V. In addition to this, RV Media Evolution TV's are designed to operate on a wide 10-30 Volt Range to ensure reliable operation in the most adverse conditions.

BACKLIT REMOTE WITH QUICK TUNE

Our exclusive backlit remote control ensures easy TV operation without the need to turn on the RV's lighting and disturb other people. The remote is even compatible with Series 3 RV Media TV's!

While travelling, it is advisable to re-tune your Digital TV Channels (DTV) when visiting a new town or area. The process is now easier with RV Media's QT button. Simply press the dedicated QT button on the remote to start the DTV tuning function.



OPTIONAL STAND AND PLUGPACK FOR 19"

051702

As most RV TV's are mounted on the wall and operate from the RV's 12V system, RV Media Evolution Series TV's are not supplied standard with a stand and 240V plugpack that in most cases are not used.

This ensures that this Premium TV is produced using only A-Grade LCD panels and premium components that have been specifically sourced and developed for the Australasian RV environment.

Should you require a desk-top stand or 240V plugpack, please order one of the appropriate TV Accessory Kits.



RV MEDIA 24" LED HD 8G SMART TV

051263

The RV Media 24" TV has taken the next steps in defining how you watch TV while out caravanning or camping. This Full High Definition TV gives you the highest quality pictures so you can enjoy all your favourite releases while having all the technology and functionality like your TV at home.



INPUT

- HDMI x 2
- USB 2.0 x 2
- RJ45 x 1
- A/V x 1

OUTPUT

- Line Out x 1
- Co-axial Digital x 1
- Headphones x 1

DIGITAL SPECIFICATIONS

- Screen Size 24" (61CM) USB PVR Function with time shift
- Panel Resolution (Pixels) 1920 X 1080 USB multimedia playback
- Bluetooth Wireless Audio
- Inbuilt DVD player
- Closed Captions
- Full HD DVB-T Digital TV Tuner
- Sleep Function
- Auto TV Tuning Quick Tune TV
- Autotune button
- Low battery Voltage Warning

SMART TV SPECIFICATIONS

- Android 9.0 Operating System
- 8GB Flash Memory
- 1GB DDR3 RAM
- Quad-Core Cortex A-53 CPU
- Terrestrial Antenna x 1

SPECIFICATIONS

- Dimensions (Excluding feet): 552mm x 325mm x 54mm
- Dimensions (Including feet): 552mm x 361mm x 176mm
- Net Weight: 3.7kg
- Aspect Ratio: 16:9
- Contrast Ratio: 3000:1
- Viewing Angle 176(h) x 176 (v)
- Response Time 8.5ms
- Speakers 2 x 3W
- Display Type LED
- Operating Voltage: 10 - 30V
- Wall Mount: 100 x 100 (Screw suggested 6 x 10mm)

FEATURES

- Smart remote control
- DVD Player
- Low RV battery voltage warning
- 2 x HDMI inputs
- New and improved Smart TV platform
- RCA & headphone audio outputs
- Bluetooth wireless audio
- Smart TV
- New TV remote with "virtual mouse button" to make it easier while surfing the Net

*No 240v lead included. No stand. Available in Accessories Pack 051808



RV MEDIA 32" LED HD 8G SMART TV

051220

The RV Media 32" TV has taken the next steps in defining how you watch TV while out caravanning or camping. This Full High Definition TV gives you the highest quality pictures so you can enjoy all your favourite releases while having all the technology and functionality like your TV at home.



- CVBS OUT x 1
- USB 2.0 Output x 2
- RJ45 Input x 1
- 12V & 240V leads included
- Android 9.0
- Flash Memory 8GB
- ADR3 RAM 1GB
- Processor-Quad-Core Cortex A-53

FEATURES

- Backlit remote control
- Low RV battery voltage warning
- New and improved Smart TV platform
- RCA & headphone audio outputs
- Bluetooth wireless audio
- Smart TV
- New TV remote with "virtual mouse button" to make it easier while surfing the Net

SPECIFICATIONS

- Screen Size 32" (80cm)
- Panel Resolution (Pixels) 1920 x 1080
- Bluetooth Yes
- Contrast Ratio
- Response Time 8ms
- Viewing Angle 178(h) x 178(v)
- Display Type LED
- Aspect Ratio 16:9
- Speakers 2 x 8W
- HD Modes 480i, 480P, 576i, 576P, 720P, 1080i, 1080P
- Dimensions (Excluding feet): 732mm x 434mm x 80mm
- Dimensions (Including feet): 732mm x 477mm x 211mm
- Net Weight: 4.5kg
- Conversion kit available to suit standard 100 x 100mm mounts 043042
- Wall Mount: 200 x 100 (Screw suggested 6 x 10mm)
- Operating Voltage: 10-30V



RV MEDIA REMOTE SUIT SERIES 2 043743

Suits RV Media 042701 Series 2, 24" TV only.



RV MEDIA REMOTE SUIT SERIES 1 044574

Updated Version – Suits 041433, 041436, 041969 & 041437 TV's.



REMOTE BACKLIT SERIES 3 & EVOLUTION 044573

Suits RV Media TV's Series 3 – 19", 22", 24" plus 28" & 32" (non-Smart TV's), and Evolution 19", 22" & 24" TV's.



REMOTE WEATHER RESISTANT 044064

For RV Media TVs Series 3 - 19", 22", 24" and the 28" and 32"



RV MEDIA SMART REMOTE CONTROL 051534

Suits RV Media 24" TV - 051263



RV MEDIA VESA 200 X 100 CONVERSION KIT 043042

To suit RV Media TV Brackets.



RV MEDIA 240V POWER ADAPTOR 042388

To suit RV Media Series 1 and 2 19"/22"/24 TV's.

- Does not include 240V lead



12V TV LEAD ALL MODELS 19-24 044575

Suits all RV Media 19"-24" + 32" TV's.



RV MEDIA STAND & PLUG PACK 19IN 044571

Includes a 240V plug pack power supply and desktop stand to suit Evolution 19" TV's only
Suits o/s TV.



RV MEDIA STAND & POWER PACK 22/24 044572

Includes a 240V plugpack and desktop stand to suit 22" & 24" Evolution TV's only. Not smart TVs.
Suits o/s TV.



RV MEDIA STAND & PLUGPACK 19IN 051702

Includes a 240V plugpack power supply and desktop stand to suit Evolution 19" TV's only. Refer to manual on accessory part order.



RV MEDIA BACKLIT REMOTE CTRL 051702

Suits RV Media 24" & 32" TV - 051263, 051220 & 044694.

TELEVISION MOUNTING BRACKETS



LCD TV MOUNT SINGLE ARM

040154

SPECIFICATIONS

- Single arm with tilt for better viewing angles
- Folds back, extends out, good for corners
- Easy slide on installation
- Compatible with all major TV brands
- Fits TV's from 33-58cm (13-23")
- 15kg maximum weight



RV MEDIA LCD TV MOUNTS

042162 1 ARM

042163 2 ARM

042164 3 ARM

Designed specifically for the RV Industry, RV Media by Camec TV Brackets features the ultimate combination of functions ideal for all RV requirements.

FEATURES

- Bracket is removable from the mounting base (to allow the bracket to be used on another mounting base in or outside the RV)
- Bracket head is removable to allow easy stowage of the TV when the vehicle is in transit
- Easy locking system to lock the bracket against the wall when the vehicle is in transit
- Mounting base includes a spirit level for quick and easy installation
- Easy cable management system using removable plastic clips on the arms



SPECIFICATIONS

- Thumb screws are supplied to allow easy removal of the mounting bracket or head without the need for special tools
- VESA 100 x 100 mounting points
- Adjustable head by up to 14° in all directions
- All brackets rated at 15kg load strength
- A BONUS second mounting base is supplied in the kit to allow an easy and cost effective addition of a second bracket mounting point

ANTENNAS



JACK OUTDOOR DTV ANTENNA

044396

Your way to receive free crystal clear digital high definition television. Can also be used as a replacement for the Wineguard Sensor "Batwing" Antenna.

FEATURES

- Built in amplifier for maximum VHF and UHF reception
- Universal bracket for pole mounting
- Perfect antenna for caravans, RV's and residential use

SPECIFICATIONS

- Antenna head: 415mm(w) x 318mm(d) x 55mm(h)
- Frequency bands: VHF (47-230Mhz) - 20dB gain UHF (470- 860Mhz) -25dB gain
- Power Supply: Input 240v ~50Hz

KIT CONTAINS

- Jack antenna head
- Pole mount bracket
- Power supply
- Power injector
- RV antenna bracket



JACK ROOF MT ANTENNA

044397 WHITE PACK OF 5

044398 BLACK PACK OF 5

Now even more affordable with stylish updated cosmetics! Simple easy to use directional antenna solution that does not need cranking up or down and requires much less roof space than other RV antennas. Does not include inbuilt signal meter. Rotate the antenna head from inside the RV!

SPECIFICATIONS

- Dimensions: 226mm(h) x 406mm(w) x 305mm(l)
- Weight: 1.19kg
- Roof Thickness: 25-203mm
- Frequency Bands: VHF (54-216 Mhz), UHF (470-698 Mhz)
- Power requirements: 12V DC / 100mA



HAPPY WANDERER-POP TOP ANTENNA

002287

Simple to erect and stow. Tunes to horizontal and vertical polarised signals and can pick up UHF/VHF TV, FM radio and digital signals.

FEATURES

- Includes hook-on bracket



FOLDAWAY TALLBOY ANTENNA

002277

Suitable for use on vans, pop tops and wind-up campervans, A-vans and camper trailers.

FEATURES

- Lightweight and compact
- Folds up quickly to fit in the supplied carry tube
- Includes cable and brackets ready to mount

SPECIFICATIONS

- Tall boy antenna gives another 500mm height, extending standard antenna a total of 2 meters
- Can be set at various angles
- Cable ends with co-axial fitting
- Approx 7m cable fitted



FOLDAWAY STANDARD ANTENNA

002278

Suitable for standard caravans. Folds into its own carry tube when not in use.

FEATURES

- 360° of tuning either vertically or horizontally - can even be placed in an inverted "V" configuration
- Compact and ready to plug in
- Includes cable and bracket for outside mounting
- Digital compatible

SPECIFICATIONS

- Dimensions: 600mm(l) x 90mm(diam) when stored
- Weight: 1.5kg
- Suits caravans/pop top caravans, smaller camper buses and more.

ANTENNA ACCESSORIES & SPARES



FOLDAWAY ANTENNA EXTENSION ARM

002280

To suit Foldaway Antennas (refer codes 002277 and 002278).

FEATURES

- Extends the mast by one section around 500mm

SPECIFICATIONS

- Plastic



FOLDAWAY ANTENNA MOUNTING BRACKET

002281

Replacement bracket for Foldaway Antennas (refer codes 002277 and 002278).

FEATURES

- Foldaway Antenna bottom bracket



FOLDAWAY ANTENNA UPPER MOUNT CLIP

002282

Replacement upper mount clip for Foldaway Antennas (refer codes 002277 and 002278).



FOLDAWAY 35DB ANTENNA AMP

044745 - 12V

002285 - 240V

For campers to improve the TV signal in fringe or low signal areas.

SPECIFICATIONS

- Satking 35 decibel amplifier
- TV cable



EXPLORER PLATE FLYLEAD AND CONNECTOR PASSIVE

002344

Ideal for satellite or Foxtel or any brand of antenna.

FEATURES

- Comes with fitting for existing antenna cable and weather boot
- Thru-the-Wall passive connection kit and low loss fly lead
- A bonus PAL to female adaptor is included



EXPLORER POWER SUPPLY

002345

Power supply for explorer antenna system. C2 C3 C10 or C3sg, in fact any genuine Explorer system.

SPECIFICATIONS

- Dimensions: 50mm x 60mm + lead
- Weight: 20gm
- Power: 12V DC



EXPLORER 3M FLY LEAD TO SUIT ANTENNA KIT

002350

For that extra distance between the antenna socket and where you want to view the TV.

SPECIFICATIONS

- PAL Male to F Male



EXPLORER SIDE MOUNT BRACKETS

002372

Side mounts to suit 32mm aluminium, wood or conduit masts. Ideal for all types of caravans, boats, horse trucks, etc.

FEATURES

- Includes stainless steel fittings

SPECIFICATIONS

- Pack of 2



EXPLORER WALL CONNECTOR 19-32MM SPACE THROUGH WALL

002374

Suits cavity or wall thickness of 22mm to 37mm. Designed for Explorer boosted antennas only.

FEATURES

- Requires PS-P power supply
- Power injector is built onto plate
- If you have a 12V non-explorer system, can be used to tidy up your cables and connections



EXPLORER PASSIVE THROUGH CONNECTOR PC6A

002378

Connection upgrade to a "PASSIVE" kit - for use with any antenna. These connections will improve performance for TV and satellite signals in the 120Mhz to 840Mhz range.

EXPLORER THIN WALL THRU CONNECTION

043889

Thru the wall connection Kit for thin walls - less than 3 mm. Campervan Thru the wall Fitting for an external antenna point Fitting is ideal for fiberglass or Thin walls such a motor vehicle outer skin. A bulkhead fitting for a wall thickness of less than 3 mm. No special tools needed.

Use the fitting to bring the antenna signal in through the outer wall and into the vehicle and seal with the rubber and stainless washer - which can accommodate even a slightly curved wall without leaking.

Connect the cable and run to a viewing point. See our range of options for cable and connectors and internal fittings to complete your TV antenna cabling and connection!

This is a useful fitting for vehicles such as Combi Vans, HiAce camper trailers or vehicles with a fiberglass shell or at a bulkhead.

SPECIFICATIONS

- Wall thickness up to 3mm
- Stainless steel external fittings
- Black UV stabilised Silicon rubber cable weather protection boot
- Rated frequency range: 45 MHz - 3 GHz



JACK SPARES

- 042068 POWER INJECTOR - SPLITTER
- 042069 POWER SUPPLY 240V-12DVDC
- 042070 SURELOCK W/HOUSING
- 042071 CABLE RG174 M TO M15"



- 042072 CABLE RG174 M TO M21"
- 040863 JACK 12V INJECTOR SOCKET
- 044812 JACK COAX RG174 F TO F 20IN



CAMLOCK TELESCOPIC MAST ALUMINIUM - 25MM

035132

Aluminium Camlock action. Lightweight and compact.

SPECIFICATIONS

- Diameter: 25mm
- Extends from 1.83m to 3.65m
- Telescopic 2 section aluminium mast



CAMLOCK TV MAST ALUMINIUM - 32MM

002356

Aluminium Camlock action. Lightweight and compact.

SPECIFICATIONS

- Diameter: 32mm
- Extends from 1.83m to 3.65m
- Telescopic 2 section aluminium mast



CAMLOCK TV/POOL POLE ALUMINIUM - 32MM

002363

Aluminium Camlock action. Lightweight and compact.

SPECIFICATIONS

- Diameter: 32mm
- Extends from 2.44m to 4.8m
- Telescopic 2 section aluminium mast



CAMLOCK TV/POOL POLE ALUMINIUM - 25MM

002357

Aluminium Camlock action. Lightweight and compact.

SPECIFICATIONS

- Diameter: 25mm
- Extends from 1.83m to 3.65m
- Telescopic 2 section aluminium mast



SIDE MOUNT KIT AND 2 PIECE, 2.8M MAST

002370

To suit Explorer Antenna. Side mounts are recommended when access to the drawbar is restricted.

FEATURES

- Includes 2.8m 2 piece aluminium mast which collapses to 1.5m
- Includes plastic side mounts and stainless steel fittings



EXPLORER STANDARD DRAW BAR MOUNT

002361

Heavy duty, galvanised, suits "standard" draw bar (4in/100mm).

FEATURES

- Suits up to 40mm mast and 100mm draw bar



JACK ANTENNA MOUNT PLATE

044787

FOR PRE 2018 MODELS TO CURRENT

Mounting plate covers existing holes to create a water-tight seal on the RV roof. Pre-drilled for easy installation. Manufactured with a weather-resistant, automotive-grade plastic UV-protection ensures durability.



SURELOCK ANTENNA SIGNAL METER SL1000

040286

SureLock is a digital TV signal meter that enables you to pinpoint the location of television towers prior to scanning for television channels.



A-FRAME MOUNT FOR TV MAST

042664

Universal "A" frame clamp to fix antenna mast to caravan "A Frame".

SPECIFICATIONS

- Bracket Dimensions: 40mm diameter, A frame can be 110mm high and 50mm wide



TV FLY LEAD F TO TV 1.8M

040843

Connects between an RV wall plate with a female F type connector to the back of the TV.

- White
- 1.8m



ADAPTOR - MALE F TO MALE PAL

040845

To plug in back of TV (PA32U).



COAXIAL 1.8M FLY LEAD

040842

Suits TV/antenna Installation.

SPECIFICATIONS

- Female to female connector
- 'F' type fittings



COAXIAL 1.8M LEAD DOUBLE ENDED (HOME STYLE) TV LEAD

002339

PAL Male - PAL Male



COAXIAL 4.5M LEAD (HOME STYLE LEAD)

035134

FEATURES

- Includes male to female adaptor

SPECIFICATIONS

- Male to male connector



COAXIAL ADAPTER (FOR USA ANTENNA)

002387

To suit USA Wall Plate - female connector to standard TV lead.

SPECIFICATIONS

- Video adaptor "F" socket to PAL plug



COAXIAL PLUG MALE CHROME STEEL

002384

Coaxial male TV plug.

SPECIFICATIONS

- No crimp tool required



THRU THE WALL DIRECT CONNECT TO SUIT COAXIAL CABLE

034974

Connects antenna directly to the TV to avoid breaks in the connection.



COAXIAL THROUGH THE WALL KIT

002382

FEATURES

- Works on existing antenna and is ready for digital and satellite
- Quick and easy do-it-yourself kit
- Adjustable to suit various wall thickness
- Rubber weather protection cap to keep out moisture



COAXIAL DEEP TV SOCKET WHITE

002394



COAXIAL TV CABLE 75OHM 1M

002336

Low loss cable 75OHM.

SPECIFICATIONS

- No connectors fitted
- Sold as 100m lengths



COAXIAL ANGLE SOCKET

002389

SPECIFICATIONS

- 75 OHM surface mount
- White



COAXIAL MECHANISM

002392

SPECIFICATIONS

- 75 OHM plate mount
- White

SPEAKERS



RV MEDIA 100W 5" DUAL CONE RV VALUE SPEAKERS

041369 WHITE

FEATURES

- Stylish budget speakers
- One piece easy install design
- Dual cone 100W rated
- 30.1mm mounting depth
- Lighter than metal "one piece" speakers
- Screw covers supplied
- Wiring included

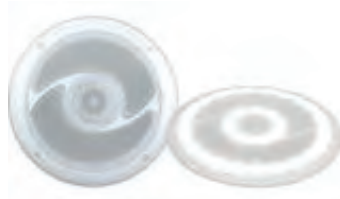

RM MEDIA 180W 6" 2-WAY LED SPEAKER WITH LIGHTS

041371 WHITE

FEATURES

- Combined speaker and integrated LED interior light
- Saves on roof space and installation time
- Features 33 cool white LEDs (per speaker) with an operating voltage of 10-28V
- 180W 2-way speaker with custom "swirl" grille and one-piece easy install design
- 34.2mm mounting depth



RV MEDIA 200W 6" WATERPROOF LED 2-WAY RV AND OUTDOOR SPEAKERS

041850 WHITE

042491 BLACK/CHROME

FEATURES

- 200W 2-way speaker with custom bridge tweeter
- 30 cool white super bright LEDs (per speaker)
- Ideal for RV, marine and home
- Includes rubber screw covers for a neat install
- Supplied with spacers to reduce mounting depth from 36.5mm to 22mm



RV MEDIA SPEAKER SPACERS WHITE

042623

Spacer to angle the RV-Media Waterproof speaker.

SPECIFICATIONS

- Pack of 2
- White
- Suit RV Media

RV MEDIA QUICK FIT FULLY WATERPROOF EXTERNAL 100W 2 WAY SPEAKERS

044144

Suitable for mounting on profiled aluminium or flat panel walls, these Australian designed 100W 2-way speakers do not require a cutout to be mounted yet offer superb sound quality. Simply fit the custom mounting base then push and turn to mount the speaker!

Supplied complete with universal foam sealing rings.

FEATURES

- Perfect for flat panel RV walls as the rear of the speaker will not protrude in to cupboard areas and reduce storage space PLUS they will not cause internal vibrations in storage spaces
- They are great for campers too where there are no wall cavities available!

SPECIFICATIONS

- Speaker height: 54.3mm
- Speaker diameter: 166mm
- Frequency response: 52-20kHz
- Power: 100W
- Nominal impedance: 40HM
- Neodymium tweeter magnet
- Polypropylene speaker cone
- IP65 Rated

AUDIO ACCESSORIES



RV MEDIA BLACK PVC AM/FM ANTENNA

042493

Black PVC antenna ideal for RV rooftop mounting.

SPECIFICATIONS

- Adjustable angle head
- Extra long 1500mm cable
- 3 year warranty



RV MEDIA PILLAR MOUNT AM/FM ANTENNA

041373

Stainless steel pillar antenna ideal for RV side mounting.

SPECIFICATIONS

- Complete with mid mount support and mounting screws
- Extra long 1500mm cable
- 3 year warranty



RV MEDIA WHITE PVC AM/FM ANTENNA

041374

White PVC antenna ideal for RV rooftop mounting.

SPECIFICATIONS

- Adjustable angle head
- Extra long 1500mm cable
- 3 year warranty



We are Italian



We are Italian, we love the Sweet Life

We love to travel, the great outdoors, cycling with our family and enjoy the pleasure of good food with our friends. Where we go we feel at home, just park up. Discover the best products for your vehicle!

F45S, the modern and compact wall installation awning
Suitable for all vehicles, it is a smart solution that combines functionality and minimalist look for contemporary travellers.





AWNINGS

Awnings.....	33
Annexes.....	38
Awning Accessories.....	40
Awning Spare Parts.....	43
Privacy Screens.....	52
Flooring.....	52
Covers.....	53

AWNINGS

FIAMMA CARAVANSTORE BAG AWNING

- A lightweight bag awning with a manual rollout operation. Specifically made for caravans and minivans, the Caravanstore Awning has an extra wide roller tube which can be rewound without the fabric wrinkling. It takes seconds to roll out and since the legs are inside the roller tube, they too are quick and easy to position.
- The legs are hinged and telescopic so they can't fall out and get lost. The design of the Caravanstore Awning has been improved recently and now comes with a central rafter fixing kit to ensure a centre rafter (not included) is installed safely (from Caravanstore 255). The lead bar now also features a second track so that a sunscreen or LED lights can be fitted.

FEATURES

- UV resistant, waterproof and rot proof vinyl
- Soft vinyl bag with self lubricating zipper
- Easy installation
- Royal grey fabric colour
- Fits into a standard rope track (not included)

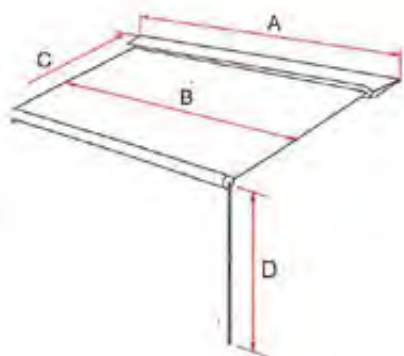
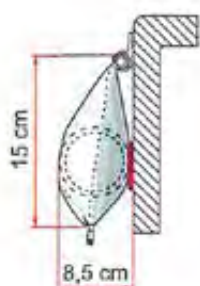

PART NO.	DESCRIPTION	WEIGHT	LENGTH (A)	LENGTH (B)	EXTENSION (C)	HEIGHT FROM GROUND (D)	SHADE SURFACE
044283	CSTORE 190	6KG	193CM	162CM	180CM	195CM	2.9M ²
044284	CSTORE 225	7.5KG	235CM	202CM	225CM	225CM	4.5M ²
044285	CSTORE 255	8.4KG	264CM	232CM	225CM	225CM	5.2M ²
051256	CSTORE XL 280	10.1KG	286CM	254CM	250CM	225CM	6.4M ²
044792	CSTORE XL 310	11.2KG	316CM	284CM	250CM	225CM	7.1M ²
044954	CSTORE XL 360	12.3KG	366CM	334CM	250CM	225CM	8.4M ²

FIAMMA F35 PRO AWNING

Perfect for your minivan, 4x4 or even a station wagon. Housed in a light anodized aluminium case, the Fiamma F35Pro has a manual mechanism - press the red button on the side of the casing to open, then walk backwards while unrolling the awning. The drop down legs are housed inside the roller tube.

VEHICLE

Designed for caravans and camper vans.

OPERATION

Manual opening and closing.



POSITION

Designed for wall installation. Adapters are available for wall or roof bars.

COLOURS & MATERIALS

- Super lightweight anodized aluminium case: Titanium
- Multi-layer canopy, in ultra-resistant waterproof and rot-proof vinyl, cool and cheerful, with bright colours on both sides.
- Colour: Royal Grey or Royal Blue



PART NO.		DESCRIPTION
036736		FIAMMA RAIL 4M FOR F35
001224		FIAMMA F35 RAIL 3.0M



PART NO.	CASE FINISHES	FABRIC COLOURS	LENGTH (A)	LENGTH (B)	EXTENSION (C)	MAX HEIGHT FROM GROUND (D)	SHADE SURFACE	WEIGHT
044290	TITANIUM	GREY	183CM	162CM	180CM	195CM	2.9M ²	8.5KG
051236	TITANIUM	BLUE	223CM	202CM	225CM	225CM	4.5M ²	10.5KG
044291	TITANIUM	GREY	253CM	232CM	225CM	225CM	5.2M ²	11.5KG
044292	TITANIUM	BLUE	303CM	282CM	225CM	225CM	6.4M ²	6.4KG

FIAMMA F45 L AWNING

This is a larger awning with extra large roller tube, perfect for motorhomes. With a winch opening and closing, operating by handle, this awning is designed for wall installation. It comes with reinforced leg knuckle, arms preset for LEDs.

FEATURES

- Double guide on the lead bar allowing installation of front panels
- Fast and silent opening and closing thanks to the Auto-Lock safety system and perfect closing thanks to Dual Security device
- Adjusting system that enables you to gauge the closing of the lead bar to guarantee a perfect closing over time
- Patented shock absorbing bracket with dual bolt system to protect the awning and the vehicle during bad weather
- Polar white casing



PART NO.	FABRIC COLOUR	LENGTH (A)	LENGTH (B)	EXTENSION (C)	SHADE SURFACE	WEIGHT
044303	GREY	502CM	485CM	250CM	12M ²	42.5KG
044304	BLUE	502CM	485CM	250CM	12M ²	42.5KG
044305	GREY	552CM	535CM	250CM	13.3M ²	46.5KG
044725	BLUE	552CM	535CM	250CM	13.3M ²	46.5KG

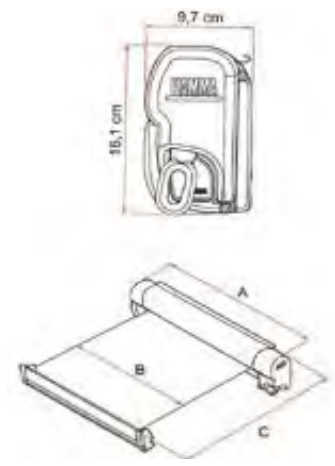

FIAMMA F45 S AWNING

Up-to-date model of the F45 awning. The renewed design is more compact and more functional with a lot of technical improvements. The lead bar has two tracks allowing for use as sunscreen or LED lights. Simple to use and easy to install on the wall of your RV. Sturdy and safe to operate with an easy to hook winch loop. Polar white or Titanium case.

FEATURES

- UV resistant, waterproof, washable
- Designed for wall installation and delivered with standard installation brackets
- Privacy room option available

** 1 tension rafter made of anodized aluminum included.

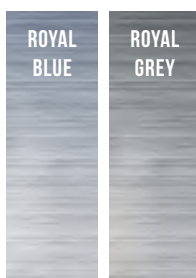
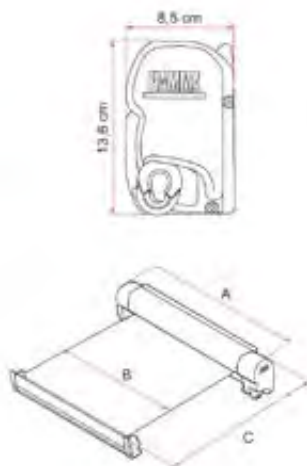

PART NO.	DESCRIPTION	CASING COLOUR	FABRIC COLOUR	AWNING LENGTH	CANOPY LENGTH	EXTENSION	SHADE SURFACE	WEIGHT
044415	FIAMMA F45 S AWNING 1.9M (LEGS NOT SUPPLIED)	POLAR WHITE	ROYAL GREY	1.85M	1.69M	1.00M	1.7M ²	11.5KG
051571	FIAMMA F45 S AWNING 2.3M	POLAR WHITE	ROYAL GREY	2.31M	2.14M	1.5M	3.2M ²	16.5KG
044293	FIAMMA F45 S AWNING 2.6M	POLAR WHITE	ROYAL GREY	2.63M	2.47M	2.00M	4.9M ²	19.5KG
044294	FIAMMA F45 S AWNING 2.6M	POLAR WHITE	ROYAL BLUE	2.63M	2.47M	2.00M	4.9M ²	19.5KG
044050	FIAMMA F45 S AWNING 2.6M	DEEP BLACK	ROYAL GREY	2.63M	2.47M	2.00M	4.9M ²	19.5KG
044306	FIAMMA F45 S AWNING 2.6M	TITANIUM	ROYAL GREY	2.63M	2.47M	2.00M	4.9M ²	19.5KG
044051	FIAMMA F45 S AWNING 3.0M	DEEP BLACK	ROYAL GREY	3.08M	2.92M	2.50M	7.3M ²	23KG
044295	FIAMMA F45 S AWNING 3.0M	POLAR WHITE	ROYAL GREY	3.08M	2.92M	2.50M	7.3M ²	23KG
044296	FIAMMA F45 S AWNING 3.0M	POLAR WHITE	ROYAL BLUE	3.08M	2.92M	2.50M	7.3M ²	23KG
044052	FIAMMA F45 S AWNING 3.5M	DEEP BLACK	ROYAL GREY	3.48M	3.31M	2.50M	8.3M ²	25KG
044297	FIAMMA F45 S AWNING 3.5M	POLAR WHITE	ROYAL GREY	3.48M	3.31M	2.50M	8.3M ²	25KG
044298	FIAMMA F45 S AWNING 3.5M	POLAR WHITE	ROYAL BLUE	3.48M	3.31M	2.50M	8.3M ²	25KG
040144	FIAMMA F45 S AWNING 3.5M	POLAR WHITE	BORDEAUX	3.48M	3.31M	2.50M	8.3M ²	25KG
044299	FIAMMA F45 S AWNING 4.0M**	POLAR WHITE	ROYAL GREY	3.98M	3.81M	2.50M	9.5M ²	27KG
044300	FIAMMA F45 S AWNING 4.0M**	POLAR WHITE	ROYAL BLUE	3.98M	3.81M	2.50M	9.5M ²	27KG
044307	FIAMMA F45 S AWNING 4.0M**	TITANIUM	ROYAL GREY	3.98M	3.81M	2.50M	9.5M ²	27KG
044569	FIAMMA F45 S AWNING 4.0M**	DEEP BLACK	ROYAL GREY	3.98M	3.81M	2.50M	9.5M ²	27KG
051444	FIAMMA F45 S AWNING 4.5M**	DEEP BLACK	ROYAL GREY	4.48M	4.31M	2.50M	10.8M ²	29.5KG
044301	FIAMMA F45 S AWNING 4.5M**	POLAR WHITE	ROYAL GREY	4.48M	4.31M	2.50M	10.8M ²	29.5KG
044302	FIAMMA F45 S AWNING 4.5M**	POLAR WHITE	ROYAL BLUE	4.48M	4.31M	2.50M	10.8M ²	29.5KG

FIAMMA F65 L AWNING

Design inherited from Fiamma roof awnings now makes the new F65L more compact and sturdy. The new reinforced cover box, available together with the new end caps as spare parts for the previous model, makes the new F65L modern and stylish, easy to be integrated with the shape of the latest vehicles. The lead bar is predisposed to accommodate LED lights for quick and easy installation.

VEHICLE
Perfect for motorhomes, caravans and van conversions.

OPERATION
Winch opening and closing. Operation by handle. Electric motor optional.

POSITION
Designed for roof installation. Adapters optional available.

AWNING ENCLOSURE
Optional Privacy Ultra-Light, Privacy Room, front and side panels Blocker & Side.

COLOURS & MATERIALS
Case: in extra strong extruded aluminium. Very light yet highly resistant external coating in either Polar White or Titanium. Cool and cheerful vinyl canopy. UV resistant, waterproof and washable, with bright colours on both sides.



PART NO.	DESCRIPTION	CASING COLOURS	FABRIC COLOURS	AWNING LENGTH A	CANOPY LENGTH B	EXTENSION C	SHADE SURFACE	WEIGHT
044790	FIAMMA F65 L AWNING 4M	TITANIUM	ROYAL GREY	4.0M	3.8M	2.5M	9.5M ²	36KG
050741	FIAMMA F65 L AWNING 4M	POLAR WHITE	ROYAL GREY	4.0M	3.8M	2.5M	9.5M ²	36KG
044726	FIAMMA F65 L AWNING 4.5M	POLAR WHITE	ROYAL GREY	4.5M	4.3M	2.5M	10.8M ²	41KG
050811	FIAMMA F65 L AWNING 4.9M	POLAR WHITE	ROYAL GREY	4.9M	4.7M	2.5M	11.8M ²	44.5KG

FIAMMA F80 S AWNING

An awning with an extremely small cross-section to integrate it even better in the contour of the vehicle.

The technical solutions which have been implemented mean a more compact awning protrusion. The introduced innovations, like dual prearrangement as standard equipment for LED lighting on the lead bar and on the case, in addition to three guides on the lead bar, make F80s the go-to solution for all roof-mounted installations.

- FEATURES**
- Brackets: more than 40 types of dedicated brackets available on request
 - Dual Shock-Absorber: absorbs shocks in case of heavy stress
 - Roller support: facilitates the rolling up of the fabric
 - Secure Lock: adjusts the height of the lead bar
 - Reinforced arms: keep the fabric tensioned
 - One Way Roll: guides the direction of rolling up
 - LEDs: double front LED arrangement + case box
 - Triple guide: allows the installation of two front panels and other accessories
 - Leg: telescopic and equipped with a reinforced joint



PART NO.	DESCRIPTION	CASING COLOURS	FABRIC COLOURS	AWNING LENGTH A	CANOPY LENGTH B	EXTENSION C	WEIGHT	SHADE SURFACE
051259	FIAMMA F80 S AWNING 2.9M	POLAR WHITE	ROYAL GREY	2.9M	2.78M	2.0M	27KG	5.6M ²
051262	FIAMMA F80S AWNING 2.9M	BLACK	ROYAL GREY	2.9M	2.78M	2.0M	27KG	5.6M ²
050999	FIAMMA F80 S AWNING 3.2M	POLAR WHITE	ROYAL BLUE	3.2M	3.08M	2.5M	29KG	7.7M ²
051132	FIAMMA F80 S AWNING 3.2M	POLAR WHITE	ROYAL GREY	3.2M	3.08M	2.5M	29KG	7.7M ²
051169	FIAMMA F80S AWNING 3.2M	BLACK	ROYAL GREY	3.2M	3.08M	2.5M	29KG	7.7M ²
051239	FIAMMA F80S AWNING 3.2M	TITANIUM	ROYAL GREY	3.2M	3.58M	2.5M	29KG	7.7M ²
051133	FIAMMA F80 S AWNING 3.4M	POLAR WHITE	ROYAL GREY	3.4M	3.28M	2.5M	30KG	8.2M ²
051167	FIAMMA F80 S AWNING 3.7M	POLAR WHITE	ROYAL GREY	3.7M	3.58M	2.5M	32KG	9.0M ²
051168	FIAMMA F80 S AWNING 3.7M	TITANIUM	ROYAL BLUE	3.7M	3.58M	2.5M	32KG	9.0M ²
051108	FIAMMA F80S AWNING 3.7M	TITANIUM	ROYAL GREY	3.7M	3.58M	2.5M	32KG	9.0M ²
051170	FIAMMA F80S AWNING 3.7M	BLACK	ROYAL GREY	3.7M	3.58M	2.5M	32KG	9.0M ²
051171	FIAMMA F80S AWNING 4.0M	BLACK	ROYAL GREY	4.0M	3.88M	2.5M	34KG	9.7M ²
051176	FIAMMA F80 S AWNING 4.0M	POLAR WHITE	ROYAL GREY	4.0M	3.88M	2.5M	34KG	9.7M ²
051307	FIAMMA F80S AWNING 4.5M	POLAR WHITE	ROYAL GREY	4.5M	4.31M	2.5M	36.5KG	10.8M ²

FIAMMA F65 EAGLE AWNING 400

In order to grant maximum comfort and complete safety the new 12V electric awning can easily be opened by using the rocker switch inserted into the wall of the vehicle. Delivered as standard with Wind Detection System: wind sensor that automatically activates the 12V motor and closes the awning in case of strong wind, avoiding possible damage.

The motor kit also allows manual closing in case of emergency.

The self-supporting arms are reinforced thanks to the sturdy duralumin Double Block that doesn't require the use of support legs.

The angle of inclination of the arms is prefixed at 10 degrees, but can be changed according to the height of motorhome from 5° to 17°, enabling the correct flow of water.

FEATURES

- Brackets: Not included. Optional for standard version (400 cm)
- Presto Fix: guarantees perfect closure of the lead bar over time
- Roller support: facilitates the rolling up of the fabric
- Motor: equipped with 12 V motor
- Reinforced arms: keep the fabric tensioned
- One Way Roll: guides the direction of rolling up
- Double guide: allows the installation of two front panels and other accessories
- Wind Detection System: sensor that is automatically activated and closes the awning in case of strong wind
- LEDs: the cable ducts on the arms allow the passage of cables for the optional Fiamma LED kits
- Double Block support: allows the regulation of the inclination from 5° to 17° and reinforces the self-supporting arms, thus avoiding the use of support legs



PART NO.	DESCRIPTION	CASE COLOURS	FABRIC COLOURS	AWNING LENGTH A	CANOPY LENGTH B	EXTENSION C	SHADE SURFACE	WEIGHT
051195	FIAMMA F65 EAGLE AWNING 400	POLAR WHITE	ROYAL GREY	4.2M	3.8M	2.5M	9.5M ²	37.5KG

* The vehicle must be robust enough to support the weight and the tension of the open awning.

FIAMMA F40 VAN 270

F40van is a roof-mounting awning designed specifically for camper vans. Thanks to its reduced size and integrated brackets, it is the perfect complement to the vehicle. Designed with attention to detail, with automotive style finishings. It unrolls in an overhand motion to guarantee fabric tension.

FEATURES

- Brackets: wide range of brackets that can be purchased separately
- Reinforced arms: with reduced section
- One Way Roll: guides the direction of rolling up
- One guide: allows the installation of front panels and accessories
- Flat legs: with predefined position for fast and precise opening
- Does not include mounting brackets



PART NO.	DESCRIPTION	CASE COLOURS	FABRIC COLOURS	AWNING LENGTH A	CANOPY LENGTH B	EXTENSION C	SHADE SURFACE	WEIGHT
051188	FIAMMA F40 VAN 270	DEEP BLACK	ROYAL GREY	2.7M	2.57M	2.25M	5.8M ²	19KG



ANNEXES

FIAMMA PRIVACY ROOM

Double your outdoor living space with one of Fiamma's Privacy Rooms. Suitable for use on F45S and F65/F80 and F45L awnings, they transform your awning into a comfortable living space. The front panel is inserted into the track of the lead bar, and is joined to the side panels by zippers. Includes 1 front panel with door and window (with mosquito nets), 2 side panels with windows (with mosquito nets), 1 fast clip system, support poles, curtains for all windows and a mega bag for storage.

SPECIFICATIONS

- The side panels are quickly put together with the fast clip that combines the canopy with the side walls
- Guaranteed close fit
- The front panel is inserted in the front rail of the awning and joined to the side panels with zippers



PART NO.	DESCRIPTION	AWNING LENGTH (A)	HEIGHT FROM GROUND (B)	EXTENSION (C)	WEIGHT
051390	FIAMMA PRIVACY ROOM 300 MEDIUM - F45	3.0M	2.25-2.50M	2.50M	24.4KG
051389	FIAMMA PRIVACY ROOM 300 LARGE - F45	3.0M	2.51-2.80M	2.50M	24.7KG
044344	FIAMMA PRIVACY ROOM 350 MEDIUM	3.5M	2.25-2.50M	2.50M	24.9KG
044345	FIAMMA PRIVACY ROOM 400 MEDIUM	4.0M	2.25-2.50M	2.50M	25.4KG
044346	FIAMMA PRIVACY ROOM 300 LARGE	3.0M	2.51-2.80M	2.50M	24.7KG
044347	FIAMMA PRIVACY ROOM 350 LARGE	3.5M	2.51-2.80M	2.50M	25.2KG
044348	FIAMMA PRIVACY ROOM 400 LARGE	4.0M	2.51-2.80M	2.50M	25.7KG
051107	FIAMMA PRIVACY ROOM 450 LARGE	4.5M	2.51-2.80M	2.50M	26KG
044350	FIAMMA PRIVACY ROOM 500 LARGE	5.0M	2.51-2.80M	2.50M	26.7KG
044351	FIAMMA PRIVACY ROOM VAN 260 FITS VW				

FIAMMA FRONT PANEL

Made of translucent light filtering fabric, which partially blocks out light. It can be rolled up with convenient fixing clips. Supplied with ropes and pegs for fastening.

PART NO.	DESCRIPTION
051393	FIAMMA FRONT PANEL 100 F45/F65/F80
051394	FIAMMA FRONT PANEL 150 F45/F65/F80
051392	FIAMMA FRONT PANEL 200 F45
051391	FIAMMA FRONT PANEL 50 F45



SPARE PARTS

PART NO.	DESCRIPTION
044342	FIAMMA PRIVACY ROOM PANEL 80
051395	FIAMMA PRIVACY ROOM F45
051191	FIAMMA ROOM VAN PREMIUM
041501	FIAMMA PRIVACY ROOM PANEL L/H
051192	FIAMMA MEGA BAG LIGHT

PRIVACY ROOM F45



PART NO.	BASIC MODULE
051395	(S) ROOM VAN 260 VAN
051390	(M) ROOM 300 - MEDIUM
051389	(L) ROOM 300 - LARGE

PART NO.	FRONT PANELS
051491	(G) VAN 40CM
051391	(I) 50CM
051493	(O) 75CM
051393	(P) 100CM
051494	(Q) 125CM
051394	(U) 150CM
051392	(W) 200CM

DESCRIPTION	AWNING LENGTH	BASIC MODULE	COMPOSITION
PRIVACY ROOM VAN 260	260CM	VAN (S)	(S)
PRIVACY ROOM 300	300CM	180-220CM	(S) + G
P.ROOM 300 LARGE	300CM		(M)
P.ROOM 350 MEDIUM	350CM		(M) + I
P.ROOM 375 MEDIUM	375CM	MEDIUM (M)	(M) + O
P.ROOM 400 MEDIUM	400CM	225-250CM	(M) + P
P.ROOM 425 MEDIUM	425CM		(M) + O
P.ROOM 450 MEDIUM	450CM		(M) + U
P.ROOM 300 LARGE	300CM		(L)
P.ROOM 350 LARGE	350CM		(L) + I
P.ROOM 375 LARGE	375CM		(L) + O
P.ROOM 400 LARGE	400CM	LARGE (L)	(L) + P
P.ROOM 425 LARGE	425CM	251-280CM	(L) + Q
P.ROOM 450 LARGE	450CM		(L) + U
P.ROOM 500 LARGE	500CM		(L) + W
P.ROOM 550 LARGE	550CM		(L) + I + W

DESCRIPTION	AWNING LENGTH	BASIC MODULE	COMPOSITION
P.ROOM 300 / H: 245-280	300CM		(L)
P.ROOM 320 / H: 245-280	320CM		(L) + F
P.ROOM 340 / H: 245-280	340CM		(L) + H
P.ROOM 370 / H: 245-280	370CM	LARGE (L) 280CM	(L) + N
P.ROOM 400 / H: 245-280	400CM		(L) + P
P.ROOM 425 / H: 245-280	425CM		(L) + O
P.ROOM 450 / H: 245-280	450CM		(L) + U

AWNING ACCESSORIES



FIAMMA CLIP SYSTEM

040272

The Fiamma 'Clip System' guarantees a 100% water tight seal between the awning canopy fabric and the Privacy Room side walls; this is achieved using the Clip System. The Clip System is effectively a clamping system, with an upper and a lower section that clamp around the awning roof fabric. The Clip System also incorporates a 'C' channel, which allows the side panel to fit into, once this has been fitted the roof fabric clamping procedure begins.

The clip system includes two vertical poles for adjacent to the vehicle plus the two sets of the clamps to hold both side walls in place across the top. Made to suit the 2500mm wide awnings.

Can also be fitted to F65 & F80 Awnings with the use of additional Mounting Adaptors, see related products below.

SPECIFICATIONS

- Suits F45-s awnings, all sizes with a 2.5m extension
- Does not suit F45 2.6 awnings (they have a 2m extension)
- Also fits earlier models
- Will accept end walls with a standard rope spline like Coast & CGear



ALUMINIUM ACUTE CURVED ROOF RAIL

042312 - WHITE
051472 - BLACK

Acute curved.

SPECIFICATIONS

- 25mm square tube
- Extends to 2430mm



CURVED ROOF RAFTER WITH BRACKET

001616

Curved roof rafters are used to keep the vinyl roof from sagging, ensuring 100% water run-off, as well as keeping the fabric tight and reducing wind flap. Best results are achieved when used in conjunction with an anti-flap kit.



GRASSHOPPER ANTI FLAP KIT

050957

Grasshopper have created an anti flap kit to stop the annoying awning flap caused by wind or rain entering from the side walls. The innovative Anti-Flap Kit is designed to stop all of this and the damage it can cause. It's perfect for roll out awnings and has been created from the most durable and high quality products on the market, to ensure it's suited to helping you for years to come.

The Anti-Flap kit is incredibly compact and easily stored, thanks to the innovative design, which allows you to break it down into four individual sections. When joined together, they form a full-length straight roof rafter, which is used with specifically designed clamps to hold the canopy fabric and prevents it from flapping. The straight roof rafter also has two sail tracks designed into its profile, which perfectly enables it to hold two side walls, giving you more flexibility in wall choice at all times.

FEATURES

- Offers an obstacle free roof extension
- Helps hold the vinyl roof sturdy and when used in conjunction with annex/shades the Stop Flap Clips forms a wind proof connection
- Compact design allows for easy storage



ALUMINIUM SLIGHT CURVED ROOF RAIL

035227 SLIGHT CURVE WHITE
051471 SLIGHT CURVE BLACK

SPECIFICATIONS

- 25mm square tube
- Extends to 2430mm
- Supports the awning to stop water pooling and limit flap noise



GRASSHOPPER TENSION RAFTER

050959

The Straight Roof Tension Rafter has been especially developed to assist the Roll Out Awning, ROA, by stretching the Vinyl canopy at the middle of the Awning. This is achieved by the arm which puts pressure on the Roller, the Tension Arm is a pump action lever. As with the Straight Roof Rafter, this Tension Rafter has been developed with a Sail Track which can be used to hang a wall panel off.



ANTI FLAP CAM HANDLE & SPRING

042277

Suits Aussie traveller anti flap kit



AUSTRALITE ANNEX PROTECTOR

015628

Fits to leading edge of main door and protects annex/awning roof from damage.



FIAMMA AWNING TIE DOWN KIT

051693

Useful strap to hold the awning firmly anchored to the ground in light wind. It fits crank awnings up to 600cm in length.

Composed of:

- 1x adjustable band (11m), in black
- 2x stakes
- 1x tension spring.



ROPE TRACK SINGLE

- 001650 5.5M BRIGHT WHITE
- 042060 6.0M BLACK
- 042063 6.0M CLEAR ANODIZED
- 001646 6.5M BRIGHT WHITE

Single fixing, aluminum track for securing vertical or horizontal walls of annex.



ROPE TRACK DOUBLE

- 042064 6.0M CLEAR ANODIZED
- 042065 6.0M BLACK
- 001649 6.5M BRIGHT WHITE

Double fixing, aluminum track for securing vertical/horizontal walls of annex.



FIAMMA MAGIC RAFTER PRO

041941

Comes complete with two special brackets to fix in the knuckles of the arms in order to keep the fabric tensioned.

FEATURES

- Easy to install
- When not in use it takes up little space
- Limited usage at high temperatures
- For awnings from 350 to 450cm
- Helps limit water pooling and fabric flap



AWNING BRACKET

050035

Stainless Steel awning pole bracket to provide additional support to RV roll-out awnings.

The amount of support that RV awnings require is often underestimated resulting in one of the largest reasons for insurance claims in the RV industry. You can prevent this occurring on your RV in a very cost-effective way with the simple installation of our awning pole bracket.

FEATURES

- Suits Carefree, A&E & Dometic awnings.
- Not suitable for Fiamma awnings.

SPECIFICATIONS

- Sizes: 38 X 40mm
- 10mm dia slot for tent poles
- 8mm spline



STAINLESS STEEL CARAVAN AWNING ROPE CLIPS

050036

Stainless steel awning rope clip to suit most awnings. Sold as a pair. Any well-prepared camper and caravanner would know that it pays to have a plan in place in case of unexpected windy weather conditions blowing up during your holiday. Stainless steel awning rope clips provide the most reliable method of quickly improving awning stability and guaranteeing that it will withstand the wind.

FEATURES

- Manufactured from quality stainless steel, rust-resistant, and springs back into shape enabling long-term durability.
- Designed to fit Dometic (A&E), Carefree and Aussie traveller awnings.
- Sold as a pair.



CARAVAN AWNING SAFETY STRAPS

050037

Velcro caravan awning safety straps for securing awning arms.

Reduce the rattling and risk of your awnings and pole breaking whilst traveling. These straps are unbelievably handy for all RV owners when transporting awning hardware, and are great when used as replacement straps for Caravan De-Flappers (not the pop-top variety).

SPECIFICATIONS

- 50 (w) x 390mm (l)
- 160mm sections of hook and loop straps at each end.
- 2 straps per pack



GRASSHOPPER STORAGE BAG

050958

The travel bag keeps your anti flap kit in tip top condition. Most damage to your anti flap kit occurs during travel. Vibration during travel causes wearing of the powder coating or the polished aluminum metal surface, an anti flap kit storage system has four separate slots which keep each arm separated thus avoiding the usual wear and tear.

The protection system when rolled up can slot into a 150mm drainage pipe. Travelers usually locate such a tube at the rear of the caravan.

The storage bag, made from the tough Dacron, is held sturdy by Velcro straps sewn into the edge seam.

FIAMMA RAFTER PRO (CURVED)

001615

The Rafter Pro is made of two sturdy anodized aluminium telescopic bars. Ideal for awnings with extension up to 250cm, it is adjustable in length from 144 to 265cm. Limit usage at high temperatures as it may affect the fabric tension.



ANTI FLAP KIT BRACKET

050034

For Aussie Traveller anti-flap kit. Allows a support pole to be fitted.



KNURLED KNOB & T NUT AUS TRV

035090

Replacement knob for Aussie Traveller anti flap kit



F45 TENSION RAFTER (STRAIGHT)

001250

AWNING ACCESSORIES

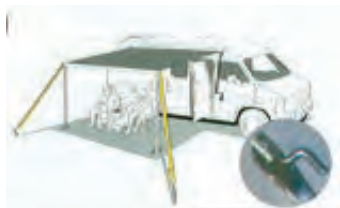

FIAMMA AWNING TIE DOWN KIT 001610

Anchors awning to the ground in windy conditions.

FEATURES

- Kit includes 11m of yellow adjustable strap, pegs and tension spring
- Fits awnings up to 6m in length
- Fits into the awning rails or the side clip of the privacy room



FIAMMA AWNING LED LIGHT KIT 038914

Composed of two strips of 9 LED lights, low consumption, 12V power supply cable 5m long. Easy joint installation by simple pressure on the front bar. Also fits previous awning versions.

FEATURES

- 2 x 9 LED lamps and 12V cable
- Easy to install on front bar of most models of F45 and F65 awnings



HAPPY HOOK TIE DOWN KIT 001609

Attach Happy Hook to awning and screw stakes into the ground and adjust poly tie-down cords. Fully rotates to keep fabric taut without stretching or separating.

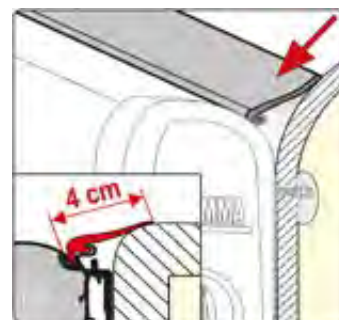

FIAMMA AWNING RUBBER SEAL STRIP 035272

For awnings, mounted with adapter spaced out from the wall (up to 4cm) or on curved walls.

Sold per metre



FIAMMA LEG BRACKET KIT - TITANIUM

035275



FIAMMA LEG BRACKET KIT - PLASTIC

001280

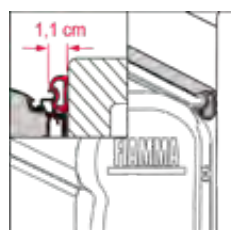

FIAMMA RAIN GUARD KIT S550

051286



F45 SIDE W PRO <4M

033783



WALL BRACKETS DEEP BLACK



051184



AWNING FABRIC REPAIR KIT

035274

FIAMMA F45 MOTORS

PART NO.	DESCRIPTION
041449	 F45 S 12 V MOTOR KIT WHITE
040700	 F45 L 12 MOTOR KIT WHITE
041519	 F45 S MOTOR KIT TITANIUM
051763	 FIAMMA F45S MOTOR KIT DEEP BLACK

FIAMMA F65/F65S/F80 MOTORS

PART NO.	DESCRIPTION
044826	F65S MOTOR KIT - LH END
041535	F65 MOTOR KIT TITANIUM
051255	F80S MOTOR KIT WHITE
051203	F80S MOTOR KIT COMPACT DEEP BLACK
051207	F80 MOTOR KIT PLUS TITANIUM
051711	FIAMMA F80S MOTOR KIT DEEP BLACK

FIAMMA F35 BRACKETS

PART NO.	DESCRIPTION
034091	F35 AUTO ADAPTOR KIT

FIAMMA F45 BRACKETS







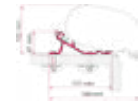
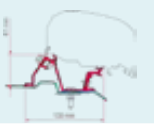

PART NO.	DESCRIPTION
038896	F45 ADAPTOR RENAULT
040950	F45 FIT KIT DUCATO 2006
043230	FIAMMA KIT SPRINTER H3
041386	F45 AS 400 ADAPTOR

FIAMMA F45 BRACKETS

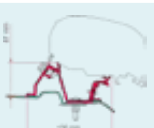
PART NO.	DESCRIPTION
001252	F45 STD AS 120 BRKT KIT
001253	F45 T5 BRACKET KIT
001254	F45 VAN BRKT KIT
001256	F45 T ADAPTER
001261	F45 T3 BRACKET KIT
001262	F45 T4 BRACKET KIT
001266	F45 U BRACKET
001293	F45 S 120 BRACKET KIT
034090	F45 AWNING WALL ADAPTOR KIT
034371	F45 S 400 BRACKET KIT
035278	F45 MULTI BRACKET KIT
038337	F45 SPRINTER/TRANSIT FIT KIT

AWNING SPARE PARTS

FIAMMA F65/F65S/F80 BRACKETS

PART NO.		DESCRIPTION
038927		F65 FIXING BAR KIT
044489		F65 ADAPTOR KIT STANDARD
042104		F65/80 MERCEDES SPRINTER KIT - VW CRAFTER (HIGH ROOF) RH
033855		F65/F80 FIT KIT DUCATO 2006
033835		F65/F80 FIT KIT MERC SP
001338		F65/F80 BRACKET KIT DUCATO
051240		F65/F80 MOUNTING BRACKET MERCEDES SPRINTER >06/2006
042104		F65/80 MERCEDES SPRINTER
001338		F65/F80 BRACKET KIT
051172		KIT VW CRAFTER WITHOUT ROOF RAIL (2020+)

FIAMMA CARAVAN STORE SPARE PARTS

PART NO.		DESCRIPTION
033572		C/STORE RH ARM SLEEVE
038278		C/STORE 05 LH KNUCKLE
038279		C/STORE 05 RH KNUCKLE
038428		C/STORE LEG INSERT
042600		C/STORE RAFTER FITS CARAVANSTORE
038379		C/STORE F35 LH KNUCKLE
051744		FIAMMA PEG/GUY KIT

FIAMMA F35 SPARE PARTS

PART NO.		DESCRIPTION
036736		FIAMMA RAIL 4M FOR F35
042303		PRIVACY ROOM ADAPTER KIT FOR F35
038379		FIAMMA F35 LH KNUCKLE
001224		FIAMMA F35 RAIL 3.0M

FIAMMA F35 SPARE PARTS

PART NO.	DESCRIPTION
026308	FIAMMA F35 PRO RAFTER ARM
042609	F35 RAFTER END PART FITS F34 PRO 220
043037	F35 PRO RAFTER FIX KIT
051742	FIAMMA F35 LEG CLAMP

FIAMMA F45 SPARE PARTS

PART NO.	DESCRIPTION
040208	LH LEG 2.5M
040209	RH LEG 2.5M
040210	LH LEG 3.0M
040211	RH LEG 3.0M
040212	LH LEG 3.5-4.5M
040213	RH LEG 3.5-4.5M
040214	LH EXTENSION ARM 2.5M

FIAMMA F45 SPARE PARTS

PART NO.	DESCRIPTION
040215	RH EXTENSION ARM 2.5M
040216	LH EXTENSION ARM 3-4.5M
040217	RH EXTENSION ARM 3-4.5M
040218	LH ROLLER GEAR
040219	SLEEVE LH END CAP
040220	LH END CAP
040221	RH WINDER END CAP
040222	RH INNER WIND HOUS
040223	LH CASE INNER BRACKET 250 - 400
040224	RH SHK INNER BRACKET 250 - 400
040225	LH SHK ABSORB 4.5M
040226	RH SHK ABSORB 4.5M

FIAMMA F45 SPARE PARTS



040306 LH LEG TOP PLUG



041416 FRONT AWNING PANEL SUIT 3.5M AWNING



040307 RH LEG TOP PLUG

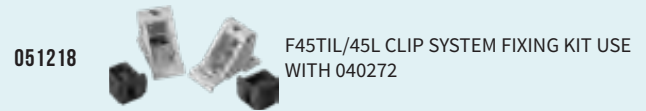

051218 F45TIL/45L CLIP SYSTEM FIXING KIT USE WITH 040272



040227 LH LEG KNUCKLE



001298 F45 LEG CLIP 2542



040228 RH LEG KNUCKLE

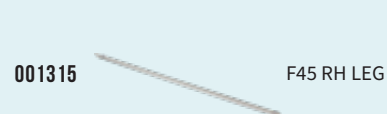

001315 F45 RH LEG



040229 LH KNUCKLE SHAFT

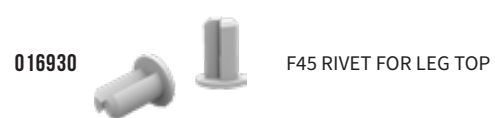

016930 F45 RIVET FOR LEG TOP



040230 RH KNUCKLE SHAFT



001272 F45 LH ARM SUPPORT JNT UP TO 4M



040231 LH FRONT END CAP



001273 F45 RH ARM SUPPORT JNT UP TO 4M



040232 RH FRONT END CAP

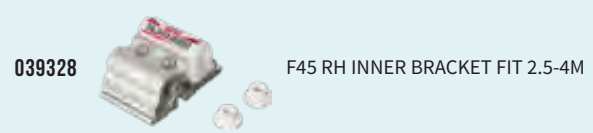

039328 F45 RH INNER BRACKET FIT 2.5-4M



040242 LH END CAP TITANIUM CASE



001295 F45 LH NYLON SHOCK INS



040243 RH WINDER END CAP TITANIUM CASE

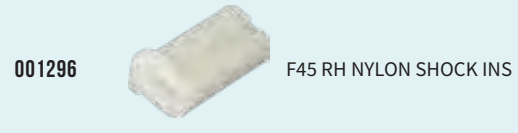

001296 F45 RH NYLON SHOCK INS

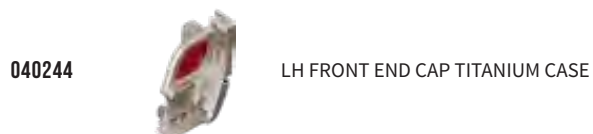

040244 LH FRONT END CAP TITANIUM CASE



035276 F45 PLUS WINCH 3.1





040245 RH FRONT END CAP TITANIUM CASE

FIAMMA F45 SPARE PARTS

026298  F45 XL-L LH END CAP

035279  F45I LH LOCK MECH 3M

001326  F45 RAPID SET ARMS SET

035960  F45I LH ARM AWN 3-4.5M

016934  F45I LH LEAD BAR CAP<4M

026297  F45 RH END CAP ASSY -

016935  F45I RH LEAD BAR CAP<4M

034631  F45I RH ARM AWNING >3M

001306  F45I RH END COVER <4.0M

001307  F45I LH END COVER UP TO 4M

001313  F45 SQ DRIVE ROLLER D/L

034304  F45I RAFTER FIXING BRKT

001311  F45I XL-L LH END CAP

001321  F45IL LH LEG 4.5-6M

001259  WINDER HANDLE WALL CLIP

001322  F45IL RH LEG 4.5-6M

051740  FIAMMA F45 S BRACKET

001309  F45IL LH ARM -4.5M+AWN

001320  F45I RH END CAP DELUXE

001310  F45IL RH ARM -4.5M+AWN

034086  F45I LH LEAD BAR CAP>4M

016928  F45L RH END CAP

001312  F45I RH LEAD BAR CAP>4M

001275  F45L LH ARM SUPPORT JNT

FIAMMA F45 SPARE PARTS

001276



F45L RH ARM SUPPORT JNT

039195



F45TIL RH LEG KNUCKLE

036730



F45TI RH END CAP >4M

039118



F45TI RH SHOCK COVER

036831



F45TI LH END CAP > 4M

040320



F45TIL LH ARM 4.5-5.5M

039222



F45TI LH END <4.0M

038819



F45TIL LEG TOP JNT SET 4.5 - 5.5M

036729



F45TI RH END <4.0M

001279



F45 WINDER COVER

026292



F45 LH END CAP COVER

034573



F45PLUS RH LEAD BAR CAP

039004



F45TI LH CAP POLAR WHT

026293



F45 PLUS LH CASE CAP

038327



F45TI RH LEAD BAR CAP

001274



F45I RH CASE CAP COMP

039196



F45TIL LH LEG FIX KIT

039327



F45 LH INNER BRKT FI

039197



F45TIL RH LEG FIX KIT

001258

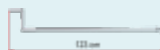

F45 WINDER HANDLE

039194



F45TIL LH LEG KNUCKLE

001263



F45 B LONG ROOF BRKT

051741



FIAMMA F45 S LEFT LEG END

016924



F45 RH DRIVE ROLLER

051743



WINCH MECHANISM FOR F45TIL

016929



F45 DRIVE ROLLER

FIAMMA F45 SPARE PARTS

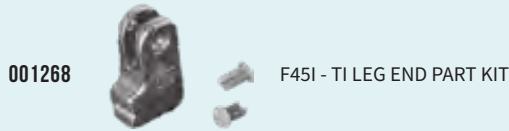

FIAMMA F50 SPARE PARTS

PART NO.		DESCRIPTION
001286		F50 PRO WINCH COVER

039012		F50 LH SIDE COVER
--------	--	-------------------

038377		F50, F55 CRANK HANDLE
--------	---	-----------------------

FIAMMA F65 / F65S / F80 SPARE PARTS

PART NO.		DESCRIPTION
041537		F65 LH LEAD BAR CAP TITANIUM

038234		F65 LH END COVER
--------	---	------------------

038378		F65 RH END CAP
--------	--	----------------

040248		F65 RH INNER END CAP TITANIUM CASE
--------	--	------------------------------------

040360		F65 S RH END CAP
--------	--	------------------

051669		F65L POLA LH END CAP
--------	--	----------------------

041031		F65 FIXING KIT FOR RAFTER
--------	--	---------------------------

043769		F65S/F65L FIXING KIT RH LEG
--------	--	-----------------------------

FIAMMA F65 / F65S / F80 SPARE PARTS

PART NO.		DESCRIPTION
043770		F65S/L LEG STOP PLATE
042420		F65/L INNER END CAP (LH)
042421		F65S 400 LEAD BAR GUIDE
042825		F65 LEFT END COVER TITANIUM
026311		F65L KNOB FOR LEG & RAFTER
042274		F65 S LEFT LEG FIXING KIT
051748		FIAMMA F65 TOP WINCH MECHANISM
051750		FIAMMA WINCH & SLOT MECHANISM 3.1 WHITE

F80 SPARE PARTS

PART NO.		DESCRIPTION
051674		F80 FAST CLIP ADAPTOR KIT
051751		F80S L/H WINCH END COVER POLAR WHITE
051752		F80S L/H WINCH END COVER POLAR WHITE
051753		F80S R/H WINCH END COVER POLAR WHITE
051754		F80S R/H WINCH END COVER DEEP BLACK
051755		F80S L/H END CAP POLAR WHITE
051756		FIAMMA F80S L/H LEG KNUCKLE
051757		FIAMMA F80S R/H LEG KNUCKLE
051758		F80S LEAD BAR END CAP DEEP BLACK L/H
051759		F80S LEAD BAR END CAP POLAR WHITE
051760		FIAMMA F80S LEAD BAR END CAP
051761		FIAMMA F80S LEG FOOT SUPPORT

F80 SPARE PARTS





051762  FIAMMA F80S LEG FOOT SUPPORT

051738  FIAMMA F80S L/H FIXING KIT

051739  FIAMMA F80S R/H FIXING KIT

051749  FIAMMA F80S L/H ARM FOR 320-450

FIAMMA SPARE PARTS

PART NO.	DESCRIPTION
051196	 FAST CLIP LEFT EXT 250RS
051197	 FAST CLIP RIGHT EXT 250RS
044355	 C/STORE 3101440 RIGHT RAFTER AND LEG
051200	 RIGHT SIDE PANEL PRIVACY ROOM LARGE
051378	 UPPER SECURITY COVER WHITE

PRIVACY SCREENS

CAMEC PRIVACY SCREEN

PART NO.	DESCRIPTION
050275	CAMEC PRIVACY END (CARAVAN) 2.1 X 1.8M WITH 2.05 ANGLE CUT
050274	CAMEC PRIVACY END (POP TOP) 2.1 X 1.8M
050265	CAMEC PRIVACY SCREEN 2.8 X 1.8M
050267	CAMEC PRIVACY SCREEN 3.1 X 1.8M
050268	CAMEC PRIVACY SCREEN 3.4 X 1.8M
050269	CAMEC PRIVACY SCREEN 3.7 X 1.8M
050270	CAMEC PRIVACY SCREEN 4.0 X 1.8M
050271	CAMEC PRIVACY SCREEN 4.3 X 1.8M
050272	CAMEC PRIVACY SCREEN 4.6 X 1.8M
050273	CAMEC PRIVACY SCREEN 4.9 X 1.8M

FEATURES

- 90% shade and UV block providing ultimate sun protection
- Stainless steel D-rings stitched to reinforced tabs across bottom edge for securing
- Feature a double rope track - 5mm and a 7mm spline to suit various awning styles
- Comes with privacy screen pegs and cords



PRIVACY SCREEN PEGS AND CORDS

044556

Set of 5 pegs and cords to tie down privacy screens.

FLOORING



CAMEC FLOOR MATTING

PART NO.	DESCRIPTION
044089	CAMEC FLOOR MATTING 3.0 X 2.5M
044090	CAMEC FLOOR MATTING 4.5 X 2.5M
044091	CAMEC FLOOR MATTING 5 X 2.5M
044092	CAMEC FLOOR MATTING 6 X 2.5M
044093	CAMEC FLOOR MATTING 7.0 X 2.5M

FEATURES

- Matting construction provides superior underfoot comfort
- Designed specifically to keep dirt, mud and sand from being walked into your caravan, RV or tent
- Great for picnics and any outdoor event
- Open mesh floor matting will not kill grass - preferred by all caravan parks
- Edges bounded by heavy duty webbing with brass eyelets for pegging down

C-GEAR MULTIMAT OUTDOOR CAMPING MAT

Sand and dirt fall straight through the mat to the ground beneath, not back up through the mat. Ideal for outdoor living areas and provides a sand and dirt free area for camping sites. It can be used as a shade mat (providing 90%+ UV protection) or as a windbreak for screening. Designed in Australia.



PART NO.	DESCRIPTION
038341	CGEAR MULTI MAT 1.8M X 2.4M
039256	CGEAR MULTI MAT 2.4M X 3.35M
038342	CGEAR MULTI MAT 2.4M X 4.3M
039616	CGEAR MULTI MAT 2.4M X 5.2M
038343	CGEAR MULTI MAT 2.4M X 6.0M
040022	CGEAR MULTI MAT 2.4M X 7.5M
039972	CGEAR MULTI MAT 3.05M X 3.05M
038344	CGEAR MULTI MAT 3.6M X 4.6M

FEATURES

- Sand and dirt fall readily through the mat
- Perfect for use under camp furniture
- UV stabilisers minimise degradation of mats from exposure to the sun
- Non-absorbent and will not rot or mould
- Liquid spills go through the mat
- Easy to wipe clean or hose down
- Environmentally friendly on the grass underneath, it doesn't kill grass
- May be used for shade or as a wind break
- Recyclable
- Lightweight and easy to set up and pack away
- Reinforced edges and multiple D-rings
- Durable and won't tear or fray, even if cut, due to rip stop technology
- Comes with a drawstring carry bag

COVERS



CAMEC PREMIUM RV COVERS

Camec Premium RV Covers have been designed and manufactured to protect your caravan from being exposed to harsh climatic conditions.

QUALITY

Specially manufactured using a composite of two materials comprising a water resistant roof section for maximum protection, weather resistant breathable side panels which allows the cover to breathe and moisture to evaporate resisting rot and mildew, ventilation flaps and a heavy duty reinforced skirt with an elasticised hem front and rear providing a strong guard against damage from sharp objects.

PROTECTION

The cover will provide excellent protection against acid rain, industrial pollutants, tree sap, bird droppings, dust and weather damage caused by leaving your caravan uncovered whilst exposed to the weather.

Sizes listed are body length (not including A Frame)

PRACTICALITY

Incorporated into the complete range of Camec Premium RV Covers which are lightweight and easy to fit are practical features such as nylon straps attached to both the front and rear plus four reinforced tabs with eyelets at both front and rear so that the cover can be made nice and taut ensuring it is securely fastened for all weather conditions.

FEATURES

- 300D water resistant UV 50+ roof section
- Water resistant breathable side panel
- Reinforced skirt with dual nylon clip
- Double stitched reinforced corners
- Ventilation flaps
- Soft non abrasive lining
- 3 year warranty

CAMEC CARAVAN COVER

PART NO.	DESCRIPTION	SIZE
044108	CAMEC CARAVAN COVER C16CCV	14 - 16' 4.3 - 4.8M
044109	CAMEC CARAVAN COVER C18CCV	16 - 18' 4.8 - 5.4M
044110	CAMEC CARAVAN COVER C20CCV	18 - 20' 5.4 - 6.0M
044111	CAMEC CARAVAN COVER C22CCV	20 - 22' 6.0 - 6.6M
044112	CAMEC CARAVAN COVER C24CCV	22 - 24' 6.6 - 7.3M
043030	CAMEC CARAVAN COVER C26CCV	24 - 26' 7.3 - 7.9M



CAMEC POP-TOP COVER

PART NO.	DESCRIPTION	SIZE
044113	CAMEC POP-TOP COVER C14PCV	12 - 14' 3.7 - 4.4M
044114	CAMEC POP-TOP COVER C16PCV	14 - 16' 4.3 - 4.8M
044115	CAMEC POP-TOP COVER C18PCV	16 - 18' 4.8 - 5.4M
044116	CAMEC POP-TOP COVER C20PCV	18 - 20' 5.4 - 6.0M



CAMEC CAMPER TRAILER COVER

PART NO.	DESCRIPTION	SIZE
044105	CAMEC CAMPER TR COVER C12CTCV	10 - 12' 3.0 - 3.7M
044106	CAMEC CAMPER TR COVER C14CTCV	12 - 14' 3.7 - 4.3M
044107	CAMEC CAMPER TR COVER C16CTCV	14 - 16' 4.3 - 4.8M

3 YEAR WARRANTY



MOTORHOME COVER

PART NO.	DESCRIPTION
051115	MOTORHOME COVER - 701 X 236 X 264CM
051116	MOTORHOME COVER - 792 X 236 X 264CM
051117	MOTORHOME COVER - 884 X 236 X 264CM

QUALITY

Specially manufactured using a composite of two materials comprising a water resistant roof section for maximum protection, weather resistant breathable side panels which allows the cover to breathe and moisture to evaporate resisting rot and mildew, ventilation flaps and a heavy duty reinforced skirt with an elasticised hem front and rear providing a strong guard against damage from sharp objects.

PROTECTION

The cover will provide excellent protection against acid rain, industrial pollutants, tree sap, bird droppings, dust and weather damage caused by leaving your Motorhome uncovered whilst exposed to the weather.

PRACTICALITY

Incorporated into the complete range of Camec premium motorhome covers which are lightweight and easy to fit are practical features such as nylon straps attached to both the front and rear plus four reinforced tabs with eyelets at both front and rear so that the cover can be made nice and taut ensuring it is securely fastened for all weather conditions.

FEATURES

- 300D water resistant UV 50+ roof section
- Water resistant breathable side panel
- Reinforced skirt with dual nylon clips
- Double stitched reinforced corners
- Ventilation flaps
- Soft non abrasive lining

THE ONLY ONE, THE ALL IN ONE

DRW SERIES

YOU DECIDE.
ANY TEMPERATURE,
ANY TIME.



DRW180A

Choose the temperature of the two drawers at any time. You can decide to have both in freezer mode, or in refrigerator mode, but also to alternate refrigerator and freezer or vice-versa.

DRW70A

Set it as a freezer or refrigerator and to change the mode easily and immediately.

ALL IN ONE STAINLESS STEEL DRAWERS
FRIDGES AND FREEZERS

DRW180A



DRW70A



R290



NATURAL
GAS

AS SLIM AS EVER

SLIM 150

SPECIFICALLY DESIGNED FOR THE RV APPLICATION SLIM 150 is suitable for use in any indoor space where it is necessary to achieve a high capacity distributed in both freezer and refrigerator mode.



COOLS FASTER
LASTS LONGER

3+DAYS RUN FOR
3 OR MORE DAYS
ON A 100 A/H
LEISURE BATTERY.



SAVE YOUR MONEY
AND
THE ENVIRONMENT



NIGHT
MODE



TURBO
MODE



VENT
POSITION



3-STAR
FREEZER

MADE IN ITALY

VITRIFRIGO
COOL AND BEYOND

VALLEFOGLIA (PU) - ITALY

www.vitrifrigo.com



APPLIANCES

- Air Conditioning. 56
- Fridges 57
- Ice Makers 71
- Fridge Accessories. 73
- Fridge Spare Parts. 74
- Microwaves. 76
- Rangehoods & Stoves 77
- Washing Machines 78

AIR CONDITIONING

Webasto RV Air Conditioners are the most effective units on the market. With many outstanding features including exceptional cooling capacity, low noise and a stylish low profile streamline design. Made using UV stabilised polypropylene the units are robust, yet still lightweight. They are the perfect investment to combat the harsh Australian climate.

Complete with an easy to handle remote control that lets you choose between heating, cooling, dry, sleep and timing functions. These functions allow your air-conditioning system to operate effectively in temperatures as low as -5°C and as high as 50°C.

Webasto Air Conditioners have excellent reverse cycle performance and are supplied with a 2 year Australia wide warranty and on-going technical support.

FEATURES

- 220-240 V
- Cooling Capacity from 2400 W up to 3400 W
- Low profile, slimline design
- Low noise
- High quality compressor and components
- Operates in temperatures as low as -5°C and as high as 50°C.
- Remote control to select heating, cooling, dry, sleep and timing functions
- Reverse cycle air-conditioner with a three speed fan
- Patented spiral retractable duct for easy installation
- Easy to remove & clean Air filter
- Strong and lightweight UV stabilised cover designed to withstand the toughest conditions
- 2 year Australia wide warranty



WEBASTO COOL TOP TRAIL 24
051505



WEBASTO COOL TOP TRAIL 34
051506



WEBASTO SPARE PARTS

CODE	PRODUCT NAME
051651	WEBASTO 2.4 COVER
051652	WEBASTO 2.4 AXIAL FAN OUTSIDE - W/CAPACITOR CTT24
051653	WEBASTO 2.4 AXIAL FAN INSIDE - W/CAPACITOR CTT24
051654	WEBASTO 2.4 CAPACITOR - COMPRESSOR CTT24
051655	WEBASTO 2.4 PC BOARD
051656	WEBASTO 2.4 FILTER - RETURN AIR CTT24
051657	WEBASTO 3.4 AXIAL FAN OUTSIDE
051658	WEBASTO 3.4 CAPACITOR - AXIAL FAN INSIDE CTT34
051659	WEBASTO 3.4 CAPACITOR - AXIAL FAN INSIDE CTT34
051660	WEBASTO 3.4 PC BOARD
051661	WEBASTO 3.4 FILTER
051662	WEBASTO 2.4/3.4 REMOTE CONTROL
051680	WEBASTO 2.4/3.4 EURO ADAPTER - 400X400MM CUT-OUT
051737	WEBASTO 2.4/3.4 DUCT REDUCER - 90-60MM

SPECIFICATIONS	TOP TRAIL 24	TOP TRAIL 34
NOMINAL VOLTAGE (V) / FREQUENCY (HZ)	220-240/50	220-240/50
RATING COOLING (KW)	2.4	3.4
RATED HEATING (KW)	2.4	3.0
RATED CURRENT COOLING / HEATING / MAX (A)	4.2/3.8/4.5	5.8/5.4/7.4
UNIT NET WEIGHT OUTDOOR (KG)	29	45
UNIT NET WEIGHT INDOOR (KG)	3	3
OPERATING TEMPERATURE RANGE (C)	-5 TO 50	-5 TO 50
ROOF THICKNESS (MM)	25 TO 85	25 TO 70
ROOFTOP CUT-OUT (MM) - (OPTIONAL ADAPTOR)	360 X 360 - (400 X 400)	360 X 360 - (400 X 400)
DIMENSIONS OUTDOOR (L) X (W) X (H) MM	1002 X 566 X 215	1122 X 850 X 223
DIMENSIONS INDOOR (L) X (W) X (H) MM	557 X 536 X 43	575 X 556 X 49

FRIDGES



VITRIFRIGO DP2600i CHR BLACK 2 DOOR FRIDGE/FREEZER 230LT BD-50 COMPRESSOR WITH FITTING FRAME AND AIR LOCK 12/24/240V

051578

TOTAL VOLUME	230LT
FREEZER COMPARTMENT	60LT
NET WEIGHT	58.5KG
POWER SUPPLY AND NOMINAL CONSUMPTION	12/24 VDC 65W 240V
MINIMUM CUT OUT REQUIRED	1345 (H) X 595 (W) X 602 (D)

FEATURES

- Internal LED light
- Measurements do not include fitting frame

CHROMELOCK SERIES

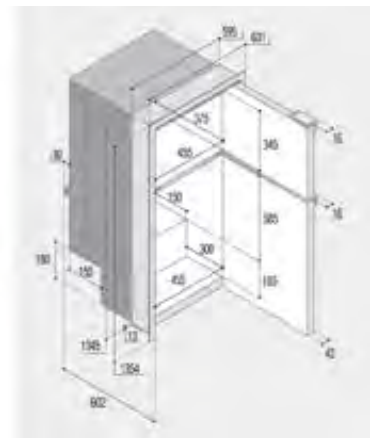
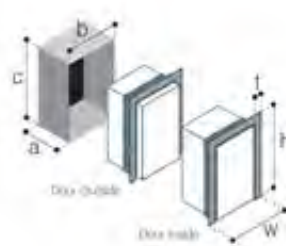

VITRIFRIGO DP150i CHR 2 DOOR FRIDGE/FREEZER 150LT AIR LOCK 12-24V-240V

051585

TOTAL VOLUME	150LT
FREEZER COMPARTMENT	30LT
NET WEIGHT	43KG
POWER SUPPLY AND NOMINAL CONSUMPTION	12/24 VDC 65W/240V

FEATURES

- Internal LED light

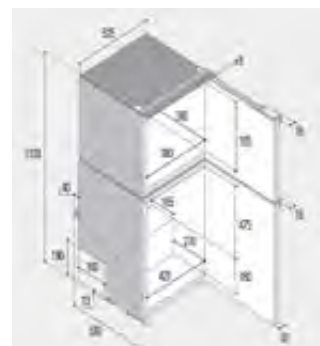

	DOOR	INSIDE	OUTSIDE
MOUNTING FLANGE	T:	25	25
	W:	588	588
	H:	1107	1107
BUILT-IN	A:	565	523
	B:	540	540
	C:	1095	1095



VITRIFRIGO C115i CHR FRIDGE/FREEZER 115LT 12/24/240V WITH FITTING FRAME AND AIR LOCK

051575

TOTAL VOLUME	115LT
FREEZER COMPARTMENT	17.1LT
NET WEIGHT	21.2KG
POWER SUPPLY AND NOMINAL CONSUMPTION	12/24 VDC 45W/240V

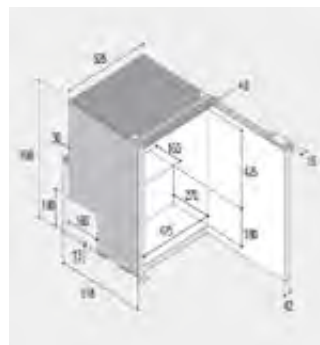

FEATURES

- Internal LED light

	DOOR	INSIDE	OUTSIDE
MOUNTING FLANGE	T:	25	25
	W:	588	588
	H:	804	804
BUILT-IN	A:	556	513
	B:	540	540
	C:	768	768



VITRIFRIGO C85i FRIDGE/FREEZER 12/24/240V AIR LOCK

051580

051576 LHH

TOTAL VOLUME	85LT
FREEZER COMPARTMENT	12.8LT
NET WEIGHT	23.3KG
POWER SUPPLY AND NOMINAL CONSUMPTION	12/24 VDC 45W/240V

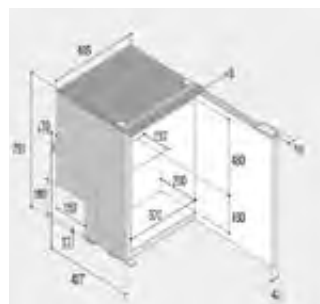

FEATURES

- Internal LED light

	DOOR	INSIDE	OUTSIDE
MOUNTING FLANGE	T:	25	25
	W:	548	548
	H:	829	829
BUILT-IN	A:	464	422
	B:	500	500
	C:	792	792



VITRIFRIGO C60i CHR FRIDGE/FREEZER 12/24/240V AIR LOCK

051592

TOTAL VOLUME	60LT
FREEZER COMPARTMENT	10.2LT
NET WEIGHT	18.6KG
POWER SUPPLY AND NOMINAL CONSUMPTION	12/24 VDC 40W/240V

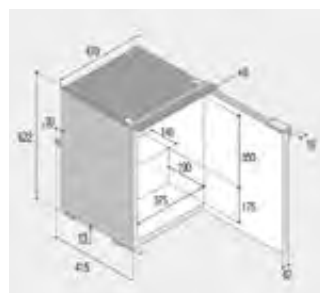

FEATURES

- Internal LED light

	DOOR	INSIDE	OUTSIDE
MOUNTING FLANGE	T:	25	25
	W:	533	533
	H:	659	659
BUILT-IN	A:	453	410
	B:	485	485
	C:	623	623



VITRIFRIGO C39i FRIDGE/FREEZER 12/24/240V AIR LOCK

051313

TOTAL VOLUME	39LT
FREEZER COMPARTMENT	3.6LT
NET WEIGHT	16KG
POWER SUPPLY AND NOMINAL CONSUMPTION	12/24 VDC 31W/240V

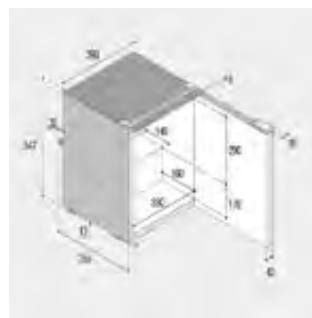

FEATURES

- Internal LED light

	DOOR	INSIDE	OUTSIDE
MOUNTING FLANGE	T:	25	25
	W:	453	453
	H:	584	584
BUILT-IN	A:	393	350
	B:	405	405
	C:	548	548



REMOVABLE COOLING UNIT

The removable external cooling unit offers added available volume inside the refrigerator. In addition, it expands the installation possibilities in terms of functionality, efficiency and soundproofing.

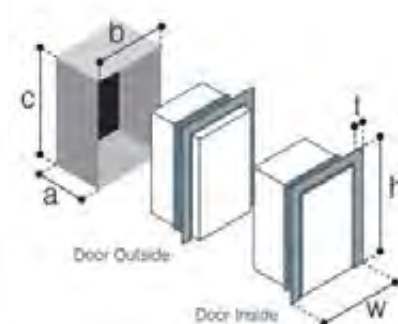

VITRIFRIGO C130L CHR EXTERNAL COMPRESSOR AIR LOCK

051584 REFRIGERATOR ONLY
 051586 FRIDGE/FREEZER
 051587 FRIDGE/FREEZER S/S

TOTAL VOLUME	130LT
FREEZER COMPARTMENT	17.1LT
NET WEIGHT	25.2KG
POWER SUPPLY AND NOMINAL CONSUMPTION	240/12/24 VDC 45W

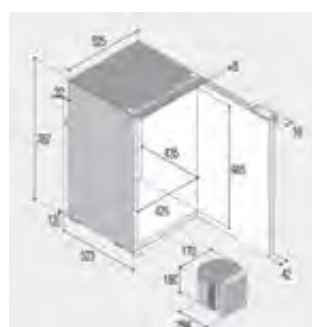

	DOOR	INSIDE	OUTSIDE
MOUNTING FLANGE	T:	25	25
	W:	588	588
	H:	804	804
BUILT-IN	A:	560	518
	B:	540	540
	C:	768	768



VITRIFRIGO C75L CHR FRIDGE/FREEZER 75LT 12-24V/240V EXTERNAL COMPRESSOR AIR LOCK

051579

TOTAL VOLUME	75LT
FREEZER COMPARTMENT	10.2LT
NET WEIGHT	18.6KG
POWER SUPPLY AND NOMINAL CONSUMPTION	12/24 VDC 40W /240V

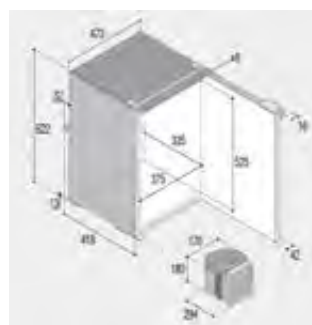

FEATURES

- External compressor:
294(L) x 170(W) x 180(H)

	DOOR	INSIDE	OUTSIDE
MOUNTING FLANGE	T:	25	25
	W:	533	533
	H:	659	659
BUILT-IN	A:	456	413
	B:	485	485
	C:	623	623

VITRIFRIGO C75DW CHRO DRAW FRIDGE/FREEZER EXTERNAL COMPRESSOR AIR LOCK

051266 C75DW CHR

TOTAL VOLUME	75LT
FREEZER COMPARTMENT	10.2LT
NET WEIGHT	21.6KG
POWER SUPPLY AND NOMINAL CONSUMPTION	12/24 VDC 40W

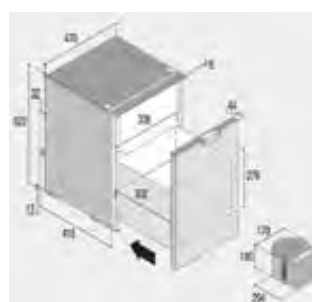

FEATURES

- External compressor:
294(L) x 170(W) x 180(H)

	DOOR	INSIDE	OUTSIDE
MOUNTING FLANGE	T:	25	25
	W:	533	533
	H:	659	659
BUILT-IN	A:	413	413
	B:	485	485
	C:	623	623

VITRIFRIGO SLIM 150 SERIES

SLIM 150

A COMPLETE RESTYLING TO OFFER HIGHER PERFORMANCE. THE NEW DOOR: with the new anti-fingerprint and scratch-resistant finish with soft touch effect panel and the new handle of the Chromelock series, the new door is lighter, in the face of greater thickness and strength. THE NEW DRAWER: Completely redesigned to be lighter, while optimizing the containment and division of the internal space, thanks to the new re-positionable partition in blue plexiglass. THE NEW PERFORMANCES: Equipped with a latest generation compressor, the SLIM150 reaches the desired temperature in a very short time, ensuring continuous operation at the top of the category.



VITRIFRIGO SLIM 150 - 140L EXTERNAL COMPRESSOR AIR LOCK

050091 MATTE BLACK W/ ANTI-FINGERPRINT AND SCRATCH RESISTANT FINISH

051695 GREY/SILVER

TOTAL VOLUME	140LT
FREEZER COMPARTMENT	16LT
NET WEIGHT	37KG
POWER SUPPLY AND NOMINAL CONSUMPTION	12/24 VDC 70W/240V



FEATURES

- Also available in matte black
- Reversible door
- Slide out freezer drawer at bottom
- Internal LED light
- Multi function thermostat with integrated blue LED
- External compressor can be mounted up to 1.5m away.
- External compressor: 325(L) x 170(W) x 180(H)



VITRIFRIGO SLIM 90

051768 BLACK SLIM 90

051767 GREY SLIM 90

TOTAL VOLUME	82LT
FREEZER COMPARTMENT	10LT
NET WEIGHT	19.3KG
POWER SUPPLY AND NOMINAL CONSUMPTION	12/24 VDC 39W

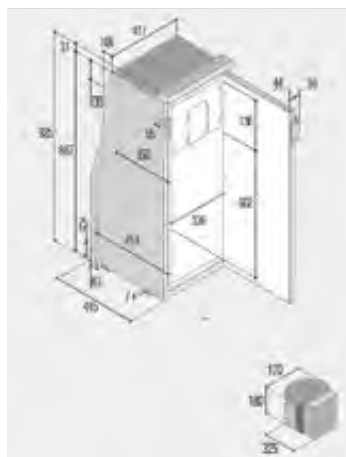

VITRIFRIGO HOME COMFORT SERIES

PERFECT INTERNAL SANITISATION

The interior walls of the refrigerators are treated by a natural system to inhibit the onset of mould and bacteria and to protect the integrity of food, while the innovative gaskets ensure the protection of even the outermost areas of the refrigerator.

HIGH POTENTIAL LIGHTING

The internal lighting system includes the standard installation of a very bright top light making sure all parts of the refrigerator are properly lit.

FRESH AND CRISP FRUIT AND VEGETABLES

The perfect control of humidity levels, together with minimised temperature variations inside the fruit and vegetable drawer, mean that stored food is kept fresh and crisp



VITRIFRIGO C220DP FRIDGE (WHITE ONLY)

044465 LEFT HINGE

044466 RIGHT HINGE

TOTAL VOLUME	220LT
FREEZER COMPARTMENT	42LT
NET WEIGHT	42.5KG
POWER SUPPLY AND NOMINAL CONSUMPTION	12/24 VDC 56W/240V

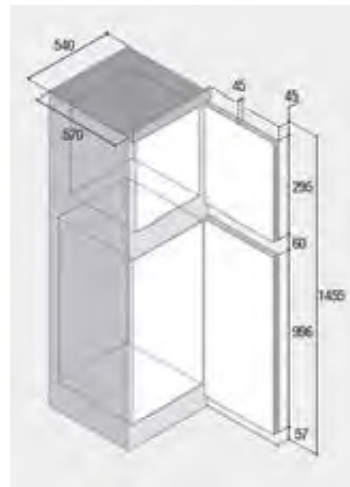

VITRIFRIGO C190 MP DX

051685 12/24/240V

TOTAL VOLUME	200LT
FREEZER COMPARTMENT	19LT
NET WEIGHT	39KG
POWER SUPPLY AND NOMINAL CONSUMPTION	12/24 VDC 56W



VITRIFRIGO OUTBACK DRW SERIES

THE ULTIMATE IN FREEDOM

DRW180A gives you the freedom to choose the temperature of the two drawers at any time. You can decide to have both in freezer mode, or in refrigerator mode, but also to alternate refrigerator and freezer or vice-versa. DRW70A gives you the ability to set it as a freezer or refrigerator and to change the mode easily and immediately

MADE IN ITALY DESIGN AND QUALITY

New elegant square profile door design featuring the new Steelock handle with AISI 316 stainless steel finish. Total interchangeability with the previous DW180 and DW70 models.

THERMOSTAT WITH TOUCH SCREEN

The new Steelock multi-function flush door handle in AISI 316 stainless steel, integrates a thermostat with touch screen controls for digital temperature control: DRW180A relative to the two drawers, choosing between refrigerator (+4°C) or freezer (-18°C). DRW70A refrigerator (+4°C) or freezer (-18°C)

INTEGRATED VENT POSITION

The device integrated in the Steelock OCX2 handle offers the “vent position” function, allowing the door to be held ajar and thus avoiding the formation of mould and odours during periods of non-use.

INTERIOR LED LIGHT SYSTEM

Interior LED lighting with high brightness and minimum consumption.

DOOR INSIDE / DOOR OUTSIDE

The position of the door (flush or external) is achieved by simply moving the special single stainless steel fixing profile (supplied standard) with slotting for improved air circulation and cooling efficiency. In addition, the refrigerator can be attached to the recessed compartment from the inside.

3-STAR FREEZER AND TOTAL NO FROST

The lower drawer of the DRW180A is able to maintain an internal temperature of -18°C compared to an ambient temperature of up to 43°C, while a new and efficient ventilation system ensures more effective food storage.

NEW GENERATION DRAWERS

The new sliding guides of the drawers guarantee perfect closure and gentle and silent movement. In addition, the drawers are equipped with internal dividers to optimise distribution of the contents



	DOOR	INSIDE	OUTSIDE
MOUNTING FLANGE	T:	25	25
	W:	666	666
	H:	874	874
BUILT-IN	A:	590	540
	B:	617	617
	C:	857	857

VITRIFRIGO DRW180A

050746 180A DRAW FRIDGE S/S

MULTI-OPTION

2 freezer drawers or 2 x refrigerator drawers
or 1 x refrigerator 1 x freezer or 1 x freezer 1 x refrigerator

TOTAL VOLUME	150LT
NET WEIGHT	55KG
POWER SUPPLY	12/24 VDC / 240V
MAX ABSORBED POWER DURING DEFROST	130W
MAX CONSUMPTION POWER DURING DEFROST	10.5A 12/24VDC
MAX CONSUMPTION - NORMAL OPERATION	8A 12VDC / 4A 24VDC

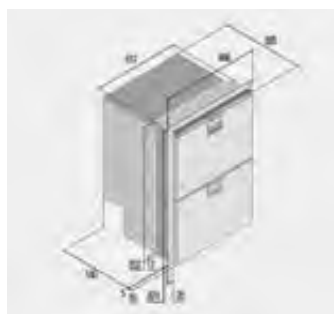

FEATURES

- Steelock handle
- Touch screen thermostat
- Flush or external door fitting is achieved by simply sliding the supplied S/S fixing profile
- Cut out required: 617 (W) x 857 (H)



	DOOR	INSIDE	OUTSIDE
MOUNTING FLANGE	T:	25	25
	W:	666	666
	H:	467	467
BUILT-IN	A:	590	540
	B:	617	617
	C:	450	450

VITRIFRIGO DRW70A WITH EXTERNAL COMPRESSOR

051208

TOTAL VOLUME	80LT
NET WEIGHT	38KG
POWER SUPPLY	12/24 VDC
MAX ABSORBED POWER DURING DEFROST	130W
MAX CONSUMPTION POWER DURING DEFROST	10.5A 12/24VDC/ 240V
MAX CONSUMPTION - NORMAL OPERATION	8A 12VDC / 4A 24VDC

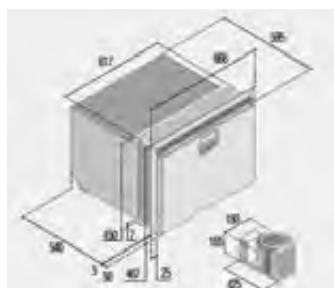

FEATURES

- Steelock handle
- Touch screen thermostat
- Drawer equipped with internal dividers to optimise distribution of contents
- Cut out required: 617 (W) x 450 (H)

VITRIFRIGO OUTBACK DW SERIES

ELEGANCE AND DESIGN

Designed to transform the refrigerator into an elegant piece of furniture, they express an understated and refined style, successfully interpreting the unique personality of your vehicle. Available in configurations ranging from a generous 300 litres to the smallest of just 35 litres, and with the possibility for refrigerator, freezer and ice-maker functions, with internal or external motor, they are truly able to meet any type of need and positioning on-board

NEW GENERATION DOORS

The new sliding guides of the drawers guarantee perfect closure and gentle and silent movement. In addition, the drawers are equipped with internal dividers to optimise distribution of the contents.

DOOR INSIDE / DOOR OUTSIDE

The position of the door (flush or external) is achieved by simply moving the special single stainless steel fixing profile (supplied standard) with slotting for improved air circulation and cooling efficiency. In addition, the refrigerator can be attached to the recessed compartment from the inside.

PRECISE TEMPERATURE CONTROL

Temperature control is provided by an innovative LED thermostat able to offer maximum precision in the selection of refrigeration degrees.

INTERNAL LED LIGHT SYSTEM

All models (with the exception of the DW35) are equipped with an internal LED light system that offers high brightness with minimum consumption.

INTERGRATED VENT POSITION

A smart device, incorporated in the Steelock OCX2 handle, realizes the "vent position" function, keeping the fridge door slightly open to prevent unpleasant odours when not in use.

REMOVABLE COOLING UNIT

The removable external cooling unit (In models with external cooling unit) offers added available volume inside the refrigerator. In addition, it expands the installation possibilities in terms of functionality, efficiency and soundproofing.



VITRIFRIGO DW 360

051397 DW360 DTX OCX2

051683 DW360 BTX OCX2 12/24V/240V

051234 DW 360 BTX OCX2 12/24/240V

051233 DW360 BTX OCX2 12/24/240V

POWER SUPPLY AND NOMINAL CONSUMPTION

NET WEIGHT

		12/24 VDC	12/24 VDC	230 VAC	
DW360 OCX2	A	B	B		
BTX	45W	61W	-		102KG
DTX	45W	61W	-		102KG

FEATURES

- With doors mounted 'flush' (D) = 591mm
- With doors mounted external (D) = 550mm
- Cut out required: 637 (W) x 1695 (H)
- Sizes shown include fitting frame

BTX = Top door refrigerator, bottom drawers both freezers

DTX = Top door refrigerator, top drawer freezer, bottom drawer refrigerator

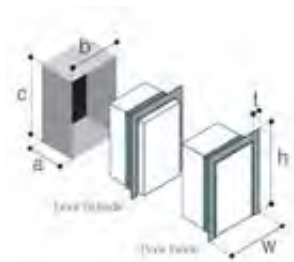

	DOOR	INSIDE	OUTSIDE
MOUNTING FLANGE	T:	25/40	25/40
	W:	682	682
	H:	1697	1697
BUILT-IN	A:	591	550
	B:	637	637
	C:	1695	1695

VITRIFRIGO DW250 FREEZER/FREEZER

051121 BTX OCX2 12/24/240V



POWER SUPPLY AND NOMINAL CONSUMPTION

NET WEIGHT

	12/24 VDC	12/24 VDC	67KG
DW250 OCX2	A	B	
BTX	45W	38W	



	DOOR	INSIDE	OUTSIDE
MOUNTING FLANGE	T: 25/40	25/40	
	W: 682	682	
	H: 1321	1321	
BUILT-IN	A: 584	542	
	B: 637	637	
	C: 1318	1318	

VITRIFRIGO C180RFX OCX2 12-24/240V STAINLESS STEEL FRIDGE ONLY

051681



POWER SUPPLY AND NOMINAL CONSUMPTION

NET WEIGHT

C180 OCX2	12/24 VDC	45W	41KG
------------------	-----------	-----	------

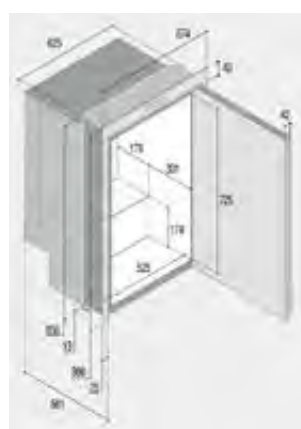

	DOOR	INSIDE	OUTSIDE
MOUNTING FLANGE	T: 25/40	25/40	
	W: 674	674	
	H: 866	866	
BUILT-IN	A: 561	517	
	B: 625	625	
	C: 856	856	

VITRIFRIGO DW70 CX2

051438

051559 BTX IM 230V

051712 FRIDGE 12/24/240V

051713 FREEZER 12/24/240V

POWER SUPPLY AND NOMINAL CONSUMPTION

NET WEIGHT

	12/24 VDC	115 VAC	230 VAC	
DW70 OCX2				
RFX	38W	-	-	33KG
BTX	40W	-	-	33KG
BTX IM		168W	140W	38KG



FEATURES

- Total depth: 588 mm (Door Outside)
626 mm (Door Inside)

	DOOR	INSIDE	OUTSIDE
MOUNTING FLANGE	T: 25/40	25/40	
	W: 666	666	
	H: 460	460	
BUILT-IN	A: 592	548	
	B: 617	617	
	C: 450	450	



VITRIFRIGO DW35

043967



POWER SUPPLY AND NOMINAL CONSUMPTION

NET WEIGHT

	12/24 VDC	12/24 VDC	67KG
DW250	A	B	
OCX2			
BTX	45W	38W	



	DOOR	INSIDE	OUTSIDE
MOUNTING FLANGE	T:	25/40	25/40
	W:	498	498
	H:	291	291
BUILT-IN	A:	727	675
	B:	450	450
	C:	285	285

VITRIFRIGO DW180 OCX2

051375 FRIDGE / FREEZER

051694 FRIDGE / FRIDGE



POWER SUPPLY AND NOMINAL CONSUMPTION

NET WEIGHT

	12/24 VDC	115 VAC	230 VAC	
DW180				
OCX2				
RFX	45W	-	-	56KG
BTX	61W	-	-	56KG
DTX	61W	-	-	56KG
BTX IM	-	168W	140W	61KG
DTX IM	-	168W	140W	61KG

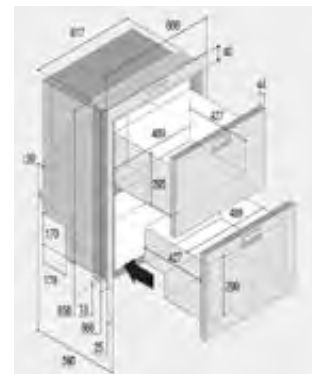

	DOOR	INSIDE	OUTSIDE
MOUNTING FLANGE	T:	25/40	25/40
	W:	666	666
	H:	866	866
BUILT-IN	A:	590	546
	B:	617	617
	C:	856	856

VITRIFRIGO DW100 OCX2

- 051714 FRIDGE
- 051582 FREEZER
- 051577 FRIDGE S/S

POWER SUPPLY AND NOMINAL CONSUMPTION

NET WEIGHT

DW100 OCX2	12/24 VDC / 240V	
RFX	40W	32KG
BTX	52W	32KG

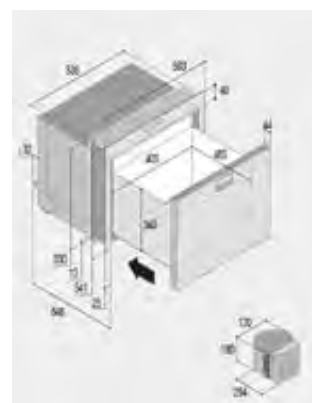

	DOOR	INSIDE	OUTSIDE
MOUNTING FLANGE	T:	25/40	25/40
	W:	583	583
	H:	541	541
BUILT-IN	A:	646	603
	B:	535	535
	C:	530	530

VITRIFRIGO DW210 OCX2

- 039882 FREEZER (TOP) / FRIDGE
- 051521 BTX FREEZER / FREEZER 12/24V
- 051125 240V WITH ICE MAKER
- 051684 FREEZER (TOP) / FRIDGE 12/24/240V
- 051696 RF FRIDGE/FRIDGE 12/24/240V
- 051699 BT FREEZER / FREEZER 12/24/240V

POWER SUPPLY AND NOMINAL CONSUMPTION

NET WEIGHT

DW 210 OCX2	12/24 VDC	115 VAC	230 VAC	
RFX	45W	-	-	61KG
BTX	61W	-	-	61KG
DTX	61W	-	-	61KG
BTX IM	-	168W	140W	66KG
DTX IM	-	168W	140W	66KG

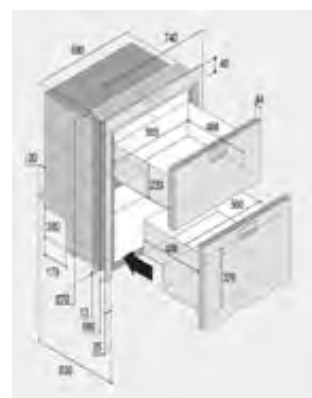

	DOOR	INSIDE	OUTSIDE
MOUNTING FLANGE	T:	25/40	25/40
	W:	740	740
	H:	880	880
BUILT-IN	A:	630	585
	B:	690	690
	C:	870	870



VITRIFRIGO OUTBACK STAINLESS STEEL SERIES

Renewed both in design and functionality.

THE OCX2 SYSTEM

The new OCX2 version offers multiple advantages: 1) positive snap closure of the door to avoid accidental openings; 2) single fixing profile (optional), to fix the refrigerator in a partial (door outside) or total (door inside) recess position; 3) reversibility of the door: thanks to the measures adopted during the design phase, this is a simple and quick operation to perform.

DOOR INSIDE / DOOR OUTSIDE

The position of the door (flush or external) is achieved by simply moving the special single stainless steel fixing profile (supplied standard) with slotting for improved air circulation and cooling efficiency. In addition, the refrigerator can be attached to the recessed compartment from the inside.

INTERNAL LED LIGHT SYSTEM

All models are equipped with an internal LED light system that offers high brightness with minimum consumption.

INTEGRATED VENT POSITION

The device integrated in the Steelock handle achieves the “vent position” function, allowing the door to be held ajar, thus avoiding the formation of mould and unpleasant odours during periods of non-use

REMOVABLE COOLING UNIT

The removable external cooling unit (In models with external cooling unit) offers added available volume inside the refrigerator. In addition, it expands the installation possibilities in terms of functionality, efficiency and soundproofing. It can be mounted up to 1.5m away from the main fridge.



VITRIFRIGO DP2600IX STAINLESS STEEL 2 DOOR FRIDGE/FREEZER 230LT 12-24V BD-50 COMPRESSOR WITH FITTING FRAME AND STEELOCK OCX2

05 1588

TOTAL VOLUME	230LT
FREEZER COMPARTMENT	60LT
NET WEIGHT	63KG
POWER SUPPLY AND NOMINAL CONSUMPTION	12/24 VDC 65W/240V

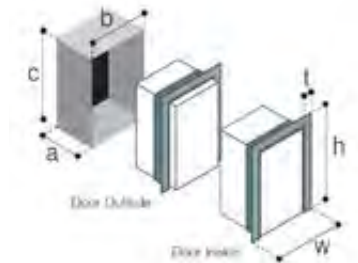
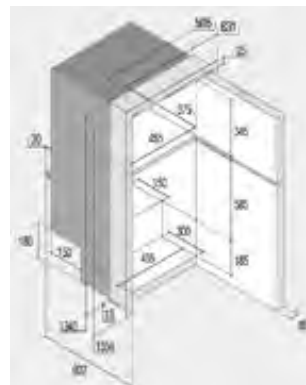

VITRIFRIGO C 115IAX OCX2 FRIDGE

05 1312

TOTAL VOLUME	115LT
FREEZER COMPARTMENT	17.1LT
NET WEIGHT	32KG
POWER SUPPLY AND NOMINAL CONSUMPTION	12/24 VDC 45W/240V

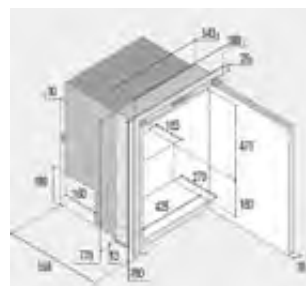

	DOOR	INSIDE	OUTSIDE
MOUNTING FLANGE	T:	25	25
	W:	588	588
	H:	780	780
BUILT-IN	A:	558	515
	B:	543	543
	C:	770	770



VITRIFRIGO C62iX OCX2 S/S 62LT 12/24/240V

051581

TOTAL VOLUME	62LT
FREEZER COMPARTMENT	4.51LT
NET WEIGHT	22KG
POWER SUPPLY AND NOMINAL CONSUMPTION	12/24 VDC 40W/240V

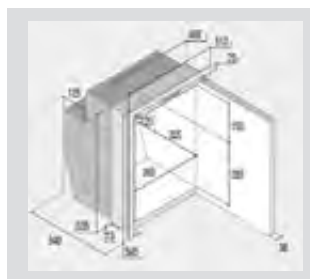

	DOOR	INSIDE	OUTSIDE
MOUNTING FLANGE	T:	25	25
	W:	513	513
	H:	545	545
BUILT-IN	A:	540	482
	B:	468	468
	C:	535	535



VITRIFRIGO C75LX OCX2 STAINLESS STEEL FRIDGE 75LT 12-24V AND EXTERNAL COMPRESSOR WITH STEELOCK

051682

TOTAL VOLUME	75LT
FREEZER COMPARTMENT	10.2LT
NET WEIGHT	25KG
POWER SUPPLY AND NOMINAL CONSUMPTION	12/24 VDC 40W/240V

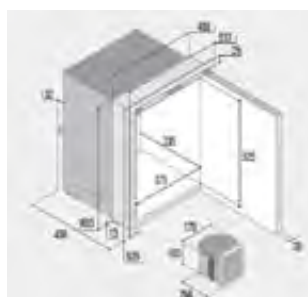

	DOOR	INSIDE	OUTSIDE
MOUNTING FLANGE	T:	25	25
	W:	533	533
	H:	635	635
BUILT-IN	A:	456	413
	B:	488	488
	C:	625	625



VITRIFRIGO C130LX OCX2 FRIDGE 130LT 12/24/240V AND EXTERNAL COMPRESSOR WITH STEELOCK STAINLESS STEEL

051587

TOTAL VOLUME	130LT
FREEZER COMPARTMENT	17.1LT
NET WEIGHT	33KG
POWER SUPPLY AND NOMINAL CONSUMPTION	12/24 VDC 45W/240V

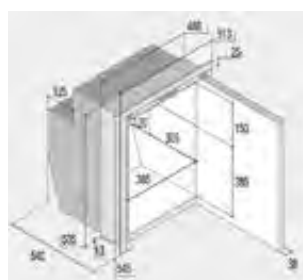

	DOOR	INSIDE	OUTSIDE
MOUNTING FLANGE	T:	25	25
	W:	513	513
	H:	545	545
BUILT-IN	A:	540	482
	B:	468	468
	C:	535	535

VITRIFRIGO C110BT 108L 12/24/240V FREEZER WITH EXTERNAL COMPRESSOR

051583



	DOOR	INSIDE	OUTSIDE
MOUNTING FLANGE	T:	25	25
	W:	588	588
	H:	804	804
BUILT-IN	A:	560	518
	B:	540	540
	C:	768	768

VITRIFRIGO C42LX OCX2

044977 12/24/240V

051318 OCX 12/24051560/240V



TOTAL VOLUME	42LT
FREEZER COMPARTMENT	3.6LT
NET WEIGHT	18KG
POWER SUPPLY AND NOMINAL CONSUMPTION	12/24 VDC 31W

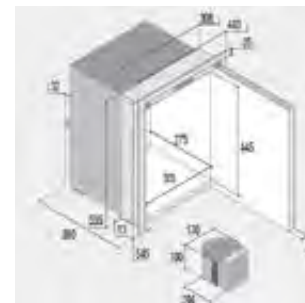

	DOOR	INSIDE	OUTSIDE
MOUNTING FLANGE	T:	25	25
	W:	443	443
	H:	545	545
BUILT-IN	A:	380	337
	B:	398	398
	C:	535	535

ICE MAKERS



VITRIFIRGO ICE MAKER HYDRO 24L

043558

Classic Ice Maker that is plumbed to the vessel or RV's fresh water system. Constructed from marine grade 316 stainless steel.

FEATURES

- Cooling unit is vented through the front
- Door can be mounted left or right and has magnetic closure
- Dual function thermostat – ice production/ice maintenance

SPECIFICATIONS

- Dimensions: 404mm (l) x 628mm (h) x 370mm (d)
- Ice Production: 11kg/24hrs; 6kg ice storage
- Weight: 26kg
- Power Voltage: 240V or 110V
- Current Consumption: 140W
- Includes 6m inlet hose (can be reduced)
- Capacity: 24 litres



VITRIFIRGO IM HYDRO XTP ICE MAKER 24L

043560

Low profile Ice Maker that is plumbed to the vessel or RV's fresh water system. Constructed from marine grade 316 stainless steel.

FEATURES

- Cooling unit is centred through the front
- Door can be mounted left or right and has magnetic closure
- Dual function thermostat – ice production/ice maintenance

SPECIFICATIONS

- Dimensions: 387mm (l) x 522mm (h) x 513mm (d)
- Ice Production: 11kg / 24hrs; 6kg ice storage
- Weight: 28kg
- Power voltage: 240V
- Current Consumption: 140W
- Includes 6m inlet hose (can be reduced)
- Capacity 24 litres

VITRIFRIGO CODE CHART

STAINLESS STEEL DRAWER REFRIGERATORS

DRW	ALL IN ONE drawer refrigerators series
DW OCX2	OCX2 drawer refrigerators series
DW	drawer refrigerators series
RF	refrigerator version
BTX	freezer version
BTX IM	freezer version with internal icemaker
DTX	refrigerator-freezer version
DTX IM	refrigerator-freezer version with internal icemaker

STAINLESS STEEL DRAWER REFRIGERATORS AND FREEZERS WITH BUILT IN/REMOTE UNIT OCX2 SERIES

C OX2	OCX2 refrigerators and freezers series with front door opening
I	internal cooling unit version
L	external cooling unit version
X	stainless steel version
DW	drawer version
DW OCX2	OCX2 drawer version series

REFRIGERATORS AND FREEZERS WITH BUILT IN/REMOTE UNIT CHROMELOCK SERIES

CHR	refrigerators and freezers series with front door opening
DP	double door refrigerator version
I	internal cooling unit version
L	external cooling unit version
DW	drawer version

REFRIGERATORS AND FREEZERS SLIM SERIES

SLIM	refrigerators and freezers series SLIM series with front door opening
------	---

TOP LOADING REFRIGERATORS

TL	top loading refrigerators series
L	external cooling unit
RF	refrigerators version
BT	freezer version

HOME COMFORT REFRIGERATORS-FREEZERS

C	refrigerators and freezers series with front door opening
DP	double door refrigerator version
MP	single door refrigerator version

SPECIAL INSTALLATION REFRIGERATORS

D	all in one compact drawer refrigerators-freezers series
P	BRK35 version with PUSH-PULL lock
PX	stainless steel BRK35 version with PUSH-PULL lock

PORTABLE REFRIGERATORS AND FREEZERS

VF	portable refrigerators and freezers VFREE series
----	--



ENGEL SR70F 57LT BUILT IN FRIDGE/FREEZER

003201

Compact built in fridge with an area for frozen goods, to suit most camper vans or yachts. Maximization of storage capacity allows you to separate beverages and perishables easily. Auto switching between 12/24V DC and 240V AC. Reversible door and replaceable door panel so you can customize your refrigerator to match your vehicle's interior. Turbo fan standard.

FEATURES

- No exterior skin but with frame type door with replaceable door panel

SPECIFICATIONS

- Dimensions: 506mm(w) x 530mm(h) x 586mm(d)
- Cut out dimensions: 467mm(w) x 518mm(h) x 526mm(d)
- Capacity: 57 litre
- 12/24V DC (2.5/1.3A)
- 28KG



ENGEL ST90F 80LT FREE STANDING FRIDGE

003204

Large capacity 80 litre free-standing fridge that incorporates a separate freezing compartment. Cleverly designed to fit into confined spaces in caravans and boats. Unique auto switching between 12/24V DC and 240V AC standard in most of Engel's uprights SR48F, SR70F. Reversible door and replaceable door panel so you can customize your refrigerator to match your vehicle's interior. Turbo fan standard.

FEATURES

- Variable from 0.5 to 2.5amp maximum

SPECIFICATIONS

- Dimensions: 531mm(w) x 786mm(h) x 579mm(d)
- Cut out: 505mm(d)
- Voltage: 240V AC/12V DC/24V DC
- Capacity: 80Lt
- 70Lt Fridge, 10Lt Freezer
- 12/24V (2.5/1.3A)
- 28KG

FRIDGE ACCESSORIES



SOLAR FRIDGE FAN

000684

Solar powered exhaust fan increases the cooling efficiency of refrigerator by venting hot air from the coils.



FRIDGE SIDE SCREEN WITH RAIL

050021

Improves the efficiency of your fridge on a hot day.

SPECIFICATIONS

- Size: 1900mm x 900mm
- Colour: silver/Grey
- Comes with pegs, ropes and sail track
- 199gsm, 95% shade cloth.



FRIDGE FAN

000688

FRIDGE SPARE PARTS

CODE	PRODUCT NAME
038340	DW70 THERMOSTAT FRIDGE ONLY
038338	DW70 FREEZER AND DW180 FRIDGE/FREEZER THERMOSTAT
040909	DW70RF, DW100RF R5021070.S THERMOSTAT
043820	DW70BT FREEZER FITTING FRAME
043367	BW70BT SS DOOR W/HANDLE
043429	DW100 FIT FRAME SUIT OUTSIDE PIN LOCK
051564	VITRI DOOR SEAL
039813	DW180 BOTTLE STOPPER ANCHORAGE
040907	DW180BT-DT DW70BT AND DW100BT R502.1018BT.S THERMOSTAT
041396	DW180 / DW70 VENT
042487	DW180DT DRIP TRAY
033857	DW180 DRAWER HANDLE R14025
039115	DW180 S/S DRAWER COVER
036658	DW180.2 DRAWER RUNNER
044693	DW180/70 FITTING FRAME / VENT KIT
039958	DW180/210 SX R-FRIDGE CLOSURE
039956	DW180 S/S SURFACE FLANGE
044692	DW180 STAINLESS FITTING FRAME
044689	DW180/70 STAINLESS FRONT
040308	DW210 BT/DT THERMOSTAT FRIDGE AND FREEZER
043944	DW210 DRAWER SEAL/LINER
043945	DW210 DRAWER SEAL/LINER
044406	DW210 FITTING FRAME
044189	DW 360 OLD STYLE CRISPER BIN
043821	C1200/C115/DP150 CRISPER SALAD CONTAINER
003121	DP150 FITTING FRAME
036571	DP150I 14023 DOOR LOCK
043263	DP150 THERMOSTAT BLACK KNOB
003132	C30 AND DP150I DOOR
043978	DP150 FRIDGE EVAPORATOR
003021	DP2600 FR EVAPORATOR
003094	DP2600 SS HINGE MANUFACTURED UP TO DEC 2013
042881	DP2600I/IX HINGE KIT NEW UPPER AND LOWER

CODE	PRODUCT NAME
003104	DP2600 DRAIN TRAY
041415	DP2600IX SS FREEZER DOOR SUIT NEW MODEL
042168	DP2600 BL FRIDGE DR NEW MODEL FOR NEW MODEL FRIDGES
042169	DP2600 BL FREEZER DR FOR NEW MODEL FRIDGES
043170	DP2600 GLASS SHELF
003082	DP2600 DOOR SHELVING (TOP) ALSO SUITS DP150
003176	DP2600 FESTOON 24V 3W GLOBE
043905	DP2600 PLAIN WIRE SHELF
051232	DP2600 SS DOOR ONLY
043907	DP2600I/IX CENTRE HINGE
044269	DP2600 PLASTIC SHELF
050005	DP2600 KIT
003112	NAUTIC LOCK ASSEMBLY SUIT CLASSIC DP2600 & OTHERS
003003	BD35F 12-24V COMPRESSOR
003009	BD35/50F 12-24V ELECT CONT UNIT (DANFOSS)
003004	BD50 12-24V COMPRESSOR
003017	C60/C75L/C85I EVAPORATOR "U" SHAPE CURRENT PLASTIC FREEZER DOOR
003105	C60/75 MOUNT FOR DOOR TOP FIXING TO CABINET
003086	C60/75 WIRE SHELF
003125	C60/C75 FITTING FRAME
043528	C60/C75L FREEZER DOOR
050624	C60/C75/C90 FIXING FRAME
039962	C60/C115 BOTTLE STOPPER
003027	C85/C115I/C130L O/T EVAP
003087	C85I/900 WIRE SHELF
003137	C85I FRIDGE DOOR PLUS KIT SHELF R501.435
043912	C85 AIRLOCK FRIDGE DOOR
043918	C85 AIRLOCK VEGE BIN
038555	C85I TOP DOOR SHELF
050625	C85/C95 FIXING FRAME
003166	C115I/130L EVAPORATOR "U" SHAPE CURRENT VERSION
043234	C115/C130 FREEZER DOOR PLASTIC INSULATED
043913	C115/130 AIRLOCK DOOR
050626	C115/C130/C110 FIXING FRAME
041695	C115/DP2600/5150-05 DOOR METAL RETAINER
003043	C26/45/60, BRK-35 T-STAT K50L3105
003061	C26/41 LID LOCK CLIP C1300 FREEZER DOOR CATCH
003041	C41 T-STAT E-TRONIC LED
003168	C41 MOUNTING BRACKET
003099	C45 PLASTIC FREEZ LID

CODE	PRODUCT NAME
003111	C45 NAUTIC LOCK PLATE
003114	C45L TOP DR SHELF
050403	C45/C62 DRAIN PAN KIT
003162	C65, C41, C26 DIAL T-STAT EWPC901
003159	C75L/C85 BOTTOM DR SHELF
003164	C75,C60,C85,C115,C130,DP2600 FRIDGE THERMOSTAT
043701	C85 N/T FREEZER DOOR
003140	C110BT FRIDGE DOOR
039989	C110BT S/S SHELF KIT KIT (1 PAIR)
043916	C130 AIRLOCK GLASS SHELF
044402	C130 HINGE
043920	C130 AIRLOCK VEGE BIN
034938	C130L DRAIN TRAY R11263AS
044723	C130L SS FRIDGE DOOR
050518	SLIMLINE 150 FRIDGE SHELF
003175	LED LIGHT ASSY NO LENS
043121	LED LIGHT ASSY INCL LENS
003096	USA62I FREEZER LID
003032	PT2 FRIDGE EVAPORATOR 350MM WIDE X 250MM HIGH
003034	PT4 FRIDGE EVAPORATOR 350MM WIDE X 350MM HIGH
003040	AIR 10 ELECTRONIC THERMOSTAT
003123	USA62IX FLUSH MOUNT SURROUND STAINLESS STEEL
003008	QUICK COUPLINGS ONLY
003011	FRIDGE COMPRESSOR FAN 12V
003156	DOOR UPPER HINGE BRACKET WITH TWO HOLES
003171	PLASTIC RETAINER CLIP
043909	AIRLOCK FRIDGE HANDLE SUIT ALL AIRLOCK MODELS
041493	WIRE SHELF DP150/C115/C130
043090	BRK32PX DOOR WITH PUSH AND TURN LOCK & TURN KEY
044724	DRAW RUNNERS- 60KG WHITE
044690	STEEL LOCK 316 HANDLE
039964	THERMOSTAT FREEZER
003335	FRIDGE SWITCH 25 AMP RATING
051700	VITRI ELECT CONTROL UNIT

DOMETIC SPARE PARTS

CODE	PRODUCT NAME
016580	VENT KIT ALI FLUE AND T-PCE TYPE A
016567	FRIDGE VENT KIT 8 PIECE AS1625 + TP
038725	LOWER FRIDGE VENT KIT NEW STYLE

ICE MAKER SPARE PARTS

CODE	PRODUCT NAME
003151	VITRIFRIGO ICEMAKER PIN FITTING FR
003152	VITRIFRIGO NAUTIC FIT FR ICEMAKER
043449	VITRIFRIGO ICE MAKER MODULE (TIMING)
039598	VITRIFRIGO ICE MAKER MODULE (TIMING)
034816	VITRIFRIGO ICE TRAY/BIN CLEAR
038398	VITRIFRIGO ICEMAKER 110V C/BOARD
038399	VITRIFRIGO ICEMAKER 240V C/BOARD
038403	VITRIFRIGO ICEMAKER INLET HOSE
038397	VITRIFRIGO ICEMAKER 110V FAN
041086	ICEMAKER IMXT HYD PFT TD FAN & BLOWER ASSEMBLY
039966	CL220V CONTACTS SPARE PARTS FOR ICEMAKER

MICROWAVES



CAMEC MICROWAVE 25LT 900W

041439

Designed with the RV market in mind, our microwave features a large mirror finish door that is an ideal match for modern RVs and cookers with mirror top lids.

FEATURES

- Auto Cook with 8 pre-set common food settings
- Stylish design to suit RVs
- 5 selectable power levels
- Easy defrost mode

SPECIFICATIONS

- Dimensions: 483mm(w) x 281mm(h) x 399mm(d)
- Weight: 14.8kg
- 900W output/1400W input
- 240V operation

MICROWAVE SPARE PARTS

CODE	PRODUCT NAME
043520	CAMEC MICROWAVE GLASS TRAY



CAMEC MICROWAVE 20LT 700W BLACK

044431

Compact design microwave with easy to read LCD display and simple operation so you can be cooking in no time! Includes 5 power levels, preset mode - allows you to program the microwave to start at a later time, one touch Quick Start cooking, auto defrost, auto cook modes make cooking or heating common items quick and easy. Simply select the food type then select either the weight or quantity to start. Cooking/heating modes include: Milk/coffee, rice, spaghetti, potatoes, auto reheat, fish, pizza and popcorn.

FEATURES

- Latest design
- Digital control
- 8 Auto Cook modes
- Clock
- Blue LCD display
- Quick Start cooking
- Auto Defrost
- Delayed start cooking
- Multi stage cooking
- Child lock
- 12 month warranty

SPECIFICATIONS

- Dimensions: 452mm(w) x 262mm(h) x 333mm(d)
- Weight 10.5kg
- 700W output/1200W input
- 240V operation

RANGE HOODS



CAMEC RANGE HOOD 12V 2-SPEED

040864

Stainless Steel finish with twin turbo extraction fans and dual low energy LED down lights. Also features a removable filter for easy cleaning and illuminated touch controls. Venting is rear or roof selectable and an optional 50mm venting adaptor (041132) is also available if a venting hose is required.

FEATURES

- Illuminated control buttons
- Powerful 12V turbo 2 speed twin extractor fans
- Convenient roof or rear air venting
- Removable filter for easy cleaning and replacement.

SPECIFICATIONS

- 2 low energy LED down lights
- Dimension: 586mm(l) x 305mm(w) x 60mm(h)



FLUSH MOUNT RANGE HOOD 12V

040865

FEATURES

- Twin turbo fans
- LED strips

SPECIFICATIONS

- Side or rear air venting
- Removable filter for cleaning
- Stainless steel construction
- Includes outlet adaptor and 0.5m flexible duct hose
- Mounting cavity: 465(w) x 187(d) x 53(h)
- External body: 518(w) x 228(d) x 16(h)



RANGE HOOD SPARE PARTS

CODE	PRODUCT NAME
041755	REPLACEMENT FILTER TO SUIT CAMEC 12V RANGE HOOD (REFER CODE 040864)
041754	REPLACEMENT FRONT STICKER TO SUIT CAMEC 12V RANGE HOOD (REFER TO CODE 040684)
041751	REPLACEMENT LED DOWN LIGHT LONG LEAD TO SUIT CAMEC 12V RANGE HOOD (REFER CODE 040864)
041762	REPLACEMENT LED DOWN LIGHT SHORT LEAD (PCB SIDE) TO SUIT CAMEC 12V RANGE HOOD (REFER CODE 040864)
041752	CIRCUIT BOARD CAMEC 12V 2SPEED
044467	REPLACEMENT CIRCUIT BOARD TO SUIT CAMEC 12V RANGE HOOD (REFER CODE 040865 & 040864)
041753	REPLACEMENT SWITCH PANEL TO SUIT CAMEC 12V RANGE HOOD (REFER CODE 040864)
041477	REPLACEMENT FAN TO SUIT CAMEC 12V RANGE HOOD (REFER CODE 040864)
043903	DUCT HOSE 0.5M SUIT 040865
043902	FILTER REMOVABLE SUIT 040865
043899	LED STRIP LEFT SUIT 040865
043900	LED STRIP RIGHT SUIT 040865
042359	CAMEC R/HOOD DUCT TUBE BLACK



OUTLET ADAPTOR TO SUIT CAMEC 040864

041132

Outlet Adaptor for Camec 12V Range hood (refer code 040864). Allows duct tubing to connect to the back of the rangehood.

FEATURES

- Each side measures 95mm x 50mm
- Tube is 42mm O.D. and 32mm I.D
- Tube protrusion 22mm

STOVES



LIDO JNR 2 BURNER & GRILL FLAME ARRESTOR

040326

Suitable for indoor use in caravans and motorhomes. Can also be used for camper trailer and outdoor kitchens

FEATURES

- 2 burner and grill
- Flame arrest on all burners
- Stainless steel body with painted base and hinged lid
- Hose and regulator required

SPECIFICATIONS

- Dimensions: 500mm(w) x 170mm(h) x 280mm(d) + gas fitting
- Weight: 3.6kg

STOVE SPARE PARTS

CODE	PRODUCT NAME
044086	LIDO COOKER LID

WASHING MACHINES



COMPACT RV 2.5KG WASHING MACHINE

041133

Ideal for caravans and motorhomes, this easy to use fully automatic RV washing machine offers washing convenience wherever your travels take you. Featuring simple controls and flexible washing modes, you have the convenience of washing when you want.

FEATURES

- Economical cold water washing
- Blue LED display with wash time remaining function
- 7 washing program combinations including Quick Wash
- High and low water level adjustment for large and small loads

SPECIFICATIONS

- 240V operation
- Dimensions: 410mm(w) x 640mm(h) x 420mm(d)
- Water Usage: Approx 15Lt on low and 20Lt on high
- Weight: 16kg
- Spin cycle speed: 900 RPM



COMPACT RV 3KG WASHING MACHINE

044131

Our latest top load washing machine features a larger 3kg washing capacity and is the only machine in its class to offer an optional hot wash cycle using cold water (this feature adds approximately 20-40 min to the cycle time). And our exclusive LED drum light will help you find that missing sock!

FEATURES

- Economical cold water washing with hot wash option
- Blue LED display with wash time remaining function
- 6 washing program combinations
- High and low water level adjustment for large and small loads
- Precision stainless steel wash tub
- Clothes basket doubles as a tub stabiliser
- LED drum light
- Securing strap and basket included

SPECIFICATIONS

- 240V operation
- Power consumption: 235W (cold) 1035W (hot)
- Load capacity 3.0kg
- Dimensions: 410mm(w) x 740mm(h) x 420mm(d)
- Water Usage: Approx 20Lt on low and 26Lt on high
- Weight: 18kg
- Spin cycle speed: 900 RPM



COMPACT RV 4KG FRONT LOAD 042308

With a large 4kg capacity for its size, you can now enjoy all of the features and wash modes you are accustomed to with your home machine, right in your RV. Requiring only a cold water supply, hot water washing is possible using the machine's in-built heater element.

FEATURES

- 15 wash programs including 3 quick wash modes (14, 30 and 59 min)
- 400-1000 RPM spin speed (adjustable)
- Special AQUAPLUS "delicate skin" wash mode
- Auto water level control
- Delayed start option
- Bi-directional wash selector knob
- Wash time remaining display

SPECIFICATIONS

- 240V operation
- Weight: 47kg
- Dimensions: 510mm(w) x 430mm(d) x 700mm(h)
- Water Usage: Min 19L, max 45L depending on load size and wash cycle
- 1300W max power consumption (hot wash)
- 230W power consumption (cold wash)
- 12 month warranty



WALLMOUNT 2.5KG WASHING MACHINE

050122

The Camec Wall Mount Washing Machine combines elegant design, amazing efficiency and light weight with compact size to provide a class leading solution to space restrictions in your caravan or RV. Rigorous vibration testing has been conducted to ensure years of trouble free operation.

FEATURES

- Illuminated touch screen operation
- Cotton wash
- Quick Wash
- Heated Wash (95°C)
- Drum Cleaning
- Rinse + Spin function
- Delay Function
- Child Lock
- Temperature Control

SPECIFICATIONS

- Rated Voltage 220V
- Rated frequency 50Hz
- Tap water pressure 0.05Pa-0.8MPa
- Water Consumption 20 Lt per wash cycle
- Net weight 24kg
- Spin speed 700 RPM
- External dimensions 575mm(w) x 670mm(h) x 348 mm(d)



CAMEC COMPACT 3.2KG RV DRYER

041834

Ideal for caravans and motorhomes, this compact RV Dryer offers drying convenience wherever your travels take you. Featuring simple operation, it is the perfect partner for the Camec 4kg front load washing machine.

FEATURES

- Specially designed to be mounted upside down if required providing the option of a left or right hand hinged door
- Low maintenance with easy to clean filters
- 850W 240V operation
- Rear venting with universal RV duct kit included

SPECIFICATIONS

- Dimensions: 495mm(w) x 580mm(h) x 410mm(d)
- Weight: 17kg
- Voltage: 220-240V, 50/60Hz

WASHING MACHINE SPARE PARTS

CODE	PRODUCT NAME
044673	CAMEC 3KG WASHER PCB BOARD
041921	CAMEC WASHER SPARE BASKET
041922	CAMEC WASHER SPARE LID INCL
041923	CAMEC WASHER SPARE INLET HOSE
041906	CAMEC 2.5KG WASHER PCB BOARD
041907	CAMEC WASHER SPARE SPIN SENSOR
041908	CAMEC WASHER SPARE WATER LEVEL
041909	CAMEC WASHER SPARE MOTOR
041911	CAMEC WASHER SPARE MODE SWITCH
041912	CAMEC WASHER SPARE WATER
041913	CAMEC WASHER SPARE DRAIN PUMP
041914	CAMEC WASHER SPARE V-BELT
041915	CAMEC WASHER SPARE LID SPRING
042796	CAMEC WASHER SPARE HOSE CLAMP
042798	CAMEC WASHER SPARE DRAIN HOSE
042797	CAMEC WASHER SPARE PUMP HOSE
041918	CAMEC WASHER SPARE AIR TRAP
041919	CAMEC WASHER MOTOR PULLEY
041920	CAMEC WASHER SPARE MOUNTING
041928	CAMEC WASHER SPARE BASE COVER
051181	FAN BELT FOR 3.2KG RV DRYER
043537	CAMEC F/L WASHER MOTOR
043538	CAMEC F/L WASHER DOOR LOCK
043539	CAMEC F/L WASHER DOOR SEAL
043540	CAMEC F/L WASHER SUMP/DRAIN
043541	CAMEC F/L WASHER TUB HOSE
043542	CAMEC F/L WASHER HEAT ELEMENT
043543	CAMEC F/L WASHER PULLEY
043544	CAMEC F/L WASHER BELT
043545	CAMEC F/L WASHER PCB
043546	CAMEC F/L WASHER FILTER COVER
043529	CAMEC F/L WASHER DRAIN HOSE
043547	CAMEC F/L WASHER PUMP
043548	CAMEC F/L WASHER SPRING LEFT
043549	CAMEC F/L WASHER SPRING RIGHT
043550	CAMEC F/L WASHER HINGE ASSY
043551	CAMEC F/L WASHER DISP DRAW
043530	CAMEC F/L WASHER DAMPER ASSY
043531	CAMEC F/L WASHER CONTROL KNOB
043532	CAMEC F/L WASHER CONTROL PANEL
043533	CAMEC F/L WASHER DOOR FRAME
043534	CAMEC F/L WASHER FOOT ASSEMBLY
043535	CAMEC F/L WASHER INLET VALVE
043536	CAMEC F/L WASHER PRESS SWITCH
051298	PORTHOLE DOOR COMPLETE 042308
051182	TIMER FOR 3.2KG RV DRYER

WALL MOUNT WASHING MACHINE SPARE PARTS

CODE	PRODUCT NAME
050635	ASSY-DOOR-SAFETY
050644	DISPLAY BOARD
050645	LAMP COVER
050646	HINGE-WIRING HARNESS COVER
050647	LAMP SPONGE
050648	SEALING STRIP
050649	SEALING STRIP
050650	DOOR-GLASS
050651	LEVER-DOOR
050652	LEVER-PIN
050653	SPRING-LEVER
050636	GASKET
050654	HOLDER-GLASS
050655	CUSHION
050656	SPONGE
050657	BELT
050658	FRONT CASE
050659	DOOR-DIAPHRAGM
050660	TURBIDITY SENSOR
050661	TUB-FRONT
050662	PACKING-TUB
050663	DRUM-FRONT
050637	COVER-DOOR
050664	DOOR-LOCK S/W
050665	DRUM-LIFTER
050666	DRUM-WRAPPER
050667	DRUM-BACK
050668	ASSY-FLANGE SHAFT
050669	TURBIDITY SENSOR
050670	FILTER-EMI
050671	ASSY-JOINT AIR
050672	AIR TUBE ASSY
050673	REAR CASE LEFT
050638	COVER-DOOR GASKET
050674	HEATER
050675	SEAL-OIL
050676	BEARING-BALL
050677	BEARING-BALL

CODE	PRODUCT NAME
050678	TUB-BACK
050679	ASSY-M.WIRE HARNESS
050680	ASSY POWER CORD
050681	MOTOR(STATOR)
050682	MOTOR(ROTOR)
050683	ASSY-BOLT
050639	SCREW
050684	GASKET
050685	RESILIENT GASKET
050686	NUT
050687	REAR CASE RIGHT
050688	CABLE CHANNEL
050689	BRACKET-HEATER
050690	WATER SHIELD
050691	ASSY PCB PARTS
050692	PACKING-TUB
050693	ASSY DRAIN VALVE
050640	GUIDE-HINGE
050694	INVERTER PLATE ASSY
050695	EARTHING GASKET
050696	SENSOR PRESSURE
050697	RETRACTOR
050698	VALVE-WATER
050699	SPEAKER
050700	LEAD FELT
050701	ASSY INLET HOSE
050702	BOLT TAB
050703	DAMPER RUBBER
050641	HINGE-DOOR
050704	JAW
050705	INSTALLATION FRAME
050706	CUSHION RUBBER PAD
050707	HOSE-DRAWER
050708	BAND-RING
050709	BIG 3WAY VALVE
050642	WIRING HARNESS
050643	DISPLAY BOARD COVER



ELECTRICAL

- Auto Lights 81
- Batteries 89
- Solar..... 91
- Connectors, Sockets & Switches 93
- Globes & Fuses 99
- Interior & Exterior Lighting 102
- Power 12V 106
- Power 240V..... 108
- Generators 110
- Wiring 111
- Chargers & Inverters 112

AUTO LIGHTS



LED RED AMBER SIDE MARK LIGHT

004671

Red/amber marker with 2 red & 2 amber LEDs.

SPECIFICATIONS

- Dimensions: 58mm(l) x 19mm(h) x 35mm(d)



REFLECTOR STICK ON 22 X 85

038317 AMBER

038316 CLEAR

038318 RED

FEATURES

- ADR approved

SPECIFICATIONS

- Dimensions: 85mm(l) x 22mm(w)
- Sold individually



AUTO LIGHT NUMBER PLATE

035774

SPECIFICATIONS

- Dimensions: 68mm(w) x 38mm(h) 60mm(d)



FRONT MARKER LAMP CLEAR

004681

Front & outline marker & front position.

SPECIFICATIONS

- Dimensions: 101mm(l) x 28mm(h) x 52mm(w)
- Globes not included



NARVA STICK ON REFLECTOR

035354 CLEAR

035340 AMBER

035337 RED

Retro reflector, ADR approved.

SPECIFICATIONS

- Dimensions: 105mm(l) x 55mm(w)
- Sold individually



SIDE MARKER LAMP

004658

Red/amber auto side clearance lamp.

SPECIFICATIONS

- Dimensions: 130mm(l) x 60mm(w) x 40mm(h)



REAR MARKER LAMP RED

004686

FEATURES

Rear end outline marker & front position (side) lamp. Red lens

SPECIFICATIONS

- Dimensions: 101mm(l) x 52mm(w) x 28mm(h)



REFLECTOR SCREW ON

004958 RED

004959 CLEAR

004960 AMBER

Featuring a high impact PMMA lens, these reflectors are fully ADR compliant.

SPECIFICATIONS

- Dimensions: 75mm(l) x 46mm(w)

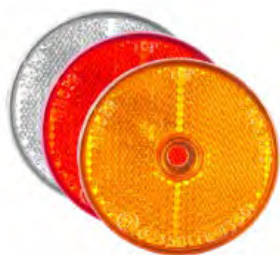

REFLEX REFLECTOR LENS

- 051046 AMBER**
- 051047 RED**
- 051048 CLEAR**

Reflex Series reflex reflectors are constructed from high quality optic prisms resulting in a highly reflective lens for maximum compliance and safety. The Reflex series is a midsize reflex reflector with increased reflective surface area ensuring compliance of front, side and rear applications to medium sized vehicles and trailers. These units feature a high impact PMMA lens and ultrasonically welded base with integral screw mounts for easy and secure fitting and flush finish.

FEATURES

- High grade optic prisms
- Ultrasonic welded base
- High impact lens
- Screw mount base
- Fully ADR compliant

SPECIFICATIONS

- Applications: Trucks, Rigid Bodies, Bus & Coach, Trailers, Custom Builds
- Functions: Front / Side / Rear Reflex Reflector
- Mounting: Screw mount
- Materials: High impact PMMA lens, ABS base
- Environmental: Fully Sealed
- Dimensions: 60mm diameter x 8mm (h)

REFLEX REFLECTORS

- 051043 AMBER**
- 051044 RED**
- 051045 CLEAR**

The Reflex series reflectors are constructed from high quality optic prisms resulting in a highly reflective lens for maximum compliance and safety. The Reflex series feature low profile dimensions while remaining fully compliant for front, side and rear applications providing a durable and versatile reflex reflector package. These units feature a high impact PMMA lens and ultrasonically welded screw mount base for easy and secure fitting.

FEATURES

- High grade optic prisms
- Ultrasonic welded base
- High impact lens
- Screw mount base
- Fully ADR compliant

SPECIFICATIONS

- Applications: Trucks, Rigid Bodies, Bus & Coach, Trailers, Custom Builds
- Functions: Front / Side / Rear Reflex Reflector
- Mounting: Screw mount
- Materials: High impact PMMA lens, ABS base
- Environmental: Fully Sealed
- Dimensions: 92 x 24 x 7.5mm



LICENCE PLATE LAMP NARVA

004697

SPECIFICATIONS

- Dimensions: 107mm(l) x 42mm(w) x 37mm(h)
- Require 2 x 4W BA9S globes



LICENCE PLATE LAMP NARVA

004698

SPECIFICATIONS

- Dimensions: 105mm(w) x 54mm(h) x 49mm(d)



LED LICENCE PLATE LAMP

004702

Lamp with black bracket.

SPECIFICATIONS

- Dimensions: 76mm(w) x 42mm(h) x 30mm(d)
- Multivolt 12/24



LED COURTESY / FOOTWELL LIGHT

051056

SPECIFICATIONS

- 10V - 30V
- Surface mount: 52 x 30 x 16 x 38



LED LICENCE PLATE LAMP WHITE

043962

SPECIFICATIONS

- Revolutionary Design
- Saves Time on Installation
- ECE approved
- IP67 100% Water proof
- Voltage Range 12-24 Volt
- 5 Year Warranty
- 60mm x 22mm x 22mm



ARK RECTANGULAR LED COMBO SET

044649

FEATURES

- Connected to 0.5m of cable
- Left and right side
- Dimensions: 150mm x 80mm
- Tested to water depths of 15m
- ADR approved



COMBO LAMP STOP/TAIL/ INDICATOR

004735

Rear combination direction indicator & stop/ tail lamp with in-built reflex reflector.

SPECIFICATIONS

- 400 x 127 mm
- 12V



ARK SLIMLINE LED COMBO SET

044648

5 Functions. Includes licence plate lamp.

FEATURES

- Dimensions: 100mm x 90mm
- Stop/tail, indicator, built-in reflex reflector
- 100% submersible
- Polycarbonate lens
- Prewired and mounting screws
- Complies to ADR
- 100,000 hours of operation



ARK LED LIGHT BOARD

044650 1.5M

The Ark LED Trailer Light Boards come complete with ultra-thin LED lights and all 3 main trailer plugs for flexibility and multipurpose use across several vehicles: 7 pin flat, 7 pin small round and 7 pin large round.

Simply choose the appropriate trailer plug to suit your vehicle, then with a simple click, the Trailer Light Board is ready for use and away you go. Each comes with 8m of cable moulded to the innovative interchangeable socket.

LICENCE PLATE LED WITH WIDE OPTICS

051042

This is a modern LED version of similar style conventional lamps. The license plate has an innovative body mounting system making it a simple retrofit or for easy OEM production. Featuring six LEDs and wide angle optics, this light has Emark approval making it well suited for both trailer and vehicle applications.

FEATURES

- Wide angle optics
- Classic design now in LED
- Unique mounting system for easy and quick mounting
- Fully ADR compliant

SPECIFICATIONS

- Applications: Trucks, Heavy Trailers, Trailers, RV
- Functions: License Plate
- Voltage: 9-33V DC Varivolt®
- Wattage: 1.0W
- Mounting: Surface Mount with Screw Cap

- Materials: Polycarbonate Lens ABS Body
- Environmental: IP67 Hermetically Sealed
- Cable Length: 0.5M
- Dimensions: 105 x 48 x 37.5mm





HD AMBER LED MARKER LAMP

- 051029 AMBER ONLY
- 044153 SIDE RED/AMBER SIDE MARKER

13 Series LED lamps are a large profile marker designed for high visibility featuring intelligent angled optics to provide maximum safety and compliance while matching modern vehicle style. Simple surface mount design allows for fast and easy fitting in production environments. The dimensional design allows for a retrofit or upgrade of similar style lamps with mounting points supporting direct replacement. Suited to OE and commercial applications.

FEATURES

- High visibility marker solution
- Intelligent optics for maximum safety and compliance
- Fast and secure surface mounting system
- Direct LED replacement for similar style lamps
- Fully ADR compliant

SPECIFICATIONS

- Applications: Trucks, Rigid Bodies, Bus & Coach, Trailers, Custom Builds
- Functions: Side Marker
- Voltage: 9-33V DC Varivolt®
- Wattage: 0.5W
- Mounting: Surface Mount
- Materials: High Impact PMMA Lens ABS Body
- Environmental: IP67 Hermetically Sealed
- Cable Length: 0.5M
- Dimensions: 120 x 64 x 32mm
- ADR Compliance
- Side Marker: 45/01



COMPACT LED MARKER SM62 SERIES

- 051034 RED/AMBER
- 051035 AMBER
- 051036 RED
- 051037 CLEAR

The Compact LED Marker series is a low profile LED marker with a highly contoured design for seamless integration with modern vehicle styles. Designed for reliability and performance this range of markers provides ADR compliant solutions for front end outline, rear position, supplementary indicator and side marker functions. Can be fitted easily where space is limited. With slimline smart clip mounting, the clip base is invisible when the lamp is installed which makes a perfect lamp to vehicle match and professional finish.

FEATURES

- Low profile LED marker
- Highly aesthetic optics
- Slimline design
- Invisible Smart Clip™ mounting
- Fully ADR compliant

SPECIFICATIONS

- Applications: Trucks, Rigid Bodies, Buses & Coaches, Trailers, Custom Builds
- Functions: Side Marker - Red / Amber, Amber
- Clearance Marker - Clear, Red
- Voltage: 9-33V DC Varivolt®
- Wattage: 0.4W - all functions
- Mounting: Invisible Smart Clip™
- Materials: Polycarbonate Lens ABS Body
- Environmental: IP67 Hermetically Sealed
- Cable Length: 0.5M Standard
- Dimensions: 57 x 35 x 21mm



LED MARKER LAMPS SM65 SERIES

- 051038 RED/AMBER
- 051039 RED LED
- 051040 AMBER LED
- 051041 CLEAR LED

65 LED series markers are designed for applications where high performance and reliability is required. With wide angle optics and extended base design, this series delivers maximum visibility in applications where multiple markers are installed.

Providing a compliant solution for front end outline, rear position, supplementary indicator and side marker functions. These markers also feature a robust Smartclip™ base which is contoured to protect the main lens and LED module from extreme conditions.

The 65 LED series is built for heavy duty use and suited to OEM and commercial vehicle applications & renovators.

FEATURES

- Heavy duty LED marker
- High visibility design
- Protective base
- Smart Clip™ mounting
- Fully ADR compliant

SPECIFICATIONS

- Applications: Trucks, Rigid Bodies, Buses & Coaches, Trailers, Custom Builds
- Functions: Front Clearance Marker
- Side Marker
- Rear Position
- Voltage: 9-33V DC Varivolt®
- Wattage: 0.4W - all functions
- Mounting: Smart Clip™
- Materials: Polycarbonate Lens ABS Body
- Environmental: IP67 Hermetically Sealed
- Cable Length: 0.5M Standard
- Dimensions: 60 x 38 x 32mm



LED MARKER LAMPS 60 SERIES

- 051031 RED**
- 051032 AMBER**
- 051033 CLEAR**

The Perei 60 Series LED lamps are a versatile heavy duty marker designed for performance and reliability. The 60 series provides a complete styled marker solution for forward, side and rear marker / repeater functions and feature intelligent angled optics providing maximum safety and compliance while matching modern vehicle style. The low profile compact design allows for a wide range of fitting applications where space is limited. An innovative mounting system uses Smart Clip™ module and base design for secure fitting. Suited to OEM and commercial applications.

FEATURES

- Heavy duty marker solution
- Intelligent optics for maximum safety and compliance
- Secure Smart Clip™ mounting
- Fully ADR compliant

SPECIFICATIONS

- Applications: Trucks, Rigid Bodies, Bus & Coach, Trailers, Custom Builds
- Functions: Front End Outline
- Side Marker - Exterior Cabin
- Side Marker: Rear Position
- ABS Warning
- Voltage: 9-33V DC Varivolt®
- Wattage: All Functions: 0.36W @12V
- Mounting: Smart Clip™
- Materials: High Impact PMMA Lens ABS Body
- Environmental: IP67 Hermetically Sealed
- Cable Length: 3.0M
- Dimensions: 70 x 41 x 23mm



LED MARKER LAMPS SM8 SERIES

- 051028 SIDE MARKER AMBER**
- 044151 FRONT MARKER WHITE**
- 044152 REAR MARKER RED**

The new SM8 LED Series markers are designed for the direct replacement of it's previous incandescent models. The SM8 series is made for heavy duty use which features a high impact acrylic lens and strong ABS base, and is suited to OEM and commercial vehicle applications.

Perfect for upgrading existing incandescent versions to LED.

FEATURES

- 9-33 Volt DC integrated circuitry
- Clip mount
- Retro-fit same incandescent style lamp series
- 0.5m Cable
- Fully ADR compliant

SPECIFICATIONS

- Applications: Caravans, Trailers, Boat trailers, Light trucks
- Voltage: 9-33V DC Varivolt®
- Functions: Front Clearance Marker: Clear
- Side Marker: Amber
- Rear Position Marker: Red
- Wattage: 0.8W - all functions
- Mounting: Clip mount
- Materials: High impact acrylic lens
- Environmental: IP67 Hermetically Sealed
- Cable Length: 0.5M Standard
- Dimensions: 90 x 50 x 22mm



LED COMBO LAMP 9 - 33V 0.5 LEAD 190 SERIES

051008

Featuring free form optics in a smart slim line design the CRL190LED series are robust multifunction lamps that can be mounted in areas where space is limited. The lamps use Varivolt® 10-30V circuit technology and incorporate stop, tail, indicator, reverse and reflector functions providing an all in one solution. The high output SMD LED technology together with the smart optic design enables these lamps to comply with all the above functions with their slim line dimensions. Excellent for mine bars, trailer / ute lamps or commercial / industrial applications.

FEATURES

- Slim line design - multifunction
- Free form optics
- Surface mounting
- Retrofit applications
- Fully ADR compliant

SPECIFICATIONS

- Applications: Minebars, Vehicles, Forklifts, Light Trucks, Trucks
- Functions: Stop / Rear Position / Direction Indicator / Reverse / Reflector
- Voltage: 9-33V DC Varivolt®
- Wattage
 - Rear Direction: 1.5W@12V
 - Rear Position: 0.5W@12V
 - Stop Lamp: 2.5W@12V
 - Reverse: 2.0W@12V
- Mounting: Surface Mount
- Materials: Polycarbonate Lens ABS Body
- Environmental: IP67 Hermetically Sealed
- Cable Length: 0.4M Standard
- Dimensions: 191 x 49 x 28mm
- Sold singly



COMBINATION LED TAIL LAMP 280 SERIES

051009

The Combination LED Tail Lamp is the next generation in multifunction rear combination signal lamps. Delivering highly styled optics and unique lens design, this lamp provides a fully compliant rear lighting solution for stop, rear position, direction indicator, reverse and reflector functions. Constructed with a polycarbonate lens and heavy duty smart clip base with multiple mounting points, the CRL280 LED series is designed for high reliability and performance and well suited to OEM and commercial vehicle applications.

FEATURES

- Full function LED combination lamp
- Highly styled optical design
- All in one solution for rear lighting
- Heavy duty Smart Clip™ base
- Fully ADR compliant

SPECIFICATIONS

- Applications: Trucks, Rigid Bodies, Buses & Coaches, Trailers, Custom Builds
- Functions: Stop / Rear Position / Direction Indicator / Reverse / Reflector
- Voltage: 9-33V DC Varivolt®
- Wattage
 - Stop Lamp: 3W
 - Rear Position: 0.5W
 - Direction Indicator: 3W
 - Reverse: 2.5W
- Mounting: Heavy duty Smart Clip™ base
- Materials: Polycarbonate Lens ABS Body
- Environmental: IP67 Hermetically Sealed
- Cable Length: 0.5M
- Dimensions: 284 x 100 x 37mm
- Sold singly



SLIMLINE COMBO LED LAMP 360 SERIES

051022 STOP/TAIL/INDICATOR - BLACK BASE

051023 STOP/TAIL/INDICATOR - CHROME BASE

051024 STOP/TAIL/REVERSE - BLACK BASE

051025 STOP/TAIL/REVERSE - CHROME BASE

051026 STOP/TAIL ONLY - BLACK BASE

051027 STOP/TAIL ONLY - CHROME BASE

Designed with a smart and modern slimline look, the Slimline Combo LED Lamps are a robust multifunction lamp that can be mounted in areas where space is limited.

Featured 10 - 33 Varivolt® DC integrated circuitry technology, incorporating stop, tail, indicator and reverse functions providing an all in one rear signal solution.

The Series is fully ADR compliant, making it the complete package, perfectly suited to OEM and commercial vehicle applications.

FEATURES

- Slim line design - multifunctions
- 10 - 30 Varivolt
- Surface mounting
- Available in Black or Chrome Base
- Fully ADR compliant

SPECIFICATIONS

- Applications: Caravans & RV, Light Trucks & Trailers, Utes, Custom Builds
- Functions: Stop / Tail / Indicator / Reverse Functions
- Voltage: 10-30V DC Varivolt®
- Wattage: Stop: 3W / Tail: 0.3W / Indicator: 1.5W / Reverse: 1.5W
- Mounting: Surface mount, Screw on
- Materials: Polycarbonate Lens ABS Body
- Environmental: IP67 Hermetically Sealed
- Cable Length: 0.5M
- Dimensions: 400 x 46 x 17mm - single lights
- Dimensions: 400 x 82 x 17mm - combination lights



TWIN COMBINATION LED HEAVY DUTY 405 SERIES

051010

The Twin Combination LED lamp deliver quality, performance and durability for heavy duty applications. Featuring high visibility optics and modular design, the lamp can be customised to suit stop / rear position / direction indicator and reverse functions as required. Each module also incorporates an integrated reflector providing a complete compliant rear signalling solution. Constructed with ultra strong polycarbonate lenses with enhanced chemical protection, high reliability optics and toughened ABS base the heavy duty lamp series is designed to handle the toughest of conditions under constant operation. Suited to OEM and commercial vehicle applications.

FEATURES

- Heavy duty rear Jumbo lamp
- Modular design with security caps
- Integrated reflectors
- Slimline profile
- Fully ADR compliant

SPECIFICATIONS

- Applications: Trucks, Rigid Bodies, Buses & Coaches, Trailers, Custom Builds
- Functions: Stop / Rear Position / Direction Indicator / Reflector
- Voltage: 9-33V DC Varivolt®
- Wattage
 - Stop: 3W
 - Rear Position: 0.4W
 - Indicator: 3W
- Mounting: Rear Bolt Mount
- Materials: Polycarbonate Lens ABS Body / Modular heavy duty ABS base
- Environmental: IP67
- Cable Length: 0.5M
- Dimensions: 405 x 131 x 40mm
- Black base
- Sold singly



TRIPLE COMBINATION LED HEAVY DUTY 605 SERIES

051011 STOP / TAIL / INDICATOR

051012 STOP / TAIL / INDICATOR / REVERSE

The Triple Combination LED Heavy Duty lamps deliver quality, performance and durability for heavy duty applications. Featuring high visibility optics and modular design, the series can be customised to suit stop / rear position / direction indicator and reverse functions as required. Each module also incorporates an integrated reflector providing a complete compliant rear signalling solution. Constructed with ultra strong polycarbonate lenses with enhanced chemical protection, high reliability optics and toughened ABS base the LED series is designed to handle the toughest of conditions under constant operation. Suited to OEM and commercial vehicle applications.

FEATURES

- Heavy duty rear Jumbo lamp
- Modular design with security caps
- Integrated reflectors
- Slimline profile
- Fully ADR compliant

SPECIFICATIONS

- Applications: Trucks, Rigid Bodies, Buses & Coaches, Trailers, Custom Builds
- Functions: Stop / Rear Position / Direction Indicator / Reflector
- Voltage: 9-33V DC Varivolt®
- Wattage
 - Stop: 3W
 - Rear Position: 0.4W
 - Indicator: 3W
 - Reverse: 2.5W
- Mounting: Rear Bolt Mount
- Materials: Polycarbonate Lens ABS Body / Modular heavy duty ABS base
- Environmental: IP67
- Cable Length: 0.5M
- Dimensions: 601 x 131 x 42mm
- Black base
- Sold singly



LED COMBO TRAILER LAMP LH/RH 120 SERIES

051004

The Trailer Lamp is a durable combination LED lamp designed to provide an all in one solution for rear lighting signaling applications. Featuring 12 high reliability LEDs the advanced optics provide full form signal illumination™ for increased safety and awareness. The low profile body makes this lamp a perfect fit for many OE and retrofit applications.

FEATURES

- 12 LED FFSI™ technology
- Low profile dimensions to suit multiple applications
- Simple quick mounting design
- Integrated reflex reflector
- E Marked

SPECIFICATIONS

- Applications: Trailers, Boat Trailers, Caravans, Light Trucks
- Functions: Stop / Tail / Indicator / Reflector
- Voltage: 10-30V DC Varivolt® Wattage:
 - Rear Direction: 1.5W@12V
 - Rear Position: 0.25W@12V
 - Stop Lamp: 1.5W@12V
- Mounting: Stud Mount
- Materials: High Impact PMMA Lens ABS Body
- Environmental: IP67 Hermetically Sealed
- Cable Length: 0.5M
- Dimensions: 150 x 80 x 30mm
- Sold as a pair (L/H & R/H)

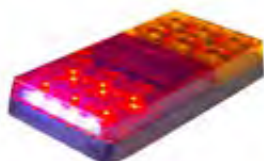



LED COMBO TRAILER LAMP LH/RH 20 SERIES

051005

The LED Combo Trailer Lamp is the next advancement in automotive LED lighting technology. Incorporating stop / tail / indicator / lic plate and reflector functions for an all in one package. This modern design with unique lens pattern, produces a high quality finish for rear lighting requirements.

The low profile body makes this lamp a perfect fit for many OE and retro-fit applications.

FEATURES

- Highly aesthetic lens design
- Low profile dimensions to suit multiple applications
- Simple quick mounting design
- Integrated reflex reflector
- Fully ADR compliant

SPECIFICATIONS

- Applications: Minebars, Vehicles, Forklifts, Light Trucks, Trucks
- Functions: Stop / Tail / Indicator / License plate (on one) / Reflector
- Voltage: 9-33V DC Varivolt®
- Wattage:
 - Rear Direction: 1.0W@12V
 - Rear Position: 0.2W@12V
 - Stop Lamp: 1.0W@12V
 - License Plate: 0.6W@12V
- Mounting: Surface mount
- Materials: Polycarbonate Lens ABS Body
- Environmental: IP67 Hermetically Sealed
- Cable Length: 0.5M Standard
- Dimensions: 100 x 100 x 30mm
- Sold as a pair (L/H & R/H)



LED COMBO LAMP 10-30V 9M LEAD 14 SERIES

051006 LEFT HAND

051007 RIGHT HAND WITH LICENSE PLATE LAMP

The LED Combo Lamp is the next advancement in automotive LED lighting technology. Incorporating stop / tail / indicator and reflector functions all in one package, this modern design and unique lens pattern produces a high quality finish for rear lighting requirements. The low profile body makes this lamp a perfect fit for many OE and retrofit applications.

FEATURES

- Highly aesthetic lens design
- Low profile dimensions to suit multiple applications
- Simple quick mounting design
- Integrated reflex reflector
- Fully ADR compliant

SPECIFICATIONS

- Applications: Trailers, Boat Trailer, Caravans, Light Trucks
- Functions: Stop / Tail / Indicator / License plate (on 051007) / Reflector
- Voltage: 10-30V DC Varivolt®
- Wattage:
 - Rear Direction: 1.2W@12V
 - Rear Position: 0.17W@12V
 - Stop Lamp: 1.2W@12V
- Mounting: Stud mount
- Materials: Polycarbonate Lens ABS Body
- Environmental: IP67 Hermetically Sealed
- Cable Length: 9 meters
- Dimensions: 100 x 100 x 30mm

BATTERIES



CAMEC SEALED LEAD ACID BATTERIES

042885 100AH

043165 120AH

Perfect for use with CAMEC Solar Panels, Sealed Lead Acid (SLA) Absorbed Glass Mat (AGM) batteries are ideal for RV and marine use. They are completely sealed and can be stored at any angle with great vibration resistance, making them ideal for 4 x 4 use as well. The tough and high quality ABS housing will last for decades without aging or deforming keeping your battery in perfect condition. High purity, thick lead-calcium alloy plates ensure a long design lifespan of up to 8 years and the quality copper-silver terminals have a small contact resistance and high corrosion resistance.

FEATURES

- Now 36 month warranty
- 100% sealed
- Maintenance free

SPECIFICATIONS

100AH AGM BATTERY

- Nominal Capacity: 100Ah @ 20hr rate FV(1.75V/cell)
- Operating Temp Range: Charge 0 to 40°C
- Discharge: -20 to 50°C
- Storage: -20 to 40°C
- Dimensions: 306mm(l) x 210mm(h) x 169mm(d)
- Weight: 27.8kg

SPECIFICATIONS

120AH AGM BATTERY

- Nominal Capacity: 120Ah @ 20hr rate FV (1.80V/cell)
- Operating Temp Range: Charge -10°C to 40°C
- Discharge: -20°C to 50°C
- Storage: -20°C to 40°C
- Dimensions: 332mm(l) x 217mm(h) x 172mm(d)
- Weight: 31kg

CAMEC 120AH SLIM AGM BATTERY

044771

FEATURES

- Front terminals make installation, maintenance and supervision easy
- Shield design protects terminals from short circuit
- Unique vent valve design, reducing water loss and prevent air/spark from entering
- 36 month warranty



SPECIFICATIONS

- Nominal voltage: 12v
- Nominal capacity: 120Ah @ 20 hour rate FV (1.8V/cell)
- Approximate weight: 31.0kg (68.34lbs)
- Terminals: (M8 female thread) x2
- Internal resistance: $\leq 3.5 \Omega$ (fully charged)
- Maximum discharge current: 1200A (5 sec)
- Maximum charge current: 25A
- Operating temperature range: Charge: -10°C~40°C (14°F~104°F), Discharge: -20°C~50°C (4°F~122°F), Storage: -15°C~40°C (5°F~104°F)
- Self discharge 3% of capacity declined per month at 25°C
- Dimensions battery: 395mmL x 110mmW x 285mmH
- Dimensions terminal: 16mm dia x 6mmH x 8mm hole dia



BATTERY BOX STANDARD WITH LID & STRAP

000336

High quality, lightweight, black polypropylene, vented battery box impervious to battery acids. Sturdy carry handles, two vents and lid with recesses to allow cable entry. Supplied with webbing tie down strap, screws and securing brackets.

SPECIFICATIONS

- Internal Dimensions: 275mm(l) x 200mm(h) x 180mm(d)



BATTERY BOX LARGE WITH LID & STRAP

000338

High quality, lightweight black polypropylene vented battery box impervious to battery acids. Sturdy carry handles, two vents and lid with recesses to allow cable entry. Supplied with webbing tie down strap, screws and securing brackets.

SPECIFICATIONS

- Internal Dimensions: 375mm(l) x 200mm(h) x 185mm(d)
- Suits 042885 100 A/hr battery or 043165 120 A/hr battery



BATTERY BOX WITH MULTIPLE OUTPUTS

050718

FEATURES

- Strong ABS with flame-retardant rating UL94 V-0
- Multiple port types allow you to connect a range of devices
- Easily connect a DC/DC charger or solar panel to charge the battery, or use a VSR to charge directly from crank battery (not supplied)
- Can be used to jump start vehicles (175A Anderson jumper cable set is an optional extra)
- All ports are recessed into the body to reduce likelihood of damage
- Easily see battery status with large digital display

SPECIFICATIONS

- Materials: ABS UL94 V-0
- Box dimensions: 455mm (l) x 240mm (w) x 330mm (h)
- Max. battery dimensions: 350mm (l) x 175mm (w) x 220mm (h)
- Max. battery weight: 35.0kg
- Max. battery capacity: 130Ah
- Suitable battery types: Deep cycle (Lithium, AGM, Calcium, Wet, Gel)
- Charge method: AC charger, solar panel, DC-DC charger or VSR(optional)
- Ports: 1 x dual USB output, 2 x cigarette plug outputs, 1 x 50A VSR input (optional, black Anderson plug), 3 x 50A Anderson plug inputs/outputs, 1 x 175A Anderson plug output



BATTERY HOLD DOWN CLAMP 7IN

004160



BATTERY BOX STRAP

000337

1372mm long

SOLAR



CAMEC 100W SOLAR PANEL 12V

044045

SPECIFICATIONS

- Dimensions 664 x 1006 x 35mm
- Size of Solar Cell 156 x 156mm
- Max Power Output (Pm) 100 Watt
- Output Tolerance $\pm 5\%$
- Open Circuit Voltage (Voc) 25.5V
- Short Circuit Current (Isc) 6.18A
- Working Current (Imp) 5.81A
- Working Voltage (Vmp) 17.2V
- Type of Output Terminal Junction Box
- Testing Conditions AM1.5, 1000W/m², 25°C
- Weight 7.5kg
- MC4 Plugs No

CAMEC 150W SOLAR PANEL 12V

044046

SPECIFICATIONS

- Dimensions 664 x 1460 x 35mm
- Size of Solar Cell 156x156mm
- Max Power Output (Pm) 150 Watt
- Output Tolerance $\pm 5\%$
- Open Circuit Voltage (Voc) 22.4V
- Short Circuit Current (Isc) 8.66A
- Working Current (Imp) 8.31A
- Working Voltage (Vmp) 18.1V
- Type of Output Terminal Junction Box
- Testing Conditions AM1.5, 1000W/m², 25°C
- Weight 10.6kg
- MC4 Plugs Yes



CAMEC FOLDING SOLAR PANELS WITH EXCLUSIVE 15A REGULATOR - 100 WATT

044047

SPECIFICATIONS

- Dimensions Open: 1052 x 664 x 35mm
- Dimensions Folded: 524 x 644 x 75mm
- Size of Solar Cell: 156 x 156mm
- Max Power Output (Pm): 100 Watt
- Output Tolerance: $\pm 5\%$
- Open Circuit Voltage (Voc): 22.5V
- Short Circuit Current (Isc): 6.18A
- Working Current (Imp): 5.62A
- Working Voltage (Vmp): 17.8V
- Type of Output Terminal: Junction Box
- Testing Conditions: AM1.5, 1000W/m², 25°C
- Weight: 10.0kg



CAMEC FOLDING SOLAR PANELS WITH EXCLUSIVE 15A REGULATOR - 120 WATT

044048

SPECIFICATIONS

- Dimensions Open: 1266 x 664 x 35mm
- Dimensions Folded: 631 x 644 x 75mm
- Size of Solar Cell: 156 x 156mm
- Max Power Output (Pm): 120 Watt
- Output Tolerance: $\pm 5\%$
- Open Circuit Voltage (Voc): 21.60V
- Short Circuit Current (Isc): 7.08A
- Working Current (Imp): 6.8A
- Working Voltage (Vmp): 17.60V
- Type of Output Terminal: Junction Box
- Testing Conditions: AM1.5, 1000W/m², 25°C
- Weight: 12.0kg



CAMEC FOLDING SOLAR PANELS WITH EXCLUSIVE 15A REGULATOR - 160 WATT

044049

SPECIFICATIONS

- Dimensions Open: 1332 x 758 x 35mm
- Dimensions Folded: 664 x 758 x 75mm
- Size of Solar Cell: 156 x 156mm
- Max Power Output (Pm): 160 Watt
- Output Tolerance: $\pm 5\%$
- Open Circuit Voltage (Voc): 22.30V
- Short Circuit Current (Isc): 9.19A
- Working Current (Imp): 8.88A
- Working Voltage (Vmp): 18.0V
- Type of Output Terminal: Junction Box
- Testing Conditions: AM1.5, 1000W/m², 25°C
- Weight: 14.0kg

FEATURES

- All folding solar panels come with a carry bag & strap
- Each panel has approx. 5m power lead with Anderson plug fitted
- Also includes Anderson plug to alligator clips adaptor



SOLAR CHARGE REGULATOR

050731 30A

FEATURES

- Built-in industrial micro controller
- Big LCD display, all adjustable parameter
- Full 3-stage PWM charge management
- Built-in short-circuit protection, open-circuit protection, reverse protection, over-load protection
- Dual MOSFET Reverse current protection, low heat protection

SPECIFICATIONS

- Rated AMP: 30AMP
- Charging Voltage: 14.6V
- Low-Voltage Disconnect: 10.7V
- Low-Voltage Reconnect: 12.6V
- USB Output: 5V/2A
- Standby Lost: <10mA
- Working Temp: -35 +60C
- Size: 133 x 70 x 33mm
- Weight: 150g



SOLAR JUNCTION BOX DOUBLE

050990

Usually, at some point the solar power cables need to enter into the caravan or boat and down to the battery area. To avoid making unsightly and potentially leaky cable entries, you can use this neat product and drill out your cable entry point, and then cover it over giving you two fully waterproof gland cable entries that look neat and purpose built. IP67 cable glands included.

SPECIFICATIONS

- Length: 120mm
- Width: 90mm
- Height: 40mm
- Mounting Method: Screw Down Bracket



SOLAR CHARGE REGULATOR 15 AMP

042470

Solar Charge Regulators are able to handle charge and discharge from a 12V battery and provide over-charging/discharging, and overload protection. Designed to keep the solar system at an ideal working level by deploying the latest microcomputer-chip technology intelligence control with pulse width modulation (PWM) charging circuitry for higher efficiency.

SPECIFICATIONS

- Max solar input current 15A
- Max solar input voltage 22V
- PWM charging



CAMEC SOLAR PANEL CABLE KIT 2 PIECE

040437

This cable kit consists of a 3 metre +- lead and +- splitter enabling you to link two folding panels together for greater output.



SOLAR CABLES

- 050865 6MM X 3M**
- 050866 6MM X 5M**
- 050867 6MM X 10M**
- 050868 SOLAR CONNECTOR PAIR**

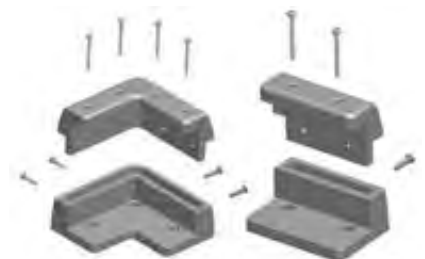

CAMEC SOLAR PANEL MOUNTING KIT 4 CORNER AND 2 SIDE BRACKETS

040436

For solar panels of all sizes with thicknesses up to 40mm. Secure to any surface - caravan, motorhome, boat, flat roof by adhesive or screw. Increases air flow and reduces panel temperature, reducing power loss. Each bracket comes in two sections - the base is first added to your roof at the correct location. The panel sits onto the these brackets, then the top bracket slides into the base bracket and is screwed in place. Locking screws can be placed from the top where your panel is less than 40mm thick.

CONNECTORS, SOCKETS & SWITCHES



CIRCUIT BREAKER 12V 20 AMP 036737

Circuit Breaker 12V,24V 20Amp. 12Volt circuit breaker. 20amp. These automatically reset after they cool down.

FEATURES

- Base is 50mm x 16mm with holes at 40mm centres.
- Total height from base to largest pole is 35mm.



CIRCUIT BREAKER 30AMP 12V 004347

Circuit Breaker 16V-24V 30Amp 12Volt circuit breaker. These automatically reset after they cool down.



CIRCUIT BREAKER 12V 15A 035751

SPECIFICATIONS

- 15amp



BRITAX CIGARETTE LIGHTER PLUG 035836

Universal cigarette lighter plug that will also plug into a "merit" style accessory socket when end ferrule is removed.



BATTERY CONTROL KIT 12V & 24V 100A 050862

Fool proof dual battery kit. DIY kit to allow charging of second battery from car alternator.



RELAY VOLTAGE DUAL SENSOR 140A 005054

Allows the unit to sense the voltage of both batteries between which it is connected.

SPECIFICATIONS

- Digital Voltage Sensing Relay (DVSR)
- Charges engine starting battery before combining auxiliary battery for charging
- Simple 3 wire connection
- Multi volt 12 & 24V
- Engages at 13.2 VDC
- Disengages at 12.7 VDC



VOLTAGE CONTROL RELAY 12 050861 - 160AMP

If your good times involve hardcore adventuring and long-haul off road journeys, you know you need a durable and reliable dual battery system. And your dual battery system needs a tough brick of a VCR so you can get from Bega to Bamaga, and everywhere in between, with complete peace of mind. Baintech's 160 amp VCR does the job!

It's powerful (160 amp continuous operation); it's tough (IP68 waterproof, fully self contained and dust proof); and it's versatile (can even start your 4WD from your auxiliary battery). From running your electric winch, to keeping your 12v fridge icy cold and maintaining your auxiliary battery to take over when you need it, the voltage control relay is designed to help power up the toughest, bumpiest, wettest, most power consuming adventures. To top it off, the voltage control relay is virtually foolproof to DIY install and conveniently sized to neatly fit into engine bays. It's the 4WDer's dream VCR.



POWER HARNESS FRONT BATTERY 050158

FEATURES

- Provides a 50A power supply through an Anderson style plug connection
- Suitable for powering large appliances such as 12V fridges
- The 50A supply can also provide enough power to charge auxiliary batteries



12V ACCESSORY PLUG

004172

Non-corrosive. Screws apart for fast, simple wire connection with screw terminals. No soldering required. Allows marine lights, etc. to be easily converted to convenient cigarette plug attachment.

SPECIFICATIONS

- 12-24V up to 16A



ACCESSORY PLASTIC PLUG & SCREW

004176

"Merit" style male plug.



FIXED POLARITY SQ SURFACE SOCKET

004186

T style surface mount socket 15A 2 pin polarized for use in 12V to 32V applications.

SPECIFICATIONS

- White



FIXED POLARITY PLUG CLEAR 32V/15A

004187

T style plug 15A 2 pin polarized for use in 12V to 32V applications.



FIXED POLARITY SOCKET CLEAR 32V/15A

004188

T style cord extension socket 15A 2 pin polarized for use in 12V to 32V applications.



2 PIN 20A INLINE PLUG AND SOCKET

004266

Generally the centre pin is used for active/ positive. The flexible rubber boot can be trimmed to allow larger wire.

FEATURES

- 2 pin unmounted



2 PIN 20AMP FLUSH MOUNT PLUG & SOCKET

004270

Easy to connect, no solder required.

FEATURES

- One side can be flush mounted. Comes as a set with plug and socket - to connect 2 polarised wires. These are the same as used on the older plugs for Chescold Fridges.



B76 4 PIN 35AMP PLUG

004274

Same as the 7 pin flat plug used on many caravans and trailers but with just 4 heavy duty pins.

SPECIFICATIONS

- 35amp
- B76 - 4 pin plug



B77 4 PIN 35AMP SOCKET

004275

These are the same size as the 7 flat sockets used at the rear of many cars - but accept just 4 heavy duty pins. (see 004274)



12-PIN FLAT PLASTIC VAN PLUG

004920 CLAM SHELL PACKED

004921 LOOSE

This plug allows for the trailer / caravan to connect to the car which has a 12 pin socket.

SPECIFICATIONS

- 2 rows of pins
- 7 pins rated at 20A
- 5 pin rated at 35A



12-PIN FLAT PLASTIC CAR SOCKET

004922 LOOSE

004923 CLAM SHELL PACKED

SPECIFICATIONS

- Car socket to accept 12 pin trailer plug (004920/004921)
- Supplied loose



BRITAX TRAILER PLUG

036739 7 PIN FLAT

This is the plug that goes on the trailer or caravan to connect indicator lights / electric brakes etc.

FEATURES

- ADR approved AS4177.5
- Tough ABS housings with nickel plated brass terminals

12 PIN FLAT TRAILER SOCKET AL ALLOY METAL

043638 FEMALE SOCKET (CAR)

043639 MALE SOCKET (TRAILER)

12 pin flat metal trailer plug & socket.

FEATURES

- Heavy duty durable alloy
- Circuits engraved into outer casing
- Stainless steel Phillips head screws
- Spring loaded dustproof cover protecting pins
- Saddle device to secure wiring



SPECIFICATIONS

- 5 pins rated at 35amps at 12V
- 7 pins rated at 15amps at 12V
- Suitable for 12V and 24V applications

7 PIN FLAT TRAILER SOCKET AL ALLOY METAL

043636 FEMALE SOCKET

043637 MALE SOCKET

Heavy duty 7 pin flat metal trailer plug & socket.

FEATURES

- Heavy duty durable alloy
- Circuits engraved into outer casing
- Stainless steel Phillips head screws
- Spring loaded dustproof cover protecting pins
- Saddle device to secure wiring



SPECIFICATIONS

- 7 pins rated at 15amps at 12V
- Suitable for 12V and 24V applications



7-PIN LARGE ROUND PLASTIC VAN PLUG

004897

SPECIFICATIONS

- Trailer side large round 7 pin plug
- Each pin rated at 30A 12V



7-PIN LARGE ROUND METAL VAN PLUG

004900

SPECIFICATIONS

- Trailer side large round 7 pin plug
- Each pin rated at 30A 12V



7-PIN SMALL ROUND METAL CAR SOCKET

004911

SPECIFICATIONS

- Car side small 7 pin socket
- Each pin rated at 15A 12V
- Accepts both plastic and metal small 7 pin trailer plugs



7-PIN SMALL ROUND METAL VAN PLUG

004909

SPECIFICATIONS

- Trailer side small round 7 pin plug
- Each pin rated at 15A 12V



7-PIN LARGE ROUND METAL CAR SOCKET

004901

SPECIFICATIONS

- Carside large 7 pin socket
- Each pin rated at 30A 12V
- Suits 004897/004900



7-PIN LARGE ROUND PLASTIC CAR SOCKET

004914

SPECIFICATIONS

- ABS plastic
- Car side
- Accepts large 7 pin round trailer plug 004897/004900



7 PIN FLAT AND ANDERSON PLUG CONNECTOR

051091

- All-in-one trailer socket with 7 Pin Flat & 50A Anderson style connector with Nite-lite and Reed switch
- Designed for camper trailers and caravans requiring high current power to the trailer
- The reed switch deactivates the reverse sensor while the trailer is connected



12 PIN SOCKET AND ANDERSON PLUG CONNECTOR

051092

- All-in-one trailer socket with 12 Pin Flat & 50A Anderson style connector with Nite-lite and Reed switch
- Designed for camper trailers and caravans requiring high current power to the trailer
- The reed switch deactivates the reverse sensor while the trailer is connected



7-PIN FLAT CAR SOCKET

004917 SOLD LOOSE

004918 RETAIL PACKED

The 7 pin flat socket is mounted to car and will accept the 7 pin flat trailer plug. These style connectors are made by a number of manufactures and each type can be used together, they are not brand specific.

FEATURES

- Manufactured to comply with Australian standards
- Durable design with proven history
- Premium materials



ARK 7 PIN TRAILER PLUG FLAT

035824

7 quick assembly flat trailer plug (includes magnet). These connectors are made by a number of manufactures, but will fit into each brand provided the style is the same.

FEATURES

- Magnetises to trailer when not in use
- Avoids damage to plug
- Brass terminals
- Superior quality

SPECIFICATIONS

- FP87



ARK 7 PIN CAR TO 7PIN VAN FLAT

035828

Ark 7 Pin round Car To 7 Pin Flat trailer. This a 7 pin plug from a caravan or trailer and allows it to connect to a car with a 7 pin round (small) socket.



ARK 7 PIN FLAT TO 7 PIN ROUND VAN

035830

Allows trailer plug conversion from 7 pin flat cart to 7 pin large round trailer.



CABLE 7-CORE SHEATH 7/7.32 X MTR

004137

- Common wiring used for trailers and vans
- Suitable for all 7 pin connectors



7-PIN SMALL ROUND LED TRAILER PLUG

004928

In-built Circuit Tester to individually test power through each circuit of your wiring.



7-PIN FLAT LED TRAILER

004930 PLUG

These plugs and sockets feature a built-in circuit tester delivering an easy way to ensure each pin is wired and functioning correctly. To operate, simply press the switch on the housing of the plug or socket while connected to the vehicle and apply park, brake and indicators. Each LED should illuminate to indicate a successful power connection.

A switch has been built into the KT LED Trailer Plug and Socket to allow the user the option to turn the LED lighting on or off to prevent distractions to other motorists. It is recommended that the LEDs be turned off after checking electrical circuits.

FEATURES

- Inbuilt LED circuit tester
- 7 pin flat trailer socket – LED
- 15A at 12V
- Threaded screw cap



ROUND 7 PIN LARGE CAR - 7 PIN SMALL VAN CONNECTOR

004938

FEATURES

- 7 pin large round car to 7 pin small round van



7 PIN LARGE CAR X 7 PIN FLAT VAN

004951

FEATURES

- 7 pin large round car to 7 pin flat van



7 PIN FLAT CAR X 7 PIN LARGE VAN

004953

FEATURES

- 7 pin flat car to 7 pin large round van



7 PIN FLAT CAR X 7 PIN SMALL VAN

004955

FEATURES

- Car 7 Pin flat connector to 7 Pin small van



SWITCH ROCKER 12V 30A WITH LED LIGHT

005007

SPECIFICATIONS

- 30amp
- Red LED light



SWITCH ROCKER 12V 16AMP

005008 BLACK

005012 RED ILLUMINATED



TOGGLE SWITCH METAL 12V 20A

005034

SPECIFICATIONS

- Single pole, single throw
- Silver contacts
- Screw terminals
- 12.5mm mount opening required



EXTENSION SOCKETS

005105 CLEAR SOCKET 15A

005107 10A ORANGE TOP PLUG

005108 15A CLEAR TOP PLUG

Cord extension plugs and sockets for ordinary duty 3 core flexible cords.



CAMEC 15A EXTENSION LEAD

042887 17M

042888 22M

SPECIFICATIONS

- Extra value
- 2 metres longer than other brands
- Safety LED illuminated socket
- 15A large blade earth pin



ELECTRICAL LEAD STORAGE BAG

040559

Holds up to 20m electrical lead.



CAMPRITE ELECTRICAL LEAD STORAGE BAG

051526



MULTI-REEL LARGE & COMPACT

043265 LARGE REEL

005313 COMPACT REEL

SPECIFICATIONS - LARGE

- Ready for your power lead or other uses.
- 37 cm diameter
- 44 cm including handle
- 8 cm deep
- 0.9 kg when empty
- Approx. 30m power cord capacity

SPECIFICATIONS - COMPACT

- 34cm diameter including handle
- 6.5cm deep
- 0.6kg when empty. Holds approx 15m power cord



EXTENSION LEAD JOINING COVER WEATHER PROOF

005112

Weatherproof threaded coupling, impact resistant.

SPECIFICATIONS

- Diameter: 66mm



SWITCH PLATE 1 GANG 31 WHITE

005199

Universal dimmer switch plate with 1 gang.

SPECIFICATIONS

- Suits 005225 switch mechanism
- 72mm x 32mm
- 55mm screw fixing centres



SWITCH SINGLE DEEP WHITE DOUBLE POLE 240V (30DD)

005233

Single mechanism, deep plate, double pole switch.

FEATURES

- Deep plate

SPECIFICATIONS

- Double pole
- Dimensions: 78mm(h) x 36mm(w)
- 240V
- 10amp
- White



POWER POINT SINGLE WHITE SHALLOW CLIPSAL 15D

005200

Single switched sockets with shallow plate.

SPECIFICATIONS

- Dimensions: 115mm x 73mm
- 240V
- Double pole
- White



POWER POINT SINGLE WHITE DEEP CLIPSAL 15DD

005202

Single switched socket with deep large plate.

FEATURES

- Deep plate

SPECIFICATIONS

- Dimensions: 115mm x 73mm x 33mm
- 240V
- Double Pole
- White



POWER POINT DOUBLE SHALLOW WHITE CLIPSAL 25D

005209

Double switched sockets with shallow plate.

FEATURES

- Shallow plate

SPECIFICATIONS

- Dimensions: 115mm x 73mm
- 240V
- Double pole
- White



POWER POINT DEEP MOUNTING BLOCK WHITE CLIPSAL 449A

005212

Suits all Clipsal standard pattern power points.



SWITCH SINGLE DEEP HPM DOUBLE POLE 240V (1A770PWE)

005237

Single mechanism, deep plate, double pole, switch.

SPECIFICATIONS

- 240V
- Double pole
- White
- 81 x 34 x 21 mm



POWER POINT SINGLE HPM DEEP 1/788P

005214

Double pole switched socket with plate.

SPECIFICATIONS

- HPM, deep plate
- Single
- White
- 81mm x 81mm x 32mm



POWER POINT DOUBLE HPM WHITE

005216

2 x double pole switched sockets with deep plate

- 132mm x 81mm x 32mm

SPECIFICATIONS

- 2 x double pole switched sockets with deep plate
- 132mm x 81mm x 32mm



SWITCH MECHANISM WHITE DOUBLE POLE 30MD

005225

Replacement single mechanism.

SPECIFICATIONS

- 10A
- Double pole
- White

WHITE DOUBLE POLE SWITCH 10AMP 035757

Single mechanism, double pole switch.

FEATURES

- Shallow plate

SPECIFICATIONS

- Dimension: 78mm(h) x 36mm(w)
- 10A
- 240V
- White



240V DOUBLE POLE POWER POINT

051118 RETAIL PACK

AC input 250V 10amp.



12V TO 5V OVAL USB PORTS

051119 TWIN USB PORTS

Ideal for charging phones, tablets. Designed for use in RVs.

SPECIFICATIONS

- 12 volt input
- 2x 5V output (2.1A)



CAMEC 12V 50A ANDERSON STYLE PLUG

044653 GREY

SPECIFICATIONS

- Great for RV's, 4WD, boating, camping and more!
- 6AWG cable size (up to 13.3 sq mm)
- Contacts can be crimped or soldered
- Impact resistant polycarbonate housing

SWITCH BATTERY ISOLATOR 4 POS

051057

SPECIFICATIONS

- 69mm x 69mm x 74mm

FEATURES

- Compact battery isolator switch 4 position for dual batteries
- Surface mounted with slide-out cable entry panels
- Switching positions (off / 1 / 1&2 / 2)
- 1000A @ 12V for 30 seconds
- 500A @ 24V for 30 seconds
- 250A @ 50V for 30 seconds
- 300A @ 12V continuous load maximum
- 150A @ 24V continuous load maximum
- 75A @ 50V continuous load maximum
- Mounting screws supplied
- 1 year warranty



BATTERY SWITCH MINI ON/OFF

051059

SPECIFICATIONS

- 45mm diameter
- Removable knob for safety and security

FEATURES

- Robust weather resistant battery switch, features brass terminals and heavy-duty plastic construction making it ideal for marine and automotive applications
- East turn knob
- 1000A @ 12V for 5 seconds
- 500A @ 24V for 5 seconds
- 100A @ 12V continuous load maximum
- 50A @ 24V continuous load maximum
- Mounting screws supplied
- 2 position features - On / Off
- 1 year warranty



ANDERSON PLUG 50A

050855 BLUE

050856 RED

Never mix leads again with these colour coded Anderson plug ends.



ANDERSON PLUG BOOT COVER

050858

Keeps dust and dirt out of the Anderson plug

GLOBES & FUSES



BEP 6 WAY FUSE HOLDER (SCREW TERMINALS WITH COVER)

034511

BEP 6 way fuse holder with screw terminal cover.

FEATURES

- Clip on cover with label positions for each fuse
- Position for spare fuses
- Clear polycarbonate cover

SPECIFICATIONS

- Maximum per circuit: 30A
- Maximum per block: 100A



FUSE BLADE TYPE AF 10A

004312

Fuse blade 19mm wide with 2mm of insulation.

SPECIFICATIONS

- Pack of 5
- 10A



FUSE BLADE TYPE 15 AMP (5)

004315

SPECIFICATIONS

- Pack of 5
- 15A



FESTOON GLOBES

12V 2 PACK

- 004797 - 3W 8MM X 28MM
- 004804 - 5W 11MM X 36MM
- 004810 - 10W 10MM X 31MM
- 004822 - 21W 15MM X 41MM

12V 10 PACK

- 004795 - 3W 8MM X 28MM
- 004802 - 5W 11MM X 36MM
- 004805 - 5W 11MM X 41MM
- 004808 - 10W 10MM X 36MM
- 004815 - 18W 15MM X 41MM
- 004820 - 21W 25MM X 41MM



FUSE BOX & COVER 4WAY BLADE

004331

Blade fuse box with transparent cover, gasket and terminals.

FEATURES

- 4 blade



FUSE BOX & COVER 6WAY BLADE

004333

Current draw: 30amp

Size: 100L x 37H x 45W



FUSE HOLDER INLINE BLADE & WIRE

004330

Current draw: 30amp



LED MR16 12V GLOBE

038821

- 30 LEDs



12V LED GLOBE MR16

040713

LED MR16 replacement globe for any MR16 holder

FEATURES

- More durable than halogen bulbs
- Vibration proof design
- Easy installation, just plug into a standard MR16 holder

SPECIFICATIONS

- Dimension: 50mm(l) x 49.8mm(h) x 50mm(w)
- Operating Voltage: 12V



FUSE BOX 8 WAY 25A 12V BLADE FUSE

004338

Blade fuse box.

FEATURES

- Single power in
- 8 blade
- 80 x 86 x 21
- 25A rating per circuit at 12V
- 150A max per block



**GLOBE SINGLE CONTACT 4W
12V/10**

004798

SPECIFICATIONS

- Commonly used on license plate lamps
- Pack of 10



GLOBE S/CONTACT 12V 4W/2

004801

Globes, Single Contact, 12V 4W, Pack of 2.



**GLOBE WEDGE 12V 21CP 15
X 35MM**

004834 2 PACK

004833 10 PACK

Cool White

SPECIFICATIONS

- 21CP 15mm wide



**GLOBE SINGLE CONTACT 21W
12V/10**

004847 12V 21W

SPECIFICATIONS

- 10 per box



**GLOBE SINGLE CONTACT 21W
12V**

004849

12V 21W

SPECIFICATIONS

- 2 pack



**GLOBE DOUBLE CONTACT 21/5W
12V/10**

004854

SPECIFICATIONS

- 10 per box
- 12V 21-5W Offset Pins



**GLOBE D/CONTACT 21/5W
12V/2**

004856

SPECIFICATIONS

- 2 pack



GLOBE HALOGEN G4 12V 5W

004870



GLOBE HALOGEN G4 12V 8W

004872



**12 LEDs SMD G4 COOL WHITE
SIDE PIN**

040714

LED, cool white, 12 LEDs, SMD G4 side pin.

Replaces G4 halogen globe for brighter/more economical lighting.



**12LEDs SMD G4 IN COOL WHITE
BACK PIN**

040715

LED cool white, 12 LEDs, SMD G4 back pin.

Replaces G4 halogen globe for brighter/more efficient lighting.



**LED 42 ROUND REPLACEMENT
GLOBE**

040596

This LED light is designed to replace a traditional 2D fluorescent lamp.

FEATURES

- Anti vibration design
- Instant start, no flickering
- Innovative LED technology for cool lighting source - avoid lens distortion caused by high temperature

SPECIFICATIONS

- Dimensions: 140mm diameter
- 42 super bright 5050 LED chips
- Operating Voltage: 12V DC



**CAMEC LED G4 TOWER 9 LED
12V COOL WHITE**

040172

These LEDs are a perfect replacement G4 style globes.

FEATURES

- In-built with 9 super bright SMD chips
- Easy installation with a standard G4 connector

SPECIFICATIONS

- Dimensions: 9.9mm(l) x 32.3mm(h) x 10.7mm(w)
- Light Output: 180LM
- Supply Voltage: 12V DC



6 LED G4 BACK 12V COOL WHITE 040178

This back pin LED is ideally suited to halogen down light globe replacement. LED 6 piece 12V G4 back cool white.

FEATURES

- 6 Cool white super bright LEDs
- Low heat, high efficiency
- Up to 50,000 hours life - never replace a down light globe again!

SPECIFICATIONS

- Dimensions: 35mm Diameter
- Light Output: 120LM
- Operating Voltage: 12V



G4 SIDE 6 LED 12V COOL WHITE 040173

LED G4 bulb, 6 LEDs, 12V, 1.8W.

FEATURES

- Easy installation with a standard G4 connector
- More durable compared to halogen bulbs

SPECIFICATIONS

- Dimensions: 35mm(l) x 5mm(h) x 35mm(w)
- 120 degrees flat angle illumination
- Supply Voltage: 12V
- Wattage: 1.8 and 180LM



FESTOON 9 LED 42MM 12V COOL WHITE

040174

LED Globe Replacement festoon 9 LED, 12V, cool white, suitable for fog lights, daytime running lights and dome light lamp pathway lights.

FEATURES

- Easy to install
- Long service life
- Low power of consumption

SPECIFICATIONS

- Dimensions: 16.55mm(l) x 8.4mm(h) x 42mm(w)
- Supply Voltage: 12V



FESTOON 9 LED 39MM 12V COOL WHITE

040175

LED Globe Replacement festoon 9 LED cool white 12V, suitable for fog lights, daytime running lights and dome light lamp pathway lights.

FEATURES

- Long service life
- Easy to install
- Low power consumption

SPECIFICATIONS

- Dimensions: 16.55mm(l) x 8.4mm(h) x 39mm(w)



BAYONET 27 LED SINGLE CONTACT 12V COOL WHITE 040176

LED bulb that will replace 12V lighting units that use the BA15S single contact parallel pin.

FEATURES

- Low heat rating, which reduces lens distortion and provides direction illumination

SPECIFICATIONS

- Dimensions: 20mm(l) x 49mm(h) x 20mm(w)
- Operating Voltage: 12V DC
- 2.7W
- Parallel pin
- Connector: Single with 360 degree lighting angle



BAYONET 27 LED DOUBLE CONTACT 12V COOL WHITE 040177

LED bulb that will replace 12V lighting units that use the BA15D double contact parallel pin, 360 degrees.

FEATURES

- Low heat rating, which reduces lens distortion
- Vibration proof design

SPECIFICATIONS

- Dimensions: 20mm(l) x 49mm(h) x 20mm(w)
- Operating Voltage: 12V DC
- 2.7W
- Parallel pin



T10 13 LED 12V COOL WHITE 040171

LED replacement globes, T10 13 LEDs 12V cool white.

FEATURES

- 150 lumens
- 360 degree lighting angle

SPECIFICATIONS

- Dimensions: 10mm(l) x 43.2mm(h) x 10mm(w)
- 1.8W
- Used to replace wedge style filament globes



T10 REPLACEMENT 18 LED 040815

SPECIFICATIONS

- LED replacement globe T10 cool white
- Ideal replacement for older "wedge" type filament globe
- 55mm(l) x 27mm(w) x 6mm(d)
- 210LM

INTERIOR & EXTERIOR LIGHTING



CEILING LIGHT

039829

LED square light with 60 white LEDs and 6 blue LEDs that can be used as a night light.



NARVA 87640 LED DOWN LIGHT

039943

SPECIFICATIONS

- 10-30V courtesy lamp
- Switches on/off by pushing the face
- Flush mount or surface mount using provided spacer



CAMEC LED SQUARE CRYSTAL TOUCH LIGHT 4 SECTION

040310

Camec LED square crystal light, 4 section complete with touch button.

FEATURES

- Four phase button switch to adjust the light between blue, daylight med and maximum
- Highly polished metalized reflector for consistent and optimum interior illumination
- Frosted internally for glare reduction
- Caps provided to cover screws, leaving a clean finish after installation

SPECIFICATIONS

- Dimension: 180mm(l) x 13mm(h) x 180mm(w)
- Operating Voltage: 12V DC
- 120 degree flat angle illumination



CAMEC LED SQUARE CRYSTAL TOUCH LIGHT 2 SECTION

040311

Camec LED square crystal light, 2 section complete with touch button.

FEATURES

- Four phase button switch to adjust the light between blue, daylight med and maximum light distribution
- Highly polished metalized reflector for consistent and optimum interior illumination
- Frosted internally for glare reduction
- Caps provided to cover screws, leaving a clean finish after installation

SPECIFICATIONS

- Dimensions: 220mm(l) x 13mm(h) x 90mm(w)
- Operating Voltage: 12V DC
- 120 degrees flat angle light illumination



CAMEC LED SQUARE CRYSTAL TOUCH LIGHT

040312

FEATURES

- With on/off button
- Highly polished metalized reflector for consistent and optimum interior illumination
- Frosted internally for glare reduction
- Caps provided to cover screws, leaving a clean finish after installation

SPECIFICATIONS

- Dimensions: 90mm(l) x 13mm(h) x 90mm(w)
- Operating Voltage: 12V DC
- 120 degrees flat angle light illumination



FRILIGHT CIRRO INTERIOR HALOGEN LIGHT 12V

004445

FEATURES

- Surface mounted
- 10W halogen globe
- Switch

SPECIFICATIONS

- 12V
- White with opaque lens
- Dimensions: 250mm(l) x 48mm(h) x 250mm(w)



CAMEC 12V 24 LED 70MM RECESSED DOWN LIGHT

040712

Super bright, stylish LED down light suitable for all types of interior applications.

FEATURES

- 24 cool white LEDs
- Low heat, high efficiency
- Up to 50,000 hours life - never replace a down light globe again!

SPECIFICATIONS

- Mounting Hole Diameter 53.5mm
- Mounting Depth: 11mm
- Dimensions: 70mm(l) x 16mm(h) x 70mm(w)
- Light Output: 240LM
- Operating Voltage: 12V



LED INTERIOR LIGHT BUILT IN ON/OFF SWITCH

051049 25.5W 675LM ROUND 3 BRIGHTNESS SETTINGS 130MM(W) X 18.5MM(H)

051053 4.4W 186LM 130MM X 54MM X 12MM

051054 11.6W 518LM 300MM X 54MM X 12MM

051055 26.8W 794LM 600MM X 54MM X 12MM

The new Whitevision Series interior light features high grade SMD L.E.D technology to provide powerful interior illumination in a compact low profile design, combined with in-built On/Off touch switch and smart surface mount design makes this light ideal for a wide variety of vehicle interior applications.

SPECIFICATIONS

- Applications: Trucks, Heavy Trailers, Trailers, Caravans
- Functions: Interior Illumination
- Voltage: 10-30V
- Mounting: Smart Surface Mount
- Material: Polycarbonate lens, ADC12 Aluminium Housing
- Environmental: IP67



CAMEC LED GRAB HANDLE WITH BLUE NIGHT LIGHT FUNCTION

041478 CHROME

041479 BLACK

041480 WHITE

Features stylish ergonomic handle design for easy grip that is salt water and UV protected. Includes 42 LED cool white illumination lights, soft blue LED night light, glow in the dark switch and optional output to activate a step light. Available in 3 finishes. Direct replacement for Bargman style handle lights.

FEATURES

- Press switch to activate the blue light options. Blue night light, main white LED, optional step light or to turn on/off
- Press and hold the switch when the blue night light is on to turn it off without turning on the main white light
- Stylish ergonomic handle design for easy grip
- Salt water and UV protected
- Convenient 42 LED cool white illumination light
- Soft blue night light
- Glow in the dark switch cover for easy location of the handle at night
- Switch 12V output for an optional step light (not supplied)
- NOTE: The switched output is negative

SPECIFICATIONS

- Dimensions: 144mm(l) x 46mm(h) x 222mm(w)
- Wiring Colours: Red (+) 12V, Black (-) 12V
- White Switched (-) 12V for Step Light output
- Wattage: 3.5W
- 12V DC Operation
- Extrudes approximately 28mm from external van wall



EXTERIOR PORCH LIGHT WITH SWITCH 12V

004514

FEATURES

- Rugged design

SPECIFICATIONS

- Dimensions: 148mm(l) x 87mm(h) x 64mm(d)



EXTERIOR LIGHT ANNEX CLEAR LENS NO SWITCH 12V

004515

Waterproof recessed light 12V with clear lens.

SPECIFICATIONS

- Dimensions: 150mm(l) x 88mm(h) x 55mm(d)
- No switch



NARVA INTERIOR ROOF LIGHT AND SWITCH 12V

004388



LIGHT ANNEX CLEAR LENS ONLY

004517

Clear lens only.
130 x 50mm
Replacement for 004515/004516.



12V TURN STRIP LIGHT

034342

FEATURES

- Switch

SPECIFICATIONS

- 12V
- 30 LEDs
- 20Amp
- 180° turntable



CEILING LIGHT 60 LED WHITE RECTANGLE 12V

039838

FEATURES

- 372mm(w) x 136mm(h) x 30mm(d)



FRILIGHT COMET EYEBALL WITH SWITCH FACE FIX 10W - WHITE 12V

004494

Surface mounted halogen eyeball light with switch. Clear lens and 10W globe.

SPECIFICATIONS

- Dimensions: 33mm(h)
- 100mm diameter



EXTERIOR LIGHT ANNEX WITH SWITCH 12V

004516

12V Annexe Light Clear Lens, with switch.

SPECIFICATIONS

- Dimensions Length 150mm x 88mm x 55mm
- Hole centres 100mm x 45mm



CAMEC BARGMAN REPLACEMENT LENS

041806

Suitable for Bargman grab handles.

FEATURES

- UV protected
- Suitable for 3061-115/120 Bargman Grab Handles
- 107mm(l) x 52mm(w)



CAMEC GRAB HANDLE REPLACEMENT LENS UV

041807

Camec Grab handle replacement lens.

FEATURES

- UV protected
- Used to replace the lens on the previous Camec grab handle (non-LED version)
- 107mm(l) x 57mm(w)
- Embossed with the word "Camec" at the top



CAMEC GRAB HANDLE REPLACEMENT LENS

042706

Replacement Lens for 041478, 041479 and 041480.



LIGHT SINGLE CEILING OPAL 12V

004526

Milky lens.



JACK CONNECTION - WHITE

004530

12V Removable bed light Jack socket. These suit the 12V lights.

FEATURES

- They are sold separate for those wishing to have more than one possible location for the light. They are hardwired to the 12v power supply and the lights can be connected when required.

SPECIFICATIONS

- They measure 60mm dia at the base and extend 35mm.
- Suit Jack Diameter of 6mm x 30mm.



LIGHT DUEL INTERNAL DOME AND SWITCH 2 X 18W 12V

004549

Dual interior dome light with off/on rocker switch. Bright, wide-angle light output 2 x 21CP (16W) globes.

FEATURES

- Pre-wired and surface mounted
- 12V globes included



LIGHT TUBE 8W FLUORESCENT

004555

300mm long, 16mm diameter.



LIGHT FLURO TUBE 13W

004560

SPECIFICATIONS

- 516.9mm (l) excluding pins x 16mm diameter
- 13 Watt



LIGHT FLURO TUBE 15W

004561

SPECIFICATIONS

- 12V 15W
- 430mm (not including pins) x 22mm wide
- Cool White
- 850 Lumens



KNOB LIGHT GLASS PLASTIC

005171

Replacement knob for 12/240V Oyster Light.



BAYONET HOLDER 12VOLT

005179

Accepts BA15D bulbs or LEDs.
Double contact.



WHITE PLAST SHROUD SUIT TC LAMP

005182

These fit the older oyster lights.

**SLIM DOWN LIGHT SILVER 12V****051013****FEATURES**

- Ideal use in all interior and exterior marine, caravan, motorhome and camper trailer applications Most commonly used for cockpit lighting and down lighting in small areas
- Surface mount
- 12 x Super bright LEDs with a light output comparable to a 15-20 watt halogen
- Tinned wires
- Waterproof rating of IP66
- No switch
- 1 year warranty

SPECIFICATIONS

- Amps: 0.4A
- LED Colour: Cool White
- Frame Colour: Silver
- Diameter: 83mm
- Depth: 12mm
- Switch: Required
- Volts: 12V
- Lumens: 480
- Watts: 4.8W

**LED INTERIOR LIGHT 12/24V****051014****FEATURES**

- Ultra slim
- Ideal for use in all interior marine, caravan, motorhome and camper trailer applications
- Polycarbonate lens
- 60 Powerful SMD LEDs
- Decorative bezel to hide the mounting fixtures
- Surface mount
- Waterproof rating of IP66
- Touch on/dim/off switch
- Memory function recalls last setting when centrally switched
- 1 year warranty

SPECIFICATIONS

- Length: 220mm
- Width: 100mm
- Amps: 0.26
- LED Colour: White
- Frame Colour: White
- LED Qty: 60
- Depth: 13mm
- Volts: 12V/24V
- Lumens: 216
- Watts: 3.12

LED ROUND INT. 130MM (TOUCH)**051015 WHITE****051016 WHITE/RED****FEATURES**

- Ideal for RV's and Caravans
- Dimmable
- ABS housing
- Sealed ESD protected LEDs
- 3 touch settings
- 051015: Touch on
Touch dim
Touch off
- 051016: Touch on
Touch red
Touch off
- Surface mount
- Waterproof rating of IP66
- LED lifespan of 50,000 hours
- 130mm tinned wires
- Includes 1x silver and 1x white trim for choice of finish
- 1 year warranty

**SPECIFICATIONS**

- Diameter: 130mm
- Depth: 11mm
- LED Qty: 42
- Volts: 12V/24V
- Watts: 3
- Amps: 0.25 Amps / 0.15 Amps

LED MULTI PURPOSE STEP LIGHT**051017 BLUE****051018 COOL WHITE****FEATURES**

- Bright and durable surface mount suitable for a variety of indoor and outdoor applications
- 3 x Taiwanese 3535 LED chips comparable to a 10 watt halogen
- LEDs are sealed in polycarbonate
- 304G stainless steel frame
- Waterproof rating of IP68
- Rated at 50000 hours
- Suitable for underwater use

SPECIFICATIONS

- 5 year warranty
- Length: 79mm
- Width: 22.5mm
- Amps: 0.15
- LED Colour: Blue 051017, LED Colour white: 051018
- Volts: 12V
- Lumens: 100
- Watts: 1.8

**LED FLEX SPOTLIGHT 12 LEDs****035641**

Ideal bedside light.

FEATURES

- Flexible

SPECIFICATIONS

- 12V
- 12 LEDs
- 0.7W

**LED HANDLE LIGHT****034100****FEATURES**

- Chrome plated ends
- Waterproof suitable for outside use
- Clear acrylic handle with bubble effect
- Lights up blue when turned on
- Needs to be wired in
- No switch

LED READING LAMP 12V WITH SWITCH**051020 500MM****051021 460MM****FEATURES**

- Ideal for use in all smaller interior marine, caravan, motorhome and camper trailer applications. Most commonly used for bed head lighting in camper trailers
- 12 x super bright 5630 SMD LEDs
- Waterproof rating of IP66
- Flexi neck enabling it to be put in almost any position required
- Horizontal and vertical mounting
- Mini rocker switch
- 1 year warranty

SPECIFICATIONS

- Amps: 0.16
- LED Colour: Cool White
- LED Qty: 12
- Volts: 12V
- Lumens: 192
- Watts: 1.92





FRILIGHT MINI SPOT WHITE

044470

Adjustable LED light for wall or under shelf mounting.

SPECIFICATIONS

- Lumens: 124
- Height: 90mm
- Width: 60mm
- Depth: 85-120mm
- Base Dimensions: 75mm x 40mm
- With switch



LED FLEX READING LAMP 12V

035640

Ideal bedside light.

FEATURES

- 12V
- Flexible
- Switch

SPECIFICATIONS

- 9 LEDs
- Overall height from base to tip of lens is 140mm
- Base 45mm



10" ROUND 24 LED LIGHT 12/24V

044080

SPECIFICATIONS

- Warm white
- Opaque plastic lens
- Internal use only
- With switch



LIGHT METEOR GOLD MR16 10W

038160

SPECIFICATIONS

- Gold finish
- With switch
- Supplied with MR16 halogen bulb

POWER 12V



VOLTMETER 8-16V

005049 BULK

Features expanded scale face. Colour coded for easy reading. Recessed mounting.

SPECIFICATIONS

- Dimensions: 108mm(l) x 108mm(h) x 56mm(d)



CIRCUIT BREAKER PANEL BEP 12V 4 SWITCH 20A

004350

SPECIFICATIONS

- 47mm(d)
- 20amp



150A WATT METER

0050864

Simple to connect: simply plug your regulated solar source to the 'source' side of the watt meter, and your battery/load to the 'Load' Anderson connector. Once connected and power is flowing through, the watt meter will give you real time readings of:

- Current (Amps/A)
- Voltage (Volts/V)
- Power (Watts/W)

SPECIFICATIONS

- Operating Voltage : 4.8 – 60V DC
- Measures 0-150amp
- The Watt Meter is designed for systems using less than 60 V and carrying currents up to 130amp
- Weight : 82g
- Display : 16X2 backlit LCD display



SINGLE CONTOUR SWITCH BLACK VERTICAL 12V

005024

Vertical on/off. Labels included.

SPECIFICATIONS

- Single switch
- Black
- 10A max



SWITCH 12V - 10IN OYSTER LIGHT

005178

These small switches are used for 12V lights only.

SPECIFICATIONS

- Dimensions: (L)25mm x (W)15mm x (H)30mm



CONTROL PANEL 6 WAY - BULK TRAVELLER

005043

Supplied with ATC fuses accessible from front Cover. Square dimensions allow for modular mounting. Includes label sheet, LED on each switch, matching trim conceals and mounting screws.

SPECIFICATIONS

- Dimensions: 108mm(l) x 108mm(h) x 36mm(d)
- 6 switch, fused panel



DUAL USB SOCKET BLACK 4.8

050850

Dual Universal USB socket
Rated input DC: 12V/24V
Output: 5V/4.8A total
Suitable for charging tablets and smart phones.

FEATURES

- Durable – socket you can trust not to break
- Robust – strong end plate design and UV stabilised PVC housing
- Safe – sockets that prevent shorting and fires
- Improved – new terminal designed to avoid short circuits
- With tinned copper inserts
- Allowing you to charge your modern devices easily on the go
- 2 x 2.4A



DUAL USB SOCKET WHITE 4.2A

050851

SPECIFICATIONS

- 2 x Universal USB socket 2.1A ea
- Rated input: 10 – 20V DC
- Suitable for charging tablets and smart phones
- The Baintech white USB is perfect for caravans and camper trailers
- Output DC 5V/4.2A total



FLUSH MOUNT CIGARETTE SOCKET

050847 BLACK

050848 WHITE

Single standard cigarette lighter socket, with surface mount plate, suitable for a range of appliances.

FEATURES

- Ciga socket
- Black flush mount or white
- C/W PVC surface mounting plate
- Designed for heavy duty use



SURF MOUNT CIGARETTE SOCKET WHITE

050852

SPECIFICATIONS

- White Ciga Socket
- White Surface Mount
- C/W PVC housing
- Designed for heavy duty use
- Rated: 0-36V DC/15amp max load



SURF MOUNT DOUBLE SOCKET

050853 MERIT + CIGARETTE SOCKET

050854 CIGA + UNIVERSAL USB SOCKET

The all-in-one convenient housing keeps your plugs tidy and uses quality UV stabilised PVC so that it lasts for years to come. And like all products from the Power Systems Experts, the Double Socket is safe, designed to prevent shorting and fires for your peace of mind.



12V DC VOLTMETER

050859

LED DC voltmeter is capable of monitoring the voltage of your vehicle's battery or electrical system. The voltage of a battery will let you know the usable power you have left and therefore it will give you an indication of run time remaining for your appliances.

- 12v DC Voltmeter
- DC 12v output
- LED indication
- Recess mount



12V CIG SOCKET SURFACE MNT

004171

Mounted inside a UV stabilised black box for surface mounting.



12V CIG SOCKET RECESS MOUNTING

004170

Suits 12-24V up to 16A.

POWER 240V



EXTERNAL POWER "OLD STYLE" OUTLET 15 AMP

035756

Includes foam seal.



RCD/MCB 240V 16A BREAKER ONLY

005099

SPECIFICATIONS

- Safety switch circuit breaker
- Combination RCD MCB
- 2 module double pole
- 4.5KA
- 16amp
- 30mA tripping current



POWER INLET NEW STYLE BLACK

044789

Designed to be fitted to caravans, motorhomes and campers, this 15amp inlet is used to bring 240V power into the RV.

FEATURES

- Spring-loaded weatherproof flap
- Raised inlet allows use with power leads with weatherproof flange
- Includes rear foam seal

SPECIFICATIONS

- Dimensions (mm): 80(w) x 110(h)
- IP34 Rating (with plug inserted)
- Colour: Black
- Depending on wall thickness you may also need a backing plate



POWER INLET WHITE "O/S" FLAP ONLY

005188

Clipsal power inlet, 15amp, Replacement lid, pre 2006.

FEATURES

- Includes flap, plus spring and foam seal.



POWER OUTLET NEW STYLE 10A

005198 WHITE

Compatible with new extension cords with a shroud as required by Australian Standards.

FEATURES

- Inlet connection complete with waterproof flap and sealing gasket

SPECIFICATIONS

- 10A
- Dimensions (cover): 80mm(w) x 100mm(h)
- Recess (into the wall): 35mm at the centre
- Used to take power out of RV
- IP34 rated



EXTERNAL POWER OUTLET - 10AMP

051556 BLACK

Power Outlet, Clipsal, 10amp, Weatherproof lid, BLACK. Used to TAKE 240V power FROM an RV.

FEATURES

- These outlets allow the flap to stay closed when the extension cord is inserted. Comes with a rear foam seal, backing plate and screw caps. This is a different size from older style and should only be used in new applications.



OLD STYLE SPACER BLOCK WHITE

005190

Power Inlet / Outlet backing plate, Pre-2006, CLIPSAL. These are required when the RV wall thickness will not fully accommodate the rear section of the power inlet or outlet. They simply give extra space.

FEATURES

- This style is suitable only for the OLD STYLE inlets and outlets, by CLIPSAL (Pre 2006)

SPECIFICATIONS

- 13mm thick



SPACER BLOCK TO SUIT NEW STYLE INLET/OUTLET

005194

SPECIFICATIONS

- White
- Suits 005193 and 005198.



POWER INLET NEW STYLE WHITE

005193

Power Inlet, Clipsal, 15amp, Weatherproof lid, WHITE. Used to bring 240V power into the RV.

SPECIFICATIONS

- They cover 80mm wide x 100mm
- Recess into the wall 35mm at the centre
- Spacer block can be used on outside to reduce depth inside part 005194

AMPHIBIAN 15A SURGE PROTECTOR

050120

Ampfibian's S1000DX is the complete surge protection package. Designed specifically for caravans, it offers 1000 joule surge protection, is weatherproof and has a unique outlet tester which warns if plugging into incorrectly wired outlets. Because the S1000DX sits outside your van it protects your whole van, including inverters, battery chargers, tv's, fridges and laptops.

And, whilst a miniature circuit breaker (MCB) and a residual current device (RCD) will protect against overloads and electrocution, they will not protect against power surges. These are caused by distant lightning strikes, power outages and generators running out of fuel.

Most campground cover, product warranties and caravan insurance specifically exclude damage from power surges but with the Ampfibian S1000DX complete surge protection package you will always be covered.

SPECIFICATIONS

- 240V 50Hz 15A 3600W
- 0.8m supply cable
- 1000 Joule protection
- Hanging hook
- Loop for security/locking attachments
- Meets AS/NZS 3120:2011
- IP55 Weatherproof
- Made in Australia



Legally and safely allows your 15A RV power lead to connect to a 10A (domestic) power point.*
*10A maximum allowable output when used



AMPHIBIAN RV-02 MAX 240 VOLT 15 AMP-10 AMP ADAPTOR RCD

039929

Safe and legal connection of a 15A load such as a caravan or other RV to a standard 10A supply when a 15A circuit is unavailable.

FEATURES

- Rugged water resistant design for outdoor use and travel
- Overload and earth leakage (RCD) protection
- Safely connect your 15A device eg. caravan, to domestic outlets
- Cleat to secure outlet lead from accidental disconnections
- 1.8m connection lead flip out hook for hanging
- Clear lids for easy inspection
- Made in Australia
- Designed for Australian conditions

SPECIFICATIONS

- Dimensions: 415mm(l) x 170mm(h) x 110mm(d)
- Overload protection to 10A included
- Suits 9mm diameter extensions cords
- Larger diameter will require some filing of plastic
- Includes Residual Current Device (RCD)



AMPHIBIAN MINI 15A TO 10A POWER ADAPTOR WITH RCD AND OVERLOAD

042424

Safely and legally connect any 15A device such as an RV or heavy duty power tool (eg welder) to a domestic 10A socket. The Ampfibian MINI will cut the power if more than 10A is drawn and also has an in-built Residual Current Device (RCD) which protects against accidental electrocution. The Ampfibian is IP33 rated, but for a fully waterproof solution for RV use, we recommend the Ampfibian MAX (Part no. 039929).

FEATURES

- Designed and made in Australia
- Full Australian standards approved
- IP33 Indoor use recommended



AMPHIBIAN RV-PLUS 15A TO 10A CARAVAN POWER ADAPTOR

043975

The weatherproof Ampfibian RV-PLUS is a dedicated 15A to 10A power adaptor for travellers. It safely and legally connects 15A caravans, RVs, motorhomes and camper trailers to 10A powerpoints. Designed and made in Australia, this tough and compact product eliminates the need for illegally modified 15A leads when plugging in at home.

FEATURES

- 240V 10A 2400W overload protection
- RCD for personal protection
- Certified to comply with AS/NZS-3190 and AS/NZS-3011
- IP55 weather and dust proof
- Power indicator light in socket

GENERATORS

Westinghouse digital inverter generators offer you the ultimate in portable power convenience. Lightweight, fuel efficient and quiet, their mains-quality electrical output can safely power all of your sensitive electronic equipment. They're an essential part of your gear for caravanning and camping and also great for home as a back up power supply. 2 year warranty

Digital Inverter Generator Technology

The pure sine wave power output from Westinghouse digital inverter generators is produced in a three-step computer controlled process, unlike standard generators that use the raw power output from a hardwired alternator. And whereas standard generators run constantly at full speed, inverter generators operate more efficiently by varying their engine speed according to the electrical power demand.



Application Guide

Westinghouse digital inverter generators can individually power most electrical appliances, electrical equipment, power tools and lights that are normally plugged into a standard 240 volt socket.



WESTINGHOUSE IGEN 1200 DIGITAL INVERTER GENERATOR

050094

Running Watts: 1000
Starting Watts: 1200



WESTINGHOUSE IGEN 2500 DIGITAL INVERTER GENERATOR

050096

Running Watts: 2200
Starting Watts: 2500



WESTINGHOUSE IGEN 4500S DIGITAL INVERTER GENERATOR

050097

Running Watts: 3700
Starting Watts: 4500



WESTINGHOUSE 2400 CLASSIC DIGITAL INVERTER GENERATOR

050084

Running Watts: 2100
Starting Watts: 2400



PART NO.	MODEL	MAX OUTPUT KVA	ENGINE SIZE CC	FUEL TANK LITRES	MAX RUNTIME HOURS	MIN NOISE DB(A)	DRY WEIGHT KG
050094	IGEN 1200	1.2	54	2.8	15	52	15
050096	IGEN 2500	2.5	98	4.3	17	52	21.5
050097	IGEN 4500S	4.5	224	13.5	24	52	49.5
050084	2400I CLASSIC	2.4	79	5	24	52	20

WIRING



BUS BAR - 6 WAY - 2 STUD 75A

005060

4mm stainless steel screws for captured wiring connections. 6mm input stud. Tin plated brass. Main Bus 50 amp. Insulated mounting base.

SPECIFICATIONS

- 6 way
- 2 stud



BUS BAR COVER NEGATIVE 6 WAY

038308

6 way bus bar cover.



AUTO WIRE 6MM TWIN

035820 SOLD PER METRE

004129 30M ROLL

Sold per metre or 30m roll.

SPECIFICATIONS

- Bulk 30m roll
- Twin 6mm wire



CABLE 2 CORE SHEATH

004131 6MM X100M ROLL

004124 4MM X100M ROLL



CORRUGATED SPLIT TUBE

004147 10MM X10M

004150 13MM X10M

Corrugated tubing offers the ideal solution for keeping lengths of cable neatly and professionally organised. Provides protection from abrasion, punctures, vibration as well as automotive fluids and high operating temperatures.

SPECIFICATIONS

- Length 10m
- Black

CHARGERS & INVERTERS



HIDDEN WIRELESS CHARGER

050816

Engineered to be installed under the surface of a bench in your caravan, leaving the top surface un-cluttered, provides additional bench space and did we mention no charging cables? This innovative new product can be installed under tables, cabinets, consoles or work tops, working directly with 12/24V system.

FEATURES

- The world's first 12/24V wireless waterproof Qi™ certified charger
- UV stable
- High friction non-slip pad
- Marine grade materials
- ROKK wireless is designed to work with most slimline phone cases up to 5mm
- Foreign object detection system (will only recognize and charge phones with Qi charging capabilities)

SPECIFICATIONS

- Input voltage range : 10-30V DC (12/24V system)
- Input current max: 1.5A
- Output power: 5W (5V, 1A)
- Standby current draw: < 0.03W
- Waterproof rating: IPX6 front and back

BATTERY CHARGER 7000/12 CTEK

003789

The CTEK MXS 7.0 Battery Charger is perfect for charging the larger batteries that you find in RVs, boats caravans and cars.

The CTEK MXS 7.0 Battery Charger is a fully automatic 8-step charger that delivers 7A to 12V batteries from 14-150Ah and is also suitable for maintenance charging up to 225Ah. It includes battery diagnosis to establish whether your battery can receive and retain a charge, a special Recond mode for restoring and reconditioning stratified and deeply discharged batteries, a winter program for charging in cold weather and an AGM battery option. The MXS 7.0 can even be used as a power supply source for 12V equipment up to 7A.

FEATURES

- Fully automatic 'connect and forget' charging
- AGM, Normal and Recond programs
- Charges batteries up to 150Ah
- Power supply for 12V equipment up to 7A
- 5-year warranty
- IP65

SPECIFICATIONS

- Weight: 0.95 kg
- Dimensions: 191(l) x 89(w) x 48(h)mm
- Amps: 7A
- Volts: 12V
- Vehicle Type: CAR, Caravan & Motorhomes, Motor Bike
- 12V WET, MF, AGM, GEL batteries



WAECO INVERTER 150 WATT CAN SIZE BATTERY/OVERLOAD PROTECTION

003814

Perfectly round, this can size inverter is easily accessible and can be placed in the vehicle's drink holder.

FEATURES

- Firm and secure hold in the vehicle's cup holder
- Mobile energy for 240V low-power consumers
- Thermal overload protection, electronic short circuit protection, automatic low voltage shutdown

SPECIFICATIONS

- Dimensions: 66mm(diam) x 173mm(l)
- Peak/Continuous Power: 250/150W
- Input Voltage: 12V DC (10 to 15V)130mm(d)



BATTERY CHARGER CTEK MXS 5.0

040192

The charger can solve a broad range of battery-related problems and is the perfect charger for those with high demands. The CTEK MXS 5.0 Battery Charger 12V 5A offers features such as battery diagnosis that shows if a battery can receive and retain a charge, a special reconditioning function that restores stratified and deeply discharged batteries, unique maintenance charging, a mode for optimised charging during cold winter days and the charging of demanding AGM batteries (i.e. Optima). The unique display allows the user to follow the entire charging process.

The MXS 5.0 is a fully automatic 8-step charger that delivers selectable 0.8A or 5A to 12V batteries from 1,2-110Ah and is suitable for maintenance charging up to 160Ah. The charger is IP 65 classified (splash and dust proof), designed to protect vehicle electronics and non-sparking, reverse polarity protected and short-circuit proof. It is delivered with a 5-year warranty.

FEATURES

- Fully automatic 'connect and forget' 8 step 12V charging
- Smaller battery, normal battery, AGM and Recond programs
- Built in automatic temperature compensation
- Patented float/pulse maintenance for batteries up to

- 160Ah
- 5-year warranty

SPECIFICATIONS

- Weight: 0.6 kg
- Dimensions: 168(l) x 65(w) x 38(h)





CHASSIS

- Axles..... 113
- Brakes 115
- Hubs, Drums, Discs..... 116
- Mudguards & Wheel Equipment 117
- Jockey Wheels 118
- Jockey Wheels Spare Parts..... 121
- Corner Steadies 121
- Couplings 123
- Springs..... 126
- Vehicle Steps 128
- Caravan Movers..... 129

AXLES



SUIT HOLDEN BEARINGS 40MM SQUARE 1000KG EACH

- 036015 1397MM LM MACHINED PROFILE
- 036022 1600MM LM MACHINED PROFILE
- 036024 1650MM LM MACHINED PROFILE
- 036026 1702MM LM MACHINED PROFILE
- 036027 1727MM LM MACHINED PROFILE
- 036031 1829MM LM MACHINED PROFILE
- 036032 1854MM LM MACHINED PROFILE
- 036036 1956MM LM MACHINED PROFILE
- 036039 2032MM LM MACHINED PROFILE
- 036045 2184MM LM MACHINED PROFILE
- 036051 2337MM LM MACHINED PROFILE
- 036055 2438MM LM MACHINED PROFILE



SUIT FORD (SLIMLINE) BEARINGS 45MM SQUARE 1450KG EACH

- 036067 1905MM SLIMLINE MACHINED PROFILE
- 036069 1980MM SLIMLINE MACHINED PROFILE
- 036071 2108MM SLIMLINE MACHINED PROFILE
- 036072 2185MM SLIMLINE MACHINED PROFILE
- 036074 2260MM SLIMLINE MACHINED PROFILE
- 036076 2362MM SLIMLINE MACHINED PROFILE
- 036077 2440MM SLIMLINE MACHINED PROFILE



STUB AXLES SUIT HOLDEN BEARINGS

- 036079 40MM ROUND 250MM O/A
- 036084 40MM SQUARE 200MM O/A
- 036085 40MM SQUARE 250MM O/A

STUB AXLES SUIT FORD (SLIMLINE) BEARINGS

- 036083 45MM ROUND 280MM O/A
- 036086 45MM SQUARE 305MM O/A



AXLE FLAT WASHER 3/4IDX1&1/2

006550



AXLE NUT PIN & WASHER KIT

050195



AXLE NUT/PIN/WASHER SKIN PAK X2

050108



DUST CAP METAL SUIT 1.5/2T AXLE, 2 1/2IN

006569



OIL SEAL HOLDEN DOUBLE LIP STUB AXLE (2.328" X 1.437" X 0.4")

006558

Oil Seal 609 Suit Standard Bearing. These fit the HT holden bearings, when used on a standard axle.



OIL SEAL 2 TONNE

038134

AL-KO Oil Seal 494015, Suit heavy duty axles with 2 tonne and 3 tonne capacity.



OIL SEAL SLIMLINE

006559

Oil Seal 610 Suit slimline Bearing, Slimline seal suits heavy duty axle with Ford bearings.

BEARINGS



ON ROAD BEARING KITS

(Inner bearing, outer bearing, grease seal, grease cap)

- 036183 LM HOLDEN CHINA
- 006563 LM HOLDEN JAPAN
- 051353 LM HOLDEN CHINA ARK
- 050118 S/L (FORD) CHINA
- 006565 S/L (FORD) JAPAN
- 006562 COMPOSITE JAPAN
- 006560 PARALLEL JAPAN
- 050127 2 TONNE JAPAN



MARINE BEARING KITS WITH MARINE SEAL

(Inner bearing, outer bearing, grease seal, grease cap)

- 050117 LM HOLDEN CHINA
- 050119 LM HOLDEN JAPAN
- 051348 LM HOLDEN CHINA ARK
- 050125 S/L (FORD) CHINA



OUTER BEARING

050276 USA BEARING

FEATURES

- L44649
- Often used as the outer bearing on imported USA boat trailers



H26 GREASE CAPS X 2 SKIN PACK

050136

- Housing diameter: 45.2mm
- Suits LM & SL Bearing Hubs/Drums
- Genuine Alko replacement part



LUBRIMATIC MARINE GREASE

006576

Recommended for use on all boat trailers.



HIGH TEMP BEARING GREASE 500G

006579

BRAKES



BRAKE PLATES AND SPARE PARTS

- 006340 BRAKE ASSY PLATE RIGHT HAND, MECHANICAL 9"
- 006341 BRAKE ASSY PLATE LEFT HAND, MECHANICAL 9"
- 036113 BRAKE ASSY PLATE 250X56 ELECTRICAL, TRAILTECH RIGHT HAND
- 036114 BRAKE ASSY PLATE 250X56 ELECTRICAL, TRAILTECH LEFT HAND
- 006333 BRAKE ASSY PLATE RIGHT HAND AL-KO
- 006334 BRAKE ASSY PLATE LEFT HAND AL-KO
- 036112 BRAKE ASSY PLATE ELECTRICAL RIGHT HAND, OFF ROAD 10"
- 036111 BRAKE ASSY PLATE ELECTRICAL LEFT HAND, OFF ROAD 10"
- 033582 BRAKE ASSY PLATE ELECTRICAL SUIT 12" - PR LH/RH
- 034962 12" BRAKE ASSY PLATE RIGHT HAND OFF ROAD
- 006336 ADAPTOR PLATE MOUNT NUT ONLY 7/16" UNF
- 006395 ADAPTOR PLATE SUIT 40MM RND HOLE, FOR ELECT/MECH BACKING PLATE
- 006397 ADAPTOR PLATE SUIT 45MM RND HOLE, FOR ELECT/MECH

Brake assembly - Electric, LEFT, 250 x 56mm (10 Inch x 2 1/4 Inch) AL-KO, OFFROAD. They must be ordered for LEFT or RIGHT hand side of caravan / trailer. The kerb side is the LEFT side and does not include the drum which is ordered separately to match the stud pattern required.

FEATURES

- These AL-KO OFFROAD brake assembly plates come complete with magnet and mechanical park brake lever, and brake shoes. The 4 mounting bolts are 72mm apart (centre/centre)



HYDRAULIC BRAKE SPARE PARTS

- 034170 HYDRAULIC DISC BRAKE CALIPER AL-KO DACROMET COATED
- 036153 HYD DISC BRAKE CALIPER TRIGG A200M



MECH DISC BRAKE PAD

- 043162 MECH BRAKE PADS ARK (PR)
- 050111 MECH BRAKE PADS AL-KO (PR)

Will also suit Trigg hydraulic calipers



AL-KO CALIPER N/S BRAKE PAD

051123

FEATURES

- 'Bolt On' style pad
- Suits the newer AL-KO mechanical calipers
- Sold ea



BRAKE SHOES

- 036133 BRAKE SHOE 9"X45MM EA
- 006390 BRAKE SHOE 10"X 2 1/4" PRIMARY EA
- 006391 BRAKE SHOE 10"X 2 1/4"SECONDARY EA
- 040625 BRAKE SHOE 10" EL PR/SET SUIT 1 X WHEEL
- 034871 BRAKE SHOE 12" PRIMARY AL-KO EA
- 034872 BRAKE SHOE 12" SECONDARY AL-KO EA

Brake Shoe 230 X 45mm, Mechanical. Please NOTE: this is for a single shoe only, each wheel requires two shoes, but the leading and trailing shoes are identical for this type of brake.



HYD DISC BRAKE PAD TROJAN AL-KO

341103

036162

Sold Individually. 2 required per caliper



MECHANICAL DISC BRAKE CALIPERS

- 036145 MECHANICAL DISC BRAKE CALIPER
- 036147 MECHANICAL DISC BRAKE ADAPTOR PLATE 40MM AL-KO VERSION
- 036158 MECHANICAL DISC CALIPER BOLT
- 036159 MECHANICAL DISC CALIPER RETAINING SPRING
- 036163 MECHANICAL DISC CALIPER MOUNTING BUSH



BRAKE MAGNETS

- 006384 BRAKE MAGNET 10" SUITS HAYES AND AL-KO
- 006388 LEFT HAND OFFROAD AL-KO 10"
- 006389 RIGHT HAND OFFROAD AL-KO 10"
- 034873 BRAKE MAGNET 12IN OVAL AL-KO
- 051589 BRAKE MAGNET TO SUIT 12"
- 051590 12" OFF ROAD L/H
- 051591 12" OFF ROAD R/H

Brake Magnet, Dexter, AL-KO, Oval Type, spring & Clip. Weak or noisy brakes are often caused by uneven or excessive wear on the rubbing surface of the magnet. For balanced braking, the opposing brake magnet should be replaced at the same time. Price is for one Electric brake magnet.



CLIP FOR KELSEY OVAL MAGNET

006385

Magnet Clip Suit Oval Type, holds the magnet onto the small centre shaft in the electric brakes.

HUBS/DRUMS/DISCS



HUB/DRUMS

- 042731 BOXED HUB DRUM 9" MECH FORD
- 042734 BOXED H/DRM 9" MECH FRD S/L
- 050205 BOXED H/DRUM 10" HT JAP LM
- 042712 BOXED ELECTRIC FORD 10" C/W STUDS ONLY
- 042738 BOXED ELECTRIC FORD 10" RETAIL BOXED, C/W STUDS, NUTS JAP SLIMLINE BEARINGS
- 042714 BOXED ELECTRIC LANDCRUISER 10" 6 STUD NO NUTS OR BEARINGS S/PARALLEL BEARINGS

Brake Hub Drum - Photo is representative only as numbers and position of studs vary. Price is for one side only. They fit either left or right.

- 042737 BOXED ELECTRIC LANDCRUISER 10" 6 STUD RETAIL BOXED, C/W STUDS, NUTS JAP SLIMLINE BEARINGS

Brake Hub Drum - Landcruiser 6 Stud, suit 250mm AL-KO electric brake assembly. Price is for one side only. They fit either left or right.



WHEEL AND TYRE SPARE PARTS

- 036186 WHEEL STUD LONG SPLINE, 1/2"IND - 55MM SPEC

SPECIFICATIONS

- Main thread is 35mm long, Thread plus spline in total is 55mm Spline outer dia is 15-15.5mm. 1/2" UNF

- 036187 WHEEL STUD SHORT SPLINE, 1/2"IND - 50MM SPEC

SPECIFICATIONS

The combined spline and thread is 50mm The spline is 12mm long.

- 006635 WHEEL STUD SUIT 7/16"X1&5/8" HOLDEN

SPECIFICATIONS

- Total length of spline and thread is 38mm
- Outer spline dia 13.5mm
- Outside of thread measures 11mm

- 006636 WHEEL STUD SUIT 1/2"UNFX1&5/8" FORD

- 006638 WHEEL NUT - SUIT HOLDEN 7/16"

- 006639 WHEEL NUT - SUIT FORD 1/2"



MECHANICAL DISC BRAKES

- 036150 MECH DISC BRAKE HUB FORD BLACK
- 036166 MECH DISC BRAKE HUB HT GAL- LM BEARINGS
- 036167 MECH DISC BRAKE HUB FORD GAL - LM BEARINGS
- 036168 MECH DISC BRAKE HUB HQ GAL - LM BEARINGS
- 038754 MECHANICAL DISC BRAKE HUB HT HOLDEN BOXED GALVANISED C/W SLIMLINE BEARINGS
- 038755 MECHANICAL DISC BRAKE HUB - FORD BOXED GALVANISED C/W SLIMLINE BEARINGS



PLATED STUD KIT

- 050131 PLATED TRAILER 7/16 NUT KIT PKT 5
- 050134 PLATED TRAILER 1/2 NUT KIT PKT 5
- 050132 PLATED 7/16 TRAILER STUD KIT PKT 5
- 050130 PLATED TRAILER STUD & NUT KIT PKT 5 (7/16")
- 050135 PLATED TRAILER STUD & NUT KIT PKT 5 (1/2")



TRAILER STUD & NUT KIT 1/2 UNF

- 050129

SPECIFICATIONS

- Natural finish
- Pkt of 5
- 1/2" stud & nut



- TRAILER STUD & NUT KIT 7/16 UNF
- 050128
- Specifications
- Natural finish
- Pkt of 5
- 7/16" stud & nut



HUB KITS - GALVANISED

- 050197 NON BRAKED HUB HT (SMALL FLANGED) GALV SUIT O/S 9" ALLOY WHEELS - LM BEARINGS
- 036102 NON BRAKED HUB HT GALV - LM BEARINGS
- 040629 HUB KIT GAL HT CH S/L BEARING
- 042727 NONBRAKED HUB FORD GALV - LM BEARINGS
- 050206 NON BRAKED HIB FORD GALV - S/L (FORD) BEARINGS

Non Braked Hub - HT Holden, galvanised. Includes cones, bearings, seal and cap.

SPECIFICATIONS

- Non-braked hub including 5 studs
- 5 wheel nuts
- 1 x Outer Cone/ Bearing
- 1 x Cup
- 1 x Inner Cone/ Bearing
- 1 x Cup
- 1 x 28550 Rear Grease Seal
- 1 x DC1 Grease Cap



NON BRAKED HUBS NATURAL FINISH

- 036088 MINI HOLDEN BEARINGS - 4 STUD
- 038751 HQ LM (HOLDEN) BEARINGS
- 051347 FORD LM (HOLDEN) BEARINGS - ARK
- 042720 FORD LM HOLDEN BEARINGS
- 036101 SUIT LANDCRUISER 6 STUD C/W STUDS NUTS AND HOLDEN LM BEARINGS
- 036096 NON BRAKED HUB SUIT FORD S/L
- 050196 L/C S/L LANDCRUISER S/L (FORD) BEARINGS

MUDGUARDS & WHEEL EQUIPMENT



WHEEL ARCH

006543 WHEEL ARCH 30IN S6L GALV

006544 WHEEL ARCH TANDEM GALV



MUD GUARD - POLY PLASTIC

Strong with steps on both sides as well as on top. Mud flaps, brackets not included.

036283 MUDGUARD POLY SMALL 10" WHITE

036284 MUDGUARD POLY SMALL 10" SILVER

036285 MUDGUARD POLY MED 13" WHITE

036286 MUDGUARD POLY MED 13" SILVER

036287 MUDGUARD POLY LARGE 14" WHITE

036288 MUDGUARD POLY LARGE 14" SILVER

043662 MUDGUARD BRACKET 23.5 X 7.5

051398 MUDGUARD POLY SMALL 10" BLACK

051399 MUDGUARD POLY MED 13" BLACK

051400 MUDGUARD POLY LARGE 14" BLACK



ALLOY WHEEL (VELOX)

036470 HUB MOUNT WITH TYRE 10"

036462 BEARING MOUNT WITH TYRE 8"



WHEELS

036455 STEEL ROAD WHEEL, SUIT HOLDEN HT14" SUNRAYSLIA BLACK

Sunraysia Black wheel rim, HT Holden, 14" x 6". These black painted sunraysia steel rims suit the HT stud pattern.

SPECIFICATIONS

- Material: Painted steel rims
- Size: 14 inch dia, 6 inch wide
- Suit: Holden HT, HG, HK
- PCD: 4 1/4 inch (107.95mm)
- Adjacent Studs: 2 1/2 inches (63.45mm) between centres.
- Suit Studs: 5 x 7/16 inch.
- Colour: Black

006615 STEEL ROAD WHEEL, SUIT FORD 14" X 6" SUNRAYSLIA WHITE

Sunraysia White Road Wheel Ford, 14 Inch x 6 inch. This steel rim suits the ford stud pattern and is a popular replacement for the standard rims.

SPECIFICATIONS

- Material: Painted steel rims
- Size: 14 inch dia, 6 inch wide
- Suit: Ford
- PCD: 4 1/2 inch (114.30mm)
- Adjacent Studs: 2 5/8 inches (67.18mm) between centres
- Suit Studs: 5 x 1/2 inch
- Colour: White

038357 STEEL ROAD WHEEL, SUIT HOLDEN HR 330MM BLACK

036452 STEEL ROAD WHEEL, SUIT HOLDEN HQ 355MM BLACK

Steel Road wheel rim, HQ Holden, 14 x 6 inch. These black painted steel suit the HQ stub pattern.

SPECIFICATIONS

- Material: Painted steel rims
- Size: 14 inch dia, 5.5 inch wide
- THESE ARE NOT SUITABLE FOR YOUR HOLDEN!
- PCD: 4 3/4 inch (120.65mm)
- Colour: Black

043161 13" WHITE POWDER COATED WHEEL TO SUIT FORD WITH 155/80 TYRE RATED AT 437KG

043160 GALVANIZED 13" WHEEL WITH ALL TERRAIN TREAD FOR HT/FORD 165R13C TYRE (MULTI FIT) RATED AT 670KG



MULTI-FIT SPARE WHEEL CARRIER

051361

SPECIFICATIONS

- Suits 4,5 & 6 stud wheels
- Suits drawbar size 50-100mm
- Locking facility secures wheel and prevent theft

000512 SPARE WHEEL MOUNT BOLT ON - STRAIGHT

Spare Wheel Carrier Bolt On. The flat base includes 2 x 125mm u-bolts which cover up to 100mm of bumper thickness. If using on an A-frame the wheel will be inline or at 90 degrees to the A-Frame. These are not recommended for LARGE 4WD wheels.

SPECIFICATIONS

- The upright is 395mm from the bumper top, to the centreline of the wheel mount
- The Wheel backing plate is 160mm offset from the centreline of the upright. It has 20mm centre mounting bolt with provision to accept a padlock single locating pin that fits thru one wheel stud hole (any stud pattern).
- The steel profile is 65mm x 35mm.



000512

JOCKEY WHEELS



SWIVEL JOCKEY WHEELS WITH SMALL CLAMP S/50 X 50 FRAME BOLT OR WELD ON

036244 6" WHEEL
006416 8" WHEEL

FEATURES

- Swivel bracket allows the jockey wheel to stay permanently attached.
- No need to remove for storage
- Simple swing away action for travelling position
- Angle tube prevents rotation when stowed
- Large heavy duty wheel for easy maneuvering on soft or uneven surfaces
- Zinc coated for lasting protection

8" SPECIFICATIONS

- Static Capacity: 400kg
- Wheel Size: 200mm (8") solid tyre
- Weight: 8.5kg
- Max Lift / extension: 250mm
- Minimum Ground Clearance(G1): 310mm (from centre of drawbar)
- Maximum Ground Clearance(G2): 560mm (from centre of drawbar)
- Overall Shaft Height Open: 820mm
- Overall Shaft Height Closed: 570mm
- Finish: Zinc Plated
- Clamp: Small Swivel Bracket - Bolt on (u-bolts or bolts not included)



JOCKEY STANDS - VARIOUS

039992 ARK ADJUSTABLE STAND WITH SWIVEL BRACKET - SIDE WINDER

006445 EASYLIFT ADJ STAND NO CLAMP 27"

006450 AL-KO ADJUSTABLE STAND AND CLAMP 14"

Adjustable jockey stand with flat base. These come with the clamp as shown.

SPECIFICATIONS

- Outside tube is 355mm.
- Maximum lift from ground is 500mm

006451 AL-KO ADJUSTABLE STAND AND CLAMP 20"

- Adjustable jockey stand with flat base and clamp. Outside tube is 510mm.

SPECIFICATIONS

- Zinc Coated
- Outside tube is 510mm
- Extends 240mm
- 50mm dia clamp supplied

JOCKEY WHEEL W/CLAMP OR NO CLAMP

006402 JOCKEY WHEEL 6X2IN STD W/CLAMP FEATURES

- Included AL-KO Standard Clamp - this can be bolted or welded on. (Bolts not included)
- Zinc coated for lasting protection

SPECIFICATIONS

- Static Capacity: 400kg. Weight: 5.5kg
- Wheel Size: 150mm (6") solid tyre
- Max Lift / extension: 265mm
- Minimum Ground Clearance(G1): 202mm (from centre of drawbar)
- Maximum Ground Clearance(G2): 649mm (from centre of drawbar)
- Overall Shaft Height Open: 772mm
- Overall Shaft Height Closed: 507mm
- Finish: Zinc Plated
- Clamp: Standard bolt/weld on (bolts not included)



006404 JOCKEY WHEEL 6X2" STD NO CLAMP

006408 JOCKEY WHEEL 8X2 W/STD CLAMP

FEATURES

- Large heavy duty wheel for easy maneuvering on soft or uneven surfaces
- Included AL-KO Standard Clamp - this can bolted or welded on. (Bolts not included)
- Zinc coated for lasting protection

SPECIFICATIONS

- Static Capacity: 400kg. Weight: 7kg
- Wheel Size: 200mm (8") solid tyre
- Max Lift / extension: 265mm
- Minimum Ground Clearance(G1): 262mm (from centre of drawbar)
- Maximum Ground Clearance(G2): 697mm (from centre of drawbar)
- Overall Shaft Height Open: 832mm
- Overall Shaft Height Closed: 567mm
- Finish: Zinc Plated
- Clamp: Standard bolt/weld on (bolts not included)

038556 AL-KO STANDARD WITH CLAMP 350MM X 410MM

Wide, solid rubber wheel for easy maneuvering. Includes Sto clamp

042352 AL-KO EXTRA HEIGHT NO CLAMP 8" 200MM

FEATURES

- Large heavy duty wheel for easy maneuvering on soft or uneven surfaces
- Extra height great of off road caravans and camper trailers
- Zinc coated for lasting protection

SPECIFICATIONS

- Static Capacity: 400kg. Weight: 7kg
- Wheel Size: 200mm (8") solid tyre
- Max Lift / Extension: 265mm
- Minimum Ground Clearance(G1): 370mm (from centre of drawbar)
- Maximum Ground Clearance(G2): 767mm (from centre of drawbar)
- Overall Height Open: 995mm
- Overall Height Closed: 730mm
- Finish: Zinc Plated
- Clamp: None Supplied - see related items below for Standard or Wide Clamps



SWIVEL JOCKEY WHEELS WITH LARGE CLAMP

006406 JOCKEY WHEEL 6IN W LGE SWIVEL

006410 JOCKEY WHEEL 8IN W LGE SWIVEL

038561 JOCKEY WHEEL 350X410MM W/ SWIV

Attached swivel clamp can be bolted to 50/75/100mm drawbars.



ARK JOCKEY WHEELS

044987 ARK SPARE HANDLE

051340 ARK 8" JOCKEY WHEEL

051341 ARK 10" JOCKEY WHEEL

051342 ARK 10' JOCKEY WHEEL

051343 ARK 6" JOCKEY WHEEL

051344 ARK 8" JOCKEY WHEEL PREMIUM

051346 ARK 8" JOCKEY WHEEL

051358 ARK 6" ECONOMY JOCKEY WHEEL

051362 ARK 10" JOCKEY WHEEL

051363 ARK 10" JOCKEY WHEEL

051339 ARK 6" JOCKEY WHEEL

051351 ARK EZIMOVER JOCKEY WHEEL

051356 ARK 6" JOCKEY WHEEL

051366 ARK 8' JOCKEY WHEEL HEAVY DUTY

051368 ARK JOCKEY STAND 350KG

051369 ARK JOCKEY STAND 350KG

051360 ARK 6" JOCKEY WHEEL PREMIUM

051370 ARK 8" JOCKEY WHEEL



JOCKEY WHEEL TWIN WHEEL HEAVY DUTY WITH SOLID WHEELS, INC CLAMP LOAD CAPACITY 1000KG

042292



TRAIL-A-MATE HYDRAULIC JOCKEY WHEEL AND JACK

000417 TRAIL-A-MATE JOCKEY WHEEL, HYDRAULIC, LIFTING CAPACITY 1000KG

A hydraulic jockey wheel that converts in to a jack when you need it. You simply swap the wheel for a solid base plate. The key features of the Trail-A-Mate are as follows:

- Capacity - WLL 1,000kg / ATM 2,900kg
- Versatility - Easily converts from a jockey wheel to a jack
- Ease of Use - Being hydraulic it takes very little effort to operate
- Safety - Fully complies with the Australian mandatory safety standards (2693:2007) It has many applications and uses such as caravanning, horse floats, trailers, food vans, motorhomes.

FEATURES

- For stress free raising and lowering of caravans, boats and trailers
- Safety nonslip lugs built in
- No need to climb under the vehicle to jack it up
- Suitable for most jockey wheel brackets
- Both a jack and jockey wheel
- Trail-A-Mate - safe working load of 1000kg when base is fitted
- Trail-A-Mate II - safe working load of 1500kg when base is fitted

040981 TRAIL-A-MATE MKII JACK, HYDRAULIC, LIFTING CAP 1500KG NO WHEEL (JACK ONLY)

Trail-A-Mate MkII is a hydraulic caravan jack designed to lift larger and heavier caravans than the original Trail-A-Mate Jockey Wheel/Jack. The outside diameter is 60mm. There is an optional 60mm A-Frame clamp

FEATURES

- Requires 60mm clamp to be purchased separately if used on the A-Frame.
- Does NOT fit standard 50mm clamp
- Easy to Use - Being hydraulic it takes very little effort to operate
- Safety - Fully complies with the Australian mandatory safety standards (2693:2007)

SPECIFICATIONS

- Capacity: 1500kg /ATM 3500kg
- Comes with detachable flat base.
- Comes with jacking clamp as per the photo above.

000418 TRAIL-A-MATE BASE PLATE

000420 TRAIL-A-MATE LIFTING CLAMP

000422 TRAIL-A-MATE JACK BRACKET ONLY

000427 TRAIL-A-MATE SERVICE KIT

000429 TRAIL-A-MATE JACK HANDLE ONLY

042460 TRAIL-A-MATE CLAMP 60MM

043244 TRAIL-A-MATE SERVICE KIT FOR MKII

044976 TRAIL-A-MATE WHEEL

050264 TRAIL-A-MATE LOCK

051442 TRAIL A MATE COVER



JOCKEY WHEEL CLAMP

050278

AL-KO premium extra wide clamp for extra stability and strength.



LARGE JOCKEY WHEEL HOLDER

050029

SPECIFICATIONS

- Size: 204 x 204 x 35mm
- Can be pegged to the ground suits 6", 8" and 10" jockey wheels
- Stops the jockey wheel sinking into soft ground



ARK SPARE JOCKEY WHEEL ONLY

051297

Powder coated solid rubber wheel. 12mm shaft size



POWER MOVER

000464 POWER MOVER HANDLE ONLY 038543 POWER MOVER WITH SOLID WHEEL (AL-KO)

A most efficient caravan mover featuring original dual pawl ratchet system. This model can be mounted on either side of the drawbar, thereby allowing maximum maneuverability. It is fitted to the normal jockey wheel bracket and can be wound up to a height of 840mm.

FEATURES

- Ratchet jockey wheel
- Assists the manual movement of a caravan or trailer
- Includes handle and clamp
- 250mm diam wheel

JOCKEY WHEEL SIDE WIND & WIDE CLAMP

050151

This jockey wheel is part of the premium range and comes with a side-winder which allows for unrestricted movement, top-wind units can be obstructed by items mounted on your drawbar. This is a jockey wheel is perfect for a huge range of applications as this jockey wheel has 4 clamping positions and has an integrated gearbox that provides an effortless winding with its static capacity for up to 400kg.



JOCKEY WHEEL RECEIVER RUBBER

000410

Jockey Wheel Receiver, Rubber. Spread the load and stop the jockey wheel rolling. This is made of strong firm rubber similar to the rubber on jockey wheels. Suits 150mm wheels

OFF ROAD JOCKEY WHEEL

044576 500KG

The Extreme Off Road Series Jockey Wheel is probably the toughest, most advanced Jockey Wheel in Australia today. But not only is it tough, it's also versatile – with multiple height options, a highly maneuverable trailing yoke design and 5 different yoke locking positions. Makes moving easy both on and off road.

FEATURES

- Side-winding handle
- Easier raising & lowering of trailers/caravans - away from stone guards, toolboxes or jerry can holders
- Magnetic, removable handle ensures safe stowage and prevents damage in offroad situations
- Increases load carrying capacity and eliminates the likelihood of “bend” under weight
- 4 x adjustable height positions
- 250mm height adjustability at each of the 4 positions, whilst maintaining a central swivel point for extra strength
 - Heavy duty swivel clamp
- 4 bolt pivot point ensures no more bowing under weight
- Suitable for 75mm, 100mm, 130mm and 150mm drawbars
- Comes with mounting hardware - no more welding onto drawbars
- Wheel pivots easily, even under heavy load or on soft ground
- Dual wheel with sealed bearings & offroad tread
- Increases offroad grip and spreads the load
- Variable yoke lock
- Rust resistant finish

044577 OFF ROAD JOCKEY WHEEL 750KG

These jockey wheels have been designed for tough Australian offroad conditions with their solid construction and 750kg rating. The versatile design includes 4 adjustable height positions, a heavy duty swivel clamp, 5 yoke locking positions, and it can be mounted on 75mm, 100mm, 130mm or 150mm drawbars. The dual wheels provide a wider footprint, spreading the load and increasing offroad grip even on soft surfaces. The trailing yoke design provides maximum maneuverability, pivoting easily even under heavy loads.

FEATURES

- Heavy duty swivel clamp
- 4 adjustable height positions
- Dual wheel, trailing yoke design for maximum maneuverability
- Magnetic, removable winder handle
- Multiple wheel locking positions for stowage
- Rust resistant finish

SPECIFICATIONS

- Static Capacity: 750kg
- Wheel Size: Dual 200mm (8”) solid tyre
- Weight: 20kg
- Max Lift / extension: 250mm
- Minimum Ground Clearance: 285mm (from centre of drawbar)
- Maximum Ground Clearance: 710mm (from centre of drawbar)
- Overall Height Open: 895mm
- Overall Height Closed: 645mm
- Finish: Zinc Plated
- Clamp: Swivel Bracket - includes mounting hardware to suit 75mm, 100mm, 130mm or 150mm drawbars

ALSO AVAILABLE

051096 OFF ROAD JOCKEY WHEEL 750KG IN BLACK



JOCKEY WHEELS SPARE PARTS

CODE	PRODUCT NAME	036247	UBOLT KIT SUIT AL-KO J/WHEEL 75W X 75L
006429	RUBBER WHEEL AL-KO SUIT 8" X 2" X 1/2" SOLID STEEL WHEEL WITH RUBBER TYRE	006438	HANDLE ONLY FOR JOCKEY WHEEL AL-KO LOOSE
043250	CLAMP ONLY FOR JOCKEY WHEEL CAMEC	006424	PULLING HANDLE AL-KO FOR MOVING THE VAN ABOUT
050150	J/WHEEL CLAMP HANDLE SKIN PACK	036264	HANDLE ONLY JOCKEY WHEEL EASYLIFT
050144	J/WHEEL HANDLE SKIN PACK ROLL PIN STYLE	006440	THRUST BEARING JOCKEY WHEEL LOOSE
050143	J/WHEEL HANDLE SKINPACK GRUB SCREW STYLE	006425	BOLT AND WASHER KIT SUIT AL-KO 1/2" JOCKEY WHEEL CLAMP LOOSE
050149	J/WHEEL THRUST BEARING SKIN PA	006437	RUBBER TUBE ONLY SUIT 4.10 X 3.50
006418	CLAMP FOR JOCKEY WHEEL SINGLE	036266	RUBBER TYRE ONLY SUIT 4.10 X 3.50 X 4 PLY
036263	SWIVEL CLAMP NO WELD REQ AL-KO	006428	RUBBER WHEEL 6X2X1/2IN SOLID
039993	CLAMP FOR JOCKEY WHEEL BOLT-ON STYLE		
036246	UBOLT KIT SUIT AL-KO JOCKEY WHEEL 100W X 75L		

CORNER STEADIES



AL-KO CORNER STEADY DROP DOWN

051185

SPECIFICATIONS

- 590mm open length
- Black finish



AL-KO CORNER STEADY DROP DOWN

051186

SPECIFICATIONS

- 740mm open length
- Black finish



LEG DROP DOWN 840MM ALKO BLACK

051716

The ALKO Black 590mm Drop Down Corner Steady is designed to stabilize your trailer or caravan whilst stationary, whether the ground is hard or soft, you can rely on this corner steady for supreme stability.

SPECIFICATIONS

- Corner steadies are not designed to be used as a jack or as the method of lifting the trailer off the ground. They are designed to stabilize the trailer or caravan when stationary.
- The Alko leg comes with a mounting plate which can be welded on.
- Winder handle not included.



ADJUSTABLE CORNER STEADIES

Ensure the caravan or trailer is secure and even when stationary. Adjustable corner steadies are available in positive drive wind-down or dropdown models. Corner steadies are not designed as a jack and must not be used for this purpose.

006476 ADJUSTABLE LEG FRONT AL-KO SUIT HEX HANDLE 500MM LENGTH

AL-KO wind down legs have a solid hex nut for positive connection of winder (not included). These will extend 500mm vertically so will give an adequate range on most standard clearance caravans / trailers.

006457 ADJUSTABLE LEG FRONT DYMWOOD SUIT SLOTTED HANDLE 18" LENGTH

006469 ADJUSTABLE LEG FRONT MANUTECH SUIT HEX HANDLE 500MM LENGTH

006470 ADJUSTABLE LEG FRONT MANUTECH SUIT SLOTTED HANDLE 500MM LENGTH

006473 ADJUSTABLE LEG REAR MANUTECH SUIT SLOTTED HANDLE 500MM LENGTH

006477 ADJUSTABLE LEG FRONT AL-KO SUIT HEX HANDLE 600MM LENGTH

006478 ADJUSTABLE LEG FRONT AL-KO SUIT HEX HANDLE 700MM LENGTH

006479 ADJUSTABLE LEG REAR AL-KO SUIT HEX HANDLE 500MM LENGTH

006480 ADJUSTABLE LEG REAR AL-KO SUIT HEX HANDLE 600MM LENGTH

006481 ADJUSTABLE LEG GALV AL-KO SUIT HEX HANDLE 500MM TOP MOUNT - SUIT JAYCO

006482 ADJUSTABLE LEG GALV AL-KO SUIT HEX HANDLE 700MM TOP MOUNT - SUIT JAYCO

006452 RUBBER WHEEL FOR BACK LEG 3IN

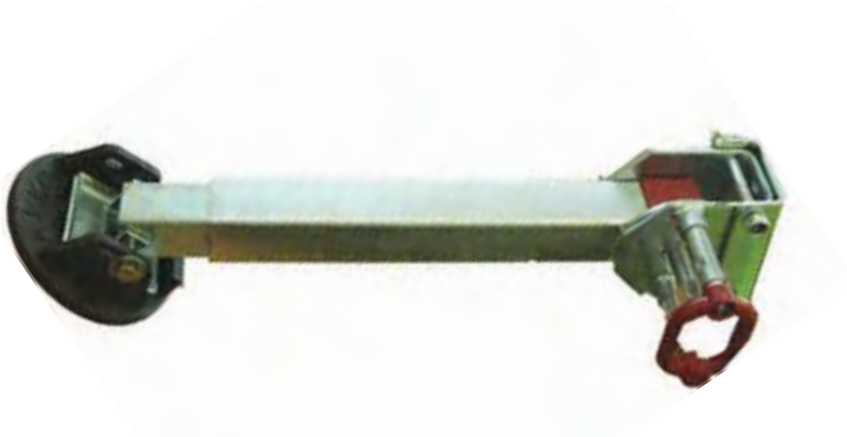

DROP DOWN CORNER STEADIES

AL-KO Hex Drive Drop Down Style Steady Zinc Plated. These stabilisers can also provide vertical support, and are therefore more rigid than the traditional angled legs. Price is for one, corner stabiliser and mounting bracket, the HEX winder handle NOT included.

These corner stabiliser drop down to any angle and are then locked in place with the quick release red handle. The winder (not included, but a socket will also do the job) is then used for the last section. The legs rotate through the full 180 degrees so they can be mounted on the left or right sides.

Each stabiliser comes with a mounting bracket that is usually welded to the chassis and the stabiliser are then bolted to this with the included bolts. They can operate on the angle at any height, just like the traditional wind down legs. Vertical height could be further extended with removable blocks.

- 006483** ADJUSTABLE LEG DROP DOWN CORNER STEADY AL-KO WITH BIG FOOT PAD SET, 590MM LENGTH EXTENDED
- 006485** ADJUSTABLE LEG DROP DOWN CORNER STEADY AL-KO WITH BIG FOOT PAD SET, 740MM LENGTH EXTENDED
- 042662** ADJUSTABLE LEG DROP DOWN CORNER STEADY AL-KO WITH BIG FOOT PAD SET, 820MM LENGTH EXTENDED
- 006488** ADJUSTABLE LEG DROP DOWN MANUTEC 415MM LENGTH
- 006489** ADJUSTABLE LEG DROP DOWN MANUTEC 455MM LENGTH
- 006490** ADJUSTABLE LEG DROP DOWN MANUTEC 515MM LENGTH
- 034280** ADJUSTABLE LEG MANUTEC WELD ON WITH LARGE ALUM FOOT 400MM LENGTH 240MM LIFT
- 042816** ADJUSTABLE LEG MANUTEC WELD ON WITH LARGE ALUM FOOT 620MM LENGTH 240MM LIFT

ADJUSTABLE LEGS AND DROP DOWN CORNER STEADIES SPARE PARTS

CODE	PRODUCT NAME
006484	DROP DOWN CORNER STEADY RED HANDLE AL-KO, REPLACEMENT HANDLE ONLY
042054	ADJUSTABLE LEG DROP DOWN PULL PIN ASSY AL-KO TO SUIT AL-KO LEG
006486	DROP DOWN CORNER STEADY PADS AL-KO BIG FOOT SET OF 4 PROVIDES AN IDEAL FLAT LOAD BEARING SURFACE FOR SOFT GROUND
006499	CRANK HEX HANDLE 800MM AL-KO
006500	1150MM HANDLE (HEX) AL-KO HEX DRIVE
006498	JACK HANDLE DYMWOOD MILLARD OLD STYLE JACK HANDLE
006487	ADJUSTABLE LEG HANDLE SUITS MANUTEC QUICK RELEASE SWING DOWN LEG
006493	ADJUSTABLE LEG HANDLE ARTWELL SLOTTED HANDLE, 565MM OVERALL SIZE
006494	ADJUSTABLE LEG HANDLE ARTWELL SLOTTED HANDLE, 720MM OVERALL SIZE
040233	DROP DOWN CORNER STEADY PLASTIC FOOT MANUTEC PLASTIC FOOT ONLY
040234	DROP DOWN CORNER STEADY ALUMINIUM FOOT MANUTEC ALUMINIUM FOOT ONLY



ARK DROP DOWN STEADY

051359

Latest design with locking swivel bracket and large grip handle for comfortable and easy swivelling. Also features a large flat load bearing foot ideal for soft ground. Large foot locks away and silencer pads reduce noise caused by vibration. Hex drive and zinc finish.

SPECIFICATIONS

- 750mm open length
- Zinc finish

COUPLINGS



COUPLING FIXED PRESSED METAL AL-KO AK7
006276

Zinc plated, 760kg max load.



COUPLING ELECTRICAL AL-KO ZINC PLATED
006280

Suits electric brakes. Quick release, 4 hole bolt on, 3500kg max load. 50mm Ball

SPECIFICATIONS

- Capacity: 3500kg
- Mounting holes: 4 at 182.5mm x 55mm centres
- Zinc plated



VERRIDE COUPLINGS

**006281 COUPLING HYDRAULIC OVERRIDE AL-KO WITH
HANDBRAKE & 3/4" MASTER CYLINDER MAX
LOAD 2000KG**

AL-KO Hydraulic override coupling with 2000kg capacity. Includes brake master cylinder and brake handle.

SPECIFICATIONS

- 2000kg capacity

**006285 COUPLING MECHANICAL OVERRIDE AL-KO
ZINC PLATED, MAX LOAD 2 TONNE, NO HAND
BRAKE, ARM ATTACHMENT**

AL-KO Mechanical override coupling 2000kg, NO brake lever. Four bolt holes.

FEATURES

- Holes are 55mm centres apart, across the coupling
- Holes are 185mm centre to centre from front to rear
- Handbrake handle is a separate part and is not included

SPECIFICATIONS

- Has a capacity of 2000kg
- Zinc plated



COUPLING

006278 COUPLING QUICK RELEASE AL-KO ZINC PLATED, BOLT ON, 2 HOLE, 2000KG MAX LOAD, HEAD ADJUSTING SCREW

AL-KO two hole bolt on coupling. Suit trailers without brakes. The bolt holes are in line.

036199 COUPLING QUICK RELEASE BOLT ON, 3 HOLE, 2270KG MAX LOAD, HEAD ADJUSTING SCREW

006302 COUPLING 4WD FIXED 3PCE TRIGG, OFF ROAD, FULL 360 DEGREE ROTATION, TOWBAR ADAPTOR, POLYBLOCK WITH BRASS BUSHES AND 10MM PIN



COUPLING SPARE PARTS

- 006293 PIN COMPLETE T/S TREG COUPLING WITH SPRING AND LYNCH PIN
- 006294 COUPLING LYNCH PIN CLIP TREG SIZE 6MM
- 006312 REVERSING LATCH TRIGG
- 006315 HANDBRAKE PLATE SUIT TRIGG COUPLING
- 036221 COUPLING REVERSING CATCH AL-KO
- 006322 COUPLING PARTS KIT AL-KO - HANDLE, TRIGGER, SPRINGS, SPINDLE
- 006323 COUPLING TRIGGER AL-KO
- 006327 COUPLING ADJUSTABLE SCREW AND NUT KIT AL-KO
- 006332 COUPLING TRIGGER SPRING AL-KO

- 034823 POLY BLOCK TOWBAR ADAPTOR TRIGG
- 036216 DETACHABLE PIN ASSEMBLY TRIGG
- 041490 COUPLING LOCK RING AL-KO SUIT AKS2000 OFFROAD COUPLING
- 050148 COUPLING OFF ROAD LOCK RING
- 006307 TRIGG SAFETY LOCKING CATCH



036493 VIN PLATE TRAILER I.D. 1 PIECE



036226 VIN PLATE TRAILER I.D. PLATE (2 PIECES)

**039997 COUPLING MOUNT BOLTS SET OF 3
(1 1/2" X 1/2")**

039998 COUPLING MOUNT BOLTS SET OF 4 (4" X 1/2")



DO35 COUPLING V3-R

044634

The V3-R version of the DO35 is without a handbrake and ideal for caravans with a preexisting handbrake mounted elsewhere on the A-frame.

SPECIFICATIONS

- Articulation: 360 degrees axial, minimum 70 degrees other axes
- Locking: Fully ADR 62/02 compliant including automatic secondary lock
- Finish: Supa Alloy 5
- Bolt pattern: 4 bolts at 185mm x 54mm
- Rating: 3.5 Tonne
- Action: Drop-On
- Maintenance: Fully Greasable

DO35 COUPLING SPARE PARTS

- 044640 DO35 TOW PIN WF KIT**
- 044641 DUST CAP C/W LANYARD**
- 044642 DUST CAP C/W LANYARD**
- 044643 WDH HR 550/750 - ADAPTOR**



**DO35 COUPLING V3-I WITH INTEGRATED
HANDBRAKE**

044635

Forged steel, high quality polyurethane, laser cut stainless steel and precision casting has been brought together to increase the couplings strength yet also reduce weight. This updated DO35 is over 50% stronger than the outgoing model. These advanced processes have also allowed the elimination of hitch adaptors allowing you to get on the road with less fuss.

SPECIFICATIONS

- Articulation: 360 degrees axial, minimum 70 degrees other axes.
- Locking: Fully ADR 62/02 compliant including automatic secondary lock
- Finish: Supa Alloy 5
- Bolt pattern: 4 bolts at 185mm x 54mm
- Rating: 3.5 Tonne
- Action: Drop-On
- Maintenance: Fully Greasable



MECH BRAKE ARM ATTACHMENT AL-KO

044568

This AL-KO Lever Hand Brake and Mounting Plate suits the AL-KO Mechanical Override Coupling System.

New design means the handle is less likely to foul rear opening vehicle doors



MECHANICAL PARKING MECHANISM AL-KO

036218

AL-KO top mounting parking lever for mechanical/ Electric trailer/caravan brakes. Has an easy to use press button release. Note: This does not mount directly with 4 hole couplings - but it can be mounted to A-Frame or similar.



**COUPLING HYDRAULIC BRACKET WITH
MASTER CYLINDER**

006317

AL-KO Hydraulic Conversion With 3/4 inch cylinder. Used to convert a AL-KO Mechanical coupling for use with hydraulic brakes.

TREG BLOCK COUPLING AND ACCESSORIES

006301 COUPLING TREG POLYBLOCK WELD ON, MAX LOAD 3000KG, NO HAND BRAKE (WELD ON WITH 3/4 PIN)

Treg is the original off-road polyblock coupling, and if you're fair dinkum about going off road with your trailer this is the coupling for you!

FEATURES

- Coupling body rotates 360 degrees
- Because of it's design the Treg Off Road Coupling allows a huge departure angle with a 70 degrees vertical oscillation angle allowing it to go places where standard couplings would fail.
- No special fitting required just remove your standard tow ball and put the Treg yoke into your standard tow bar tongue and you're away.
- TRIGG handbrake assembly suits this coupling (Not included).

SPECIFICATIONS

- 1 x Treg Poly Block Trailer Coupling
- 1 x Treg Yoke to suit Towing Vehicle
- Bolt on type

006295 COUPLING U BRACKET AND SPRING PIN TREG DETACHABLE

Treg Detachable U Bracket & Pin.

SPECIFICATIONS

- 3000kg
- Pin 3/4 inch
- Thread 3/4 x 2 1/2 inch

006293 TREG COUPLING SPRING/PIN/AND LYNCH PIN KIT

This pin is a direct replacement for the Treg coupling.

SPECIFICATIONS

- 3/4 Inch (19mm) Diameter Pin
- 180mm in Length
- Lynch Pin 1/4 Inch (6mm)
- Zinc Yellow Finish





COUPLING

- 05 1090 ARK OFF ROAD COUPLING ELEC.
- 05 1093 ARK OFF ROAD COUPLING O/R BRAKE
- 05 1094 ARK OFF ROAD COUPLING ELEC. W/RATCHET
- 05 1350 ARK QUICK RELEASE COUPLING
- 05 1352 ARK XO SERIES COUPLING ELEC 3.5T
- 05 1354 ARK OVER RIDE COUPLING ZINC
- 05 1355 ARK OVER RIDE COUPLING GAL.
- 05 1357 ARK ELECTRIC COUPLING ZINC
- 05 1364 ARK OVER RIDE COUPLING
- 05 1367 ARK XO SERIES COUPLING 2T O/R
- 050141 COUPLING PLUNGER TYPE TRIGGER



OFFROAD COUPLING PARK LEVER

050176

Handbrake lever to suit AL-KO offroad coupling 044408.

SPECIFICATIONS

- ALKO Parking Brake arm, mounts under the 4 bolt hole couplings and the ratchet arm catches on the coupling
- Holes are 55mm and 185mm apart
- Low Profile – 140mm from the top of the plate to the bottom of the handle



AL-KO BRAKE COUPLING

044408

Engineered by AL-KO in Australia specifically for extreme off-road adventure, the new AL-KO Off-Road Ball Coupling incorporates extreme vertical and horizontal articulation as well as a quick & easy hitching design that requires no pin or hole alignment.

It's made from high quality materials designed to endure serious off road use and provide you with the confidence you need to take your rig in to even the most remote parts of Australia.

The new & improved range of low profile Off-Road Ball Couplings are suitable for use with a standard 50mm ball.



AL-KO PARKBRAKE

044409

Suits mech o/ride coupling rear holes.

*May require spacer plate for coupling front holes.



PINTLE HOOK

050399

Pintle hook 10 tonne.

SPECIFICATIONS

- Hook Capacity: 6000 kg
- Ball Capacity: N/A
- Mounting Pattern: 45mm x 85mm
- Hole Diameter: 12.5mm
- Surface Finish: Painted



BRAKE SPARE PARTS

- 006361 BRAKE CABLE ADJUSTER WITH PULLEY
- 006362 BRAKE CABLE PULLEY
- 006370 BRAKE CABLE KIT (8M+ADJ+2CLIPS+2PULLEYS)
- 006372 WIRE CABLE CLAMP ONLY 5MM GAL
- 006375 CABLE SWAGE 2.5MM
- 036194 WIRE CABLE CLAMP ONLY 4MM
- 006346 HYDRAULIC MASTER CYLINDER 3/4"
- 006350 HYDRAULIC MASTER CYLINDER CAP ONLY SUIT 3/4"



MASTER CYLINDER CAP 3/4

050110



BRAKE CABLE ADJUSTER SKIN PACK

050146

SPECIFICATIONS

- From slipper springs to tow ball mounts
- All quality materials at a great price
- Easy to install and quality for life



UTILITY LYNCH PIN TRACTOR CLIP B3

035385

SPECIFICATIONS

- 8mm
- 38mm diameter of ring

SPRINGS



LEAF SPRING - EYE TO EYE SHACKLE (CAPACITY LISTED FOR 2 SPRINGS)

036299 45 X 8 X 710 3 LEAF 850KG
036300 45 X 8 X 710 4 LEAF 1100KG
036301 45 X 8 X 710 5 LEAF 1300KG
036302 45 X 8 X 710 6 LEAF 1500KG
040754 45X8X840 7 LEAF 1600KG



SLIPPER SPRING (CAPACITY LISTED FOR 2 SPRINGS)

036328 45 X 6 610 7 LEAF 1350KG
036333 DACROMET 3 LEAF 600KG
036334 DACROMET 4 LEAF 750KG
036335 DACROMET 5 LEAF 1000KG
036336 DACROMET 6 LEAF 1200KG
036337 DACROMET 7 LEAF 1350KG
051563 DACROMET 9 LEAF 1600KG
040757 44 X 6 X 720 6 LEAF 1050KG
040758 44 X 6 X 720 5 LEAF 900KG



TANDEM 45 X 8 X 710 8 LEAF

036309

Offset centre pin to suit rocker tandem axle setups.

SPECIFICATIONS

- 975kg



SPRING KIT AND SPARE PARTS

036364 FRONT U HANGER WITH 12MM HOLE 45MM WIDE

Front U Hanger With 12mm Hole. Suit 45mm springs. These are used the front of either slipper or 2 eye springs. They accept a 12mm or 1/2 Inch bolt x 3 1/2 Inch. Bolt and nut are NOT included.

036365 FRONT U HANGER WITH 14MM HOLE 45MM WIDE

Front U Hanger With 14mm Hole, suit 45mm springs. These are used the front of either slipper or 2 eye springs. They accept a 14mm or 9/16 Inch bolts x 3 1/2 Inch. Bolt and nut are NOT included.

036367 REAR HANGER BLOCK NO BUSH, 22MM I.D.

Rear Hanger Block. These will accept a bush (NOT INCLUDED) 7/8 inch (22mm) outside diameter and 1 3/4 inch (45mm) long. The inside diameter of bush ordered should be 1/2 inch or 9/16 to suit bolts used.

SPECIFICATIONS

- Suit 45mm wide spring
- Requires bush with outside dia. of 7/8 inch

036368 REAR U HANGER SUIT SLIPPER SPRING

Rear Hanger Suit Slipper. These are used only for rear of slipper springs.

NYLON BUSH

044148 NYLON BUSH 1 3/4 X 3/4 X 1/2IN
044149 NYLON BUSH 1 3/4 X 7/8 X 1/2IN
044150 NYLON BUSH 1 3/4 X 7/8 X 9/16IN

036386 NYLON BUSH 60MM X 7/8 X 5/8IN

SPECIFICATIONS

- Length 60mm
- Outside diameter 7/8 inch
- Inside diameter 5/8 inch

006535 NYLON BUSH 1 3/4 X 9/16 X 3/4IN"

SPECIFICATIONS

- Length 1 3/4 inches
- Outside diameter 3/4 inch
- Inside diameter 9/16 inch



036378 SHACKLE PLATE GALVANISED, 1/2" HOLES, 65MM CENTRE TO CENTRE

006526 SHACKLE PLATE 9/16" HOLES, 75MM CENTRE TO CENTRE

038532 SHACKLE PLATE AL-KO BLACK, M16 S/60MM WIDE SPRINGS

036379 SHACKLE PLATE GALVANISED, 9/16" HOLES, 75MM CENTRE TO CENTRE

2 shackles are required for each spring.

038810 SHACKLE BOLT AL-KO GREASEABLE, M16 (S/60MM WIDE SPRINGS NYLOC NOT INCLUDED)

038133 CENTRE ROCKER PIN AL-KO M18 (NYLOC NOT INCLUDED)

036375 SHACKLE BOLT 3 AND 1/2" X 1/2" WHIT

Bolt only 3 1/2 X 1/2 Whitworth. Suit 45mm wide spring assemblies with 12mm holes. Most slipper springs take this bolt in the front eye.

036369 SHACKLE BOLT AND NUT 3 1/2"X9/16" GREASEABLE

Shackle Bolt & Nut, 3 & 1/2 X 9/16, Greaseable, suit 9/16 hole. These come with a Nyloc nut. Suit 45mm springs. Hollow with internal thread to suit grease nipple (nipple not included)

036370 SHACKLE BOLT AND NUT 3 1/2"X5/8" GREASEABLE

Shackle Bolt & Nut, 3 & 1/2 X 5/8, Greaseable. Hollow with internal thread to suit grease nipple (nipple not included). Suit 45mm spring with 5/8 Inch hole in bush.

036371 SHACKLE BOLT AND NUT 3 1/2"X9/16" NON-GREASE

Shackle Bolt & Nut, 3 1/2 X 9/16. These are non-greaseable, suit 9/16 hole and 45mm springs.

006527 FISH PLATE MULTI FIT 8MM BLACK

036380 FISH PLATE GALVANISED, MULTI FIT 8MM

Fish Plate (Multi-Fit) 8mm, Galvanised. Fits 40mm and 45mm axles and 45mm wide springs. Available as Galvanised or Black steel. These are usually placed below the leaf spring, with the u-bolts thread pointing down.

036387 AXLE PAD SUIT FLAT AXLE

Axle Pad Suit Flat Axle. Fits between axle and spring. It is centred over the bolt that holds the spring together.

036376 GREASE NIPPLE STRAIGHT

Grease Nipple Straight. These fit the greaseable shackle bolts

038809 NUT NYLOC M16 AL-KO

038135 NUT NYLOC M18 AL-KO

006530 NUT NYLOC 1/2" WHIT

006531 NUT ZINC PLATE 1/2" WHIT



U BOLTS

The U-Bolts come as either Square ended or Round ended to suit the axle shape.

The length is shown in mm as the first number in the product title.

They come as 40mm, 45mm or 50mm plus some other widths - the width is shown as the second number in the title.

These are all 1/2 whitworth thread, and you must order nuts as separate items. Either 2 nyloc nuts per u-bolt or 4 standard nuts per u-bolt.

Sold each.

036408 ZINC SQUARE 115MM X 40MM 1/2" WHITWORTH SQUARE

036410 ZINC SQUARE 125MM X 45MM 1/2" WHITWORTH SQUARE

036413 ZINC SQUARE 140MM X 45MM 1/2" WHITWORTH SQUARE

036414 ZINC SQUARE 150MM X 40MM 1/2" WHITWORTH SQUARE

036416 ZINC SQUARE 165MM X 45MM 1/2" WHITWORTH SQUARE

036417 ZINC RND 100MM X 40MM 1/2" WHITWORTH ROUND

036418 ZINC RND 125MM X 40MM 1/2" WHITWORTH ROUND

036420 ZINC RND 125MM X 50MM 1/2" WHITWORTH ROUND



SHOCK ABSORBERS

036423 SHOCK ABSORBER KIT - AL-KO

AL-KO, Caravan Shock absorbers, Pair When extended, they are 380mm from centre of top bolt, to centre of lower bolt. They will close down to 250mm, centre to centre.

SPECIFICATIONS

- 2 Shock absorbers
- Left and Right lower mounting bracket (bolt to Spring U-Bolt)
- 2 Upper mounting brackets
- Rated at 1300kg per pair
- Mounting holes in lower bracket are 75mm between centres



FLAT WASHER 1/2IN ZINC PLATED

040006

Suitable for spring and axle U-Bolts.



SPRING ROLLER

043964

Suits rocker/roller tandem spring sets.



UBOLT GAL SQ

050300 75MM X 50MM

050301 60MM X 75MM

050302 100MM X 75MM

050303 100MM X 50MM

050304 125MM X 50MM

050305 125MM X 100MM

Sold in pairs.



GALVANISED U BOLTS WITH NYLOC NUTS

042592 U-BOLT GALVANISED 39MM ROUND

042593 U-BOLT GALVANISED 40MM SQUARE

042594 U-BOLT GALVANISED 45MM SQUARE

Sold each. Includes galvanised nylon nuts.

VEHICLE STEPS



STEP SINGLE TREAD 455X170MM

006501

Single low profile steel step. Used under caravan

SPECIFICATIONS

- Steel 505mm wide
- 180mm deep mounting frame
- Extends 65mm

SPARE PARTS

CODE	PRODUCT NAME
006510	ELECTRIC STEP MAIN SWITCH ONLY
040912	ELECTRIC STEP STANDARD HARNESS LOOM 1300MM LOOM SUIT SINGLE STEP
039820	STEP TENSION SPRINGS PAIR SUITS TECHNO STEPS
036780	ELECTRIC STEP SIDE MOULD GREY PLASTIC SUITS ELECTRIC STEPS
043707	MOTOR ONLY (LEFT SIDE) SUIT 006508 AND 006509

CARAVAN MOVERS



CARAVAN MOVER ELITE® 2 043321

FEATURES

- Economical and effective solution for maneuvering your caravan
- Aluminium rollers that are friendly to tyres
- Optimum compact design, reasonable ground clearance, suitable for almost any light duty single axle chassis
- Corrosion-protected by e-coating and powder coating
- Easy winding action to engage or disengage the roller
- The powerful motor will not allow the RV to roll while being maneuvered on a gradient (Do not use the system as a brake. Always disengage rollers when not in use)
- Caravan/trailer stops immediately and automatically if it is out of range of the remote control or there is malfunction
- Not submersible

SPECIFICATIONS

- Model Elite® 2 Em303
- Part Number 043321
- Operational Voltage 12v Dc
- Average Current Consumption 20 Amps
- Maximum Current Consumption 100 Amps
- Remote Control
- Transmitting Frequency 868 Mhz
- Speed 90mm / Sec.
- Weight 37kg Approx.
- Safe Working Load (Swl) 1,800kg (2 Motors) Or Up To 1,500kg On An 18% Gradient 2,500kg (4 Motors) Or Up To 1,800kg On An 18% Gradient
- Minimum Width (Caravan/Trailer) 1800mm
- Maximum Width (Caravan/Trailer) 2500mm
- Maximum Tyre Width 205mm



CAMEC CARAVAN MOVER ELITE PRO2 043322

FEATURES

- Accurate and durable gearing
- Aluminium rollers that are friendly to tyres
- Simply by pressing the button on remote control handset the rollers will properly engage or disengage on the tyres
- Manoeuvre your caravan effortlessly with soft stop and start
- The powerful motor will not allow the RV to roll while being maneuvered on a gradient (Do not use the system as a brake. Always disengage rollers when not in use)
- Caravan/trailer stops immediately and automatically if it is out of range of the remote control or there is malfunction
- If you forget to disengage the rollers, an emergency function will wind them back if it is connected to a tow vehicle
- Not submersible

SPECIFICATIONS

- Model Elite® Pro 2 Em305
- Part Number 043322
- Operational Voltage 12v Dc
- Average Current Consumption 30 Amps
- Maximum Current Consumption 120 Amps
- Remote Control
- Transmitting Frequency 868 Mhz
- Speed 110mm / Sec
- Weight 33kg Approx.
- Safe Working Load (Swl) 2,000kg (2 Motors) Or Up To 1,750kg On An 18% Gradient 3,000kg (4 Motors) - Up To 2,350kg On An 18% Gradient
- Minimum Width (Caravan/Trailer) 1800mm
- Maximum Width (Caravan/Trailer) 2500mm
- Maximum Tyre Width 205mm



TRAILER VALET MOVER 042965

Manual mover designed for trailers up to 2,200kg with a ball weight of up to 220kg. Perfect for small caravans, campers and car trailers. Very simple to use.

FEATURES

- Attaches to your A-frame and can replace your jockey wheel
- Patented drive system with high and low drive gears (select high or low gear depending on your terrain)
- Brake is incorporated in the system for safety
- Unit can be rotated out of the way on the mount for travel or removed completely
- Spare mounting plates are available to enable you to move the Trailer Valet from one vehicle to another easily

SPECIFICATIONS

- Weight: 20.5kg
- High quality steel with powder-coated hammer finish
- 2 x 9" pneumatic tyres



TRAILER VALET XL MOVER 043705

The Trailer Valet XL is the toughest and most compact trailer dolly. Sharing the same great features as its little brother, but with a few upgrades. The XL moves most trailers up to 4,500kg just using a crank handle or an 18V drill. It features dual, 9" tyres that can handle a ball weight of up to 400kg and positraction technology for making tight turns. The automatic brake engages when the handle is released for superior safety, making it ideal for large caravans, boats, construction and farm equipment, horse floats and flat bed trailers.

FEATURES

- Handles most trailers weighing up to 4,500kg (450kg tongue weight)
- Patented ball attachment mechanism for quick attachment and greater maneuverability
- High strength pneumatic tyres that can withstand 225kg of pressure per tyre
- A greater gear reduction to make cranking even easier
- High quality steel with powdercoat hammer finish
- Brass bearings
- Drill attachment that enables the user to attach most 18V cordless drills
- Automatic safety brake
- One year manufacturer's warranty
- Positraction for maximum traction and ease of handling

SPECIFICATIONS

- Tow ball coupling ball size: 50mm
- Weight: 23.5kg

SPARE PARTS

CODE	PRODUCT NAME
044870	DISTANCE PLATES FOR ELITE PRO 2
043677	CONTROL BOX SERIES 2 ELECTRONICS FOR ELITE PRO
042624	REMOTE HANDSET FOR CAMEC ELITE MOVER
042633	REMOTE HANDSET FOR CAMEC ELITE PRO MOVER
043498	MAINFRAME COVER ELITE
042628	ISOLATION KEY FOR CAMEC ELITE AND ELITE PRO
042632	MOTOR RUBBER COVER IN PAIR
043672	COVER A DECORATION FOR ELITE
043673	COVER B DECORATION FOR ELITE

SPARE PARTS

CODE	PRODUCT NAME
042966	TRAILER VALET MOUNT CLAMP
042967	TRAILER VALET TYRE AND TUBE 2X9"
042968	TRAILER VALET CRANK HANDLE
042969	TRAILER VALET BRAKE CAP HANDLE
043706	TRAILER VALET DRILL ATTACHMENT
050998	TRAILER VALET 1 7/8" BALL



TOWING

Tow Balls, Covers Locks 130

Towing Mirrors 133

Towing Aids, Weight Distribution Hitch ... 135

Brake Controllers & System 139

TOW BALLS, COVERS AND LOCKS



ARK TRAILER LOCK

051365 WITH LOCKABLE HITCH PIN

SPECIFICATIONS

- Separate trailer and hitch pin locks
- Heavy duty trailer lock has double locking system

Secures trailer when attached to vehicle and when unattached

- Hitch Pin Lock prevents tow bar hitch from theft
- One key fits both locks
- Chrome plated finish (Hitch Pin Lock: Towing rating 3500kg)
- Not to be used when towing



COUPLING LOCK TRAILER COP

000385

Fits quick release couplings that take a 50mm ball. Expands into coupling.

FEATURES

- Easy to operate
- Non-corrosive



COUPLING LOCK AND PADLOCK

000395

Secures trailer when attached or not attached to a vehicle.

FEATURES

- Heavy duty 2 position locking system
- Includes padlock
- With built in cover plate to protect padlock access from bolt cutters



COUPLEMATE STAINLESS STEEL HITCH LOCK 85MM

000934

For use as a trailer lock to replace existing pin.

FEATURES

- Suits all receiver types

SPECIFICATIONS

- 85mm
- Longer shaft for use in difficult installations
- Hardened chrome shaft
- Includes key barrel dust cover



COUPLEMATE HITCH PIN LOCK 65MM

000933

For use as a trailer lock to replace existing pin.

FEATURES

- Suits all receiver types

SPECIFICATIONS

- 65mm
- Hardened chrome shaft
- Includes key barrel dust cover



ARK LOCKABLE PULL PIN

000913

Pull pin is straight for easier access in some towbars. Enables you to lock your towball mount onto the towbar preventing theft.

FEATURES

- Includes spring clip for extra protection
- Towing capacity: 3500kg

SPECIFICATIONS

- Chrome



SPRING PIN WITH LOCK TREG KIT

006299

Contains coupling pin and lock for treg polyblock.



D035 BI-LOCK PIN ASSY

044636



ALKO WINCH PREMIUM WPM700W 5:1 1:1 WEBBED

050186

The 1:1 ratio enables the initial retrieval of the boat onto the rollers and the second ratio allow for the full weight of your boat to be pulled onto the trailer, with ease.

FEATURES

- May line pull capacity 700kg
- Webbing length 50mm x 6m
- 6.8kg
- Snap hook



AL-KO UNIVERSAL COUPLING LOCK

050152



ALKO WINCH HANDLE PREMIUM 190MM

050145

This 190mm winch handle suits AL-KO premium marine and trailer winches. The clever handle design allows quick release and re-attachment to the desired gear shaft.



WITi 050965 ANTI-THEFT SYSTEM

WITi offers a revolutionary anti-theft system and is the only anti-theft system designed specifically for caravans and trailers fitted with electric brakes. The WITi Anti-Theft device detects movement via a highly sensitive gyroscope. If a caravan / trailer is hitched or moved slightly whilst the Anti-Theft is active then WITi immediately locks the brakes, flashes all the lights and sounds an alarm. The caravan or camper trailer is completely immobilised and will be impossible to tow.

FEATURES

- Sensitive to movement and sharp knocks / bumps.
- WITi Anti-Theft contains a highly sensitive gyroscope (the same technology found in drones) and is sensitive to acceleration and sharp knocks and bumps.
- Simple to operate and permanently installed in the caravan – no heavy locks, wheel clamps or chains to carry around
- When activated sounds an alarm, flashes all the lights (side markers, tail lights and indicators) and LOCKS the brakes initially for 5 seconds
- Remains active whilst there is movement
- Automatically resets after 30 seconds if no movement is detected
- Built-in safety features

SPECIFICATIONS

- Operating voltage 9V-12V
- Standby current draw \leq 100mA
- Maximum trailer axles – 3 axles
- Maximum rated current – 30 amp
- Weight – 300g
- Operating temperature range – [-20C to 60C]



TOWBALL - MACHINED 006255

1 7/8" chrome plated towball.

SPECIFICATIONS

- Towing Capacity: 2270kg
- Shaft length 51mm
- Shank Size: 7/8" (diam x 51mm(l))
- Chrome
- Not for use in 50mm ball coupling



KOVIX ALARMED U LOCK 051235 KVH-96

Constructed from stainless steel and fitted with an anti-tamper alarm this heavy duty trailer lock will suit most styles of trailers. The Smart Lock alarm system is triggered by movement and activates a 120dB siren which sounds for 10 seconds before resetting. Designed to be used on a variety of trailer types it will suit 50-70mm ball hitches as well as ALKO Offroad 2/3.5T couplings.

FEATURES

- Lock can be used with or without alarm turned on
- 120dB built in anti-tamper alarm with automatic reset
- Weatherproof electronics with long life lithium battery
- On most ball couplings, the KVH can also be locked on while the trailer is attached to your vehicle.

SPECIFICATIONS

- Suits 50mm ball coupling
- Suits 70mm ball coupling
- Suits ALKO Offroad 3.5T
- Suits ALKO Offroad 2T
- 120dB alarm
- Water Resistant Electronics
- Internal Dimensions (mm): 96(w) x 150(h) (Extended)
- Not to be used when towing



TOWBALL - MACHINED LONG THREAD 006250

Standard ball size, extra long shank for fitting stabiliser blocks and bike racks, etc.

SPECIFICATIONS

- Towing Capacity: 2500kg
- Ball size: 50mm
- Shank Size 7/8" (diam) x 80mm(l)
- Chrome



KOVIX TRAILER LOCK ALARMED 050283 KTR-18

Constructed from stainless steel and fitted with an anti-tamper alarm this heavy duty trailer lock will suit most styles of trailers. The Smart Lock alarm system is triggered by movement and activates a 120dB siren which sounds for 10 seconds before resetting. Designed to be used on a variety of trailer types it will suit 50mm ball hitches, Off Road DO35 and Treg-style block hitches.

FEATURES

- Lock can be used with or without alarm turned on 18mm stainless steel locking pin with anti-cutting sleeve
- Anti-impact & drill resistant
- 120dB built in anti-tamper alarm with automatic reset
- Weatherproof electronics with long life lithium battery

SPECIFICATIONS

- Suits 50mm ball coupling
- Suits HITCHMASTER DO35 Hitch (including V3)
- Suits Treg-style block hitch
- 120dB alarm
- 18mm locking pin
- Weatherproof rating IP67
- Overall Dimensions (mm): 175(w) x 100(h) x 37(d)
- Internal Dimensions (mm): 80(w) x 60(h)
- Not to be used when towing



ALKO 50MM TOWBALL 036775

Designed for use with Alko stabiliser coupling.

AKS200 only.



KLAMP IT WHEEL LOCKS

**000402 B KLAMP IT 13"-15" TYRE WIDTH
165MM-185MM**

**000403 C KLAMP IT 13"-17" TYRE WIDTH
195MM-205MM**

**000404 D KLAMP IT 15"-17" TYRE WIDTH
215MM-245MM**



WHEEL LOCK STRETCHMASTER

000406

SPECIFICATIONS

- Multi-fit wheel lock to suit many trailer wheels up to 29cm wide
- 160mm maximum wheel depth



AL-KO EASY CLAMP WHEEL CLAMP

050153

SPECIFICATIONS

- Anti-theft wheel clamp adjustable to suit 13-15" wheels
- Key operated lock with weather cover
- Anti-scratch coating on contact ends
- May not suit some hi-walled tyres



WINCH HANDLE SUIT JARRETT(HEX)

006720



TOWBALL 3T - MACHINED

036443

SPECIFICATIONS

- 50mm x 25mm Diameter Shaft
- Towing capacity: 3,500kg



TOWBALL - MACHINED

006252

Standard towball size.

SPECIFICATIONS

- 50mm x 62mm x 7/8"
- 62mm shank
- Towing Capacity: 3500kg
- Chrome plated



TOWBALL HIGH RISE - MACHINED

006254

High rise towball size with 25mm rise.

SPECIFICATIONS

- 50mm x 51mm x 7/8"
- 51mm shank
- Towing Capacity: 2000kg
- Chrome plated



TOWBALL REDUCING BUSH

050236

SPECIFICATIONS

- 33mm to 22.5mm



BLACK PVC TOWBALL SOFT COVER

000849

Push on towball covers provide protection from grease.

SPECIFICATIONS

- Suits 50mm and 1 7/8" towballs
- Sold individually
- Black



PLASTIC TOWBALL COVER BLACK HARD

000848

Push on towball covers provide protection from grease. With spring clip.

SPECIFICATIONS

- Suits 50mm and 1 7/8" towballs
- Sold individually
- Black



CHROMED PLASTIC TOWBALL COVER

000850

Push on towball covers provide protection from grease. Suits 50mm and 1 and 7/8" towballs.

SPECIFICATIONS

- Chrome Plastic



SHIN PROTECTOR ARK TP11

039991

Made from soft rubber, fits securely over towbar goose neck.

SPECIFICATIONS

- Black



HAYMAN REESE TOWBALLS

CODE	DESCRIPTION
042925	Towball only 50mm capacity 3500kg Interlock
042926	Flat sided towball only 50mm capacity 3500kg



TOWBALL SPANNER

006256

Used for towball nuts, snap-up bracket bolts, D shackles, towbar tongue bolts and adjustable ball mount bolts and nuts.



DO NOT OVERTAKE TURNING VEHICLE STICKER

042870

If your tow rig is near 7m long, a sign like this should be displayed on the back of your vehicle.

SPECIFICATIONS

- Dimensions: 300mm(l) x 125mm(h)
- Regulations vary by state
- Reflective yellow



TOWBALL AND HITCH LUBE

050170

FEATURES

- White grease
- Odourless
- Will not break down
- Reduces friction
- Superior lubricant

TOWING MIRRORS



CAMEC CLIP ON TOWING MIRROR (FLAT GLASS)

040657

Quick and easy to fit and suitable for most vehicles.

FEATURES

- Universal fitting
- Quick and easy to fit
- Aerodynamic and durable
- Supplied with straps for added security
- Sold individually



CAMEC SUCTION CUP TOWING MIRROR

040656

Quick and easy to fit and suitable for most vehicles.

FEATURES

- Universal fitting
- Adjusts with vehicle's power mirror
- Sold individually
- Strong suction cup holds the mirror in place
- No clamping required



CAMEC HEAVY-DUTY MIRROR BRACKET AND STRAP WIDE

034827

Camec Heavy Duty Mirror bracket and strap to suit wide door on some Pajeros, Prados, Klugers, Landcruisers.



CAMEC HEAVY-DUTY MIRROR HEAD ONLY

000995

Replacement heavy duty mirror head to suit Camec Heavy Duty Mirror (refer code 034194).



CAMEC HEAVY DUTY DOOR MIRRORS

034194

Fits most vehicles. This heavy-duty door mounted mirror fits firmly and offers excellent vision. The large mirror head is 229mm(w) x 155mm(h) and is attached to an adjustable extension arm.

FEATURES

- Extends from 330mm to 470mm
- Bottom door bracket is 20mm at widest point
- Sold as a pair - 2/pk

SPECIFICATIONS

- Ratchet T Bar ensures firm fitting
- Quality rubber mounting pads
- Suitable for towing caravans, campers, horse floats, boats, etc



CAMEC HEAVY-DUTY MIRROR STANDARD STRAP/HOOK

036575

Replacement heavy duty mirror strap and hook to suit Camec Heavy Duty Mirror (refer code 034194).



CAMEC HEAVY-DUTY MIRROR RATCHET/SPRING

036576

Replacement ratchet and spring to suit Camec Heavy Duty Mirror (refer code 034194).



ORA TOWING MIRROR - CLIP ON

000962

Suits 2WD and 4WD vehicles.

FEATURES

- This mirror can be extended and swivelled horizontally and vertically
- Easily installed and removed
- Clear visibility when towing vans up to 2.4m wide
- Easily adjusted from inside car
- Pack of 2



COPPA ROSSA/ORA TOWING MIRROR SPARE PARTS

PART NO.	DESCRIPTION
001007	ORA TOWING MIRROR-MAG SUPPORT
001011	ORA TOW/MIRROR EXTENSION STRAP
001016	ORA T/MIRROR TRIANGULAR MOUNT
002452	ORA SPARE GLASS
016917	ORA PLAIN NUT S-BRACKET
038127	ORA NARROW HOOK
038125	ORA HOOK STRAP

CAMEC HEAVY-DUTY MIRROR ADJ SCREW/NUT SET

036577

Replacement adjustable screw and nut to suit Camec Heavy Duty Mirror (refer code 034194).

HAYMAN REESE



70th ANNIVERSARY

1951-2021



WE KNOW TOWING

Since its inception in 1951, Hayman Reese has been the leader in towing and are true pioneers in the industry. Hayman Reese designs, manufactures, tests, and distributes a wide range of towbars, weight distribution hitches, brake controllers and associated accessories.

With over 70 years experience, we know towing.

PHONE: 1800 812 017

HAYMANREESE.COM.AU

TOWING AIDS, WEIGHT DIST HITCH



HAYMAN REESE LED HITCH STEP

050169

FEATURES

- Weight rated to 150kg
- High powered, ultra-bright LED light
- Plug-in ready, coming pre-wired with a 7-pin flat plug
- Multi-function switch configured to illuminate with vehicle reverse and parking lights (where vehicle has been pre-wired for reverse)
- Ideal for additional light when reversing or attaching a trailer in the dark
- Includes tow-ball adaptor to suit, standard flat sided & interlock tow-balls
- Suits most towbar tongues and towball mounts



CAMEC BALL WEIGHT SCALE

051439

A must have to ensure safe and balanced towing by confirming ball weight. 400kg.



042783 D-SHACKLE AND BRIM GAL 8MM RATED 750KG
042784 D-SHACKLE AND BRIM GAL 10MM RATED 1000KG

042785 D-SHACKLE AND BRIM GAL 11MM RATED 150KG

042786 D-SHACKLE AND BRIM GAL 13MM RATED 2000KG



D SHACKLE BLISTER PACKED

050164 8MM

050165 10MM

050166 11MM

FEATURES

- Genuine Hayman Reese rated D-shackles
- Blister Packed

050164* - Recommended for vehicles with a towing capacity of 2,000kg.

050165* - Recommended for vehicles with a towing capacity of 3,500kg.

050166* - Recommended for vehicles with a towing capacity of 6,000kg.

*Where trailer capacity exceeds 2.5 tonnes, two safety chains must be used.

Each with their own D-Shackle



HAYMAN REESE HITCH STEP

050168

This handy Hitch Step from Hayman Reese allows you to easily reach the roof and into the rear of your vehicle. It is quick and simple to install onto almost all Australian tow bars including round, flat-sided and interlock tow balls.

The high grade aluminium construction means it is lightweight, corrosion resistant and looks great. It also features a non-slip tread making it safe to use even when wet. It is designed to remain in place when towing but may need to be removed for tight turns. Please note: This step cannot be used with weight distribution hitches.

FEATURES

- Easy to install
- High grade aluminium construction
- Non-slip tread
- Fits most tow bars

SPECIFICATIONS

- Weight Rating: 120kg
- Dimensions (mm): 350 x 80 x 50



HAMMERLOCK SHACKLE

051481

Suits 10mm chain 3.15 rating.



HAMMERLOCK SHACKLE

051480

Suits 13mm chain 5.35 rating.



HAYMAN REESE STANDARD MEDIUM DUTY WEIGHT DISTRIBUTION

CODE	SERIES	SPRING BAR	MAX TOWING WEIGHT
040572	CLASSIC 600LB	30"	135-275KG
040468	CLASSIC 800LB	30"	275-365KG

Distributes the ball weight across both axles of the tow vehicle to restore the correct steering and suspension geometry, braking efficiency and headlight alignment.

FEATURES

- Round/under slung 30" spring bar
- Head includes integrated friction sway tab
- Compatible with dual cam sway control (not included)
- Drop shank allows for 6 incremental height adjustments
- Hex cam adjustment washer allows for up to 6 head angle adjustments
- Suitable for A-frames up to 6"



HAYMAN REESE CLASSIC MEDIUM DUTY WEIGHT DISTRIBUTION

CODE	CLASSIC SERIES	SPRING BAR	MAX TOWING WEIGHT
040081	600LB	30"	135 - 275KG
040084	800LB	28"	275 - 365KG
040083	800LB	30"	275 - 365KG

Suitable for ball weights between 135kg and 275kg, the Hayman Reese 600lb classic Weight Distribution kit comes with trunnion style spring bars that are ideal for trailers and caravans that have a 4" A-frame, with the coupling mounted on the top, or with a 5" and 6" A-frame, with the coupling mounted on the bottom.

FEATURES

- Trunnion style 30" spring bar
- Head includes integrated friction sway tab
- Compatible with dual cam sway control (not included)
- Drop shank allows for 6 incremental height adjustments
- Hex cam adjustment washer allows for up to 6 head angle adjustments



PRO SERIES WEIGHT DISTRIBUTION

CODE	SERIES	SPRING BAR	MAX TOWING WEIGHT
041822	PRO SERIES 600LB	30" ROUND	135-275KG
041823	PRO SERIES 800LB	30" ROUND	275 - 365KG

Distributes the ball weight across both axles of the tow vehicle to restore the correct steering and suspension geometry, braking efficiency and headlight alignment.

FEATURES

- Round/under slung 30" spring bar
- Head includes integrated friction sway tab
- Drop shank allows for 6 incremental height adjustments
- Hex cam adjustment washer allows for up to 6 head angle adjustments
- Suitable for A-frames up to 6"



REESE 1200LB SUPER H/D WDH

040085

FEATURES

- Head includes integrated friction sway tab
- Compatible with dual cam sway control (not included)
- Drop shank allows for 6 incremental height adjustments
- Manufactured for serious heavy duty towing, it has a fine tooth adjustment washer which allows for up to nine head angle adjustments



HAYMAN REESE SNAP-UP BRACKET ONLY (21120)

035311

For use with Hayman Reese hitch.

- Please note: These do not come with a bolt. The bolt is 1/2" x 2 1/2" UNC and are not grade specific.

FEATURES

- To suit weight distribution hitch
- Bolt (not included) screws into clamp bracket to A-frame of caravan
- Not supplied with snap up pin



PROSERIES FRICTON SWAY CONTROL (PRO4000)

043016

Friction Sway Control uses friction to resist pivotal movement and thereby works against the effects of induced sway. It operates on the principle of "stiffening" the coupling between the tow vehicle and trailer. The degree of "stiffening" or friction is adjusted to suit various trailer weights and towing conditions. Its operation is simple and uncomplicated. It doesn't prevent the generation of sway; it simply works to resist the forces once they have started.

FEATURES

- Installs and removes easily
- Removes with two spring locking pins
- Heavy construction for added reliability
- Friction brake keeps trailer and tow vehicle stable
- Quick attachment to trailer frame and ball mount
- Can only be used on one side



HAYMAN REESE 3/8IN U-BOLT KIT-CHAIN

000908

Joins spring bar to spring bar chains.

SPECIFICATIONS

- 3/8"
- Includes washer and nut



REESE A.B.M. BOLT KIT

000925

Replacement bolt kit to suit Hayman Reese adjustable ball mount head on weight distribution hitch.

FEATURES

- Includes bolts, nuts and washers



REESE FRICTION SWAY TOWBALL ADAPTOR

043273

Attaches to existing 75mm wide Hayman Reese trailer ballmount to allow fitting of friction sway control (043016)



TRAILER-BLISTER PULL PIN-CLIP

050160

Pull pin and cup in one handy blister pack.



PINTLE HOOK ADAPTOR

000889

To suit heavy duty 50x50mm hitch receiver towbars. Maximum load: 3500kg.

SPECIFICATIONS

- Size: 240mm tube length 83mm from full pin hole to end of tube



PINTLE HOOK ADAPTOR 210MM LONG

035295

Pintle Hooks are the alternative to the standard 50mm towball. Pintle Hooks are particularly used in commercial applications.

SPECIFICATIONS

- Pintle hook adaptor to suit heavy duty 50mm x 50mm hitch receiver towbars
- Trailer ball mount with 195mm lug to suit pintle hook
- Size: 210mm O/A length, 83mm from pull pin hole to end of tube
- Maximum Load Weight: 3500kg



HAYMAN REESE SCREW SET SNAP-UP BKT

000910

SPECIFICATIONS

- 1/2" x 2"
- Sold singly



HAYMAN REESE TOWBALL MOUNT 12"

035292

SPECIFICATIONS

- 2250kg capacity
- Commonly used for utes with overhanging trays



HAYMAN REESE SNAP UP BRACKET HANDLE

000912

For use with 035311 snap up bracket.



SNAP UP SAFETY PIN

050154

Stops snap on bracket from disengaging.

SPECIFICATIONS

- 2 per packet



HAYMAN REESE HITCH PULL PIN

000915 PULL UP PIN

000916 CLIP SUIT PULL PIN

Standard hitch pin.



SILENT HITCH PIN

050159

FEATURES

- Intelligent Solution For Deterring Thieves
- Includes 2 Keys
- Helps silence rattling
- Hollow ballmounts



R CLIPS

000811 3MM FOR RV TOWAID

000812 4MM



HAYMAN REESE INTERLOCK TOWBALL

042924

5 hole adjustable. maximum towing capacity 2250kg includes towball



HAYMAN REESE ADJUSTABLE TOWBALL MOUNT (70207)

042921

Includes towball.

SPECIFICATIONS

- Maximum Towing Capacity: 3500kg
- Suitable for use with DO35 when not using weight distribution
- Supplied with standard drop shank 040469



ADJUSTABLE BALL MOUNT HEAD ONLY

042948

Adjustable 3500kg Tbm Head - Hayman Reese.

Use with choice of drop shanks 040469 / 040470 / 040471 / 040472



HAYMAN REESE DROP SHANK

040469 STANDARD

040470 30MM

040471 95MM

040472 160MM

Hayman Reese have a range of drop shanks available. Suitable for 4WDs and other vehicles where the lowest/highest setting is not low or high enough. Using the standard shank.



HAYMAN REESE SECURE TOWING KIT 2500KG

050171

The Secure Towing Kit comprises of a Trailer Ball Mount (TBM), Flat-Sided Towball and Locking Hitch Pin. This Kit provides the perfect replacement for worn or lost TBM's with the added bonus of a locking Hitch Pin for added security.

FEATURES

- There are two Secure Towing Kits in the range - one rated to 2,500kg and the other rated to 3,500kg.
- Each one has been tested and certified to exceed Australian design standards.

SPECIFICATIONS

- Trailer Ball Mount: Fits 50mm Hitch Receivers, Rated up to 2500kg, Superior Finish Towball: Genuine Hayman Reese 50mm, 3500kg rated flat sided tow ball, Nut and spring washer
- Hitch Pin: Anti-theft Lockable Hitch Pin with spare key
- Overall length 316mm
- The dimension from the end of the receiver to the centre of the lock pin is 83mm
- The dimension from the centre of the lock pin hole to centre of the ball mount hole is 192mm

HAYMAN REESE SECURE TOWING KIT 3500KG

050172



The Secure Towing Kit comprises of a Trailer Ball Mount (TBM), Flat-Sided Towball and Locking Hitch Pin. This Kit provides the perfect replacement for worn or lost TBM's with the added bonus of a locking Hitch Pin for added security.

FEATURES

- There are two Secure Towing Kits in the range - one rated to 2,500kg and the other rated to 3,500kg.
- Each one has been tested and certified to exceed Australian design standards.

SPECIFICATIONS

- Trailer Ball Mount: Fits 50mm Hitch Receivers, rated up to 3500kg, Superior Finish
- Towball: Genuine Hayman Reese 50mm, 3500kg rated flat sided tow ball, Nut and spring washer
- Hitch Pin: Anti-theft Lockable Hitch Pin with spare key
- The dimension from the centre of the lock pin hole to centre of the ball mount hole is 209mm

HAYMAN REESE SPRING LOADED HITCH COVER

050163



FEATURES

- Fits most 50mm x 50mm hitch receivers
- Durable plastic
- Quick and easy installation mounting hex key included

REESE HITCH BOX COVER - RUBBER

035959



FEATURES

- Hayman Reese Hitchbox Cover, Black rubber. Fits into Reese hitch after towball mount is removed.



EQUALIZER A FRAME BRACKET KIT

000820

FEATURES

- Replacement equaliser brackets and B-plates (with bolts) Pack of 2.
- Suits standard 100mm 4" A-frame
- Used on the older 'Shepherds Hook' style of hitch



EQUALIZER 6" A FRAME BRACKET KIT

000822

Galvanised equalizer bracket set for use if your A-frame is more than 100mm deep. Suits 6" (150mm) A-frames.

SPECIFICATIONS

- Length: 150mm
- Weight: 2.33kg
- Pack of 2



BACKSAVER CLASSIC RV TOWAID

000407

Adjustable mechanical aid to assist placing equalizer rods into chassis brackets - saves back muscles.



COUPLEMATE BALL ATTACHMENT AID

001024 BALL ATTACHMENT AID
001026 SPARE BASE PLATE

The Couplemate is an innovative self-aligning accessory designed to locate the trailer coupling directly over the ball without assistance, physical effort or guiding. It can also be used as a theft deterrent by securing the trailer to the vehicle.

FEATURES

- Suits standard towball and torsion bar fittings
- Long shank towballs are recommended when used in conjunction with torsion bar fittings
- Wings can be locked in the security position as a theft deterrent whilst towing or when the vehicle and/or trailer are left unattended



TRAILER-HITCH BOX COVER

050162

Aesthetic aluminium surround for the Hayman Reese hitch receiver box

BRAKE CONTROLLERS & SYSTEM



BRAKE CONTROLLER VOYAGER (9030)

000947

This easy to install electronic brake controller features advanced electronics that minimises false braking to give a smoother ride, even on the roughest roads.

FEATURES

- Compact and easy to install
- Minimises false braking
- Suits 2-4 magnets
- Includes mounting kit



BRAKE CONTROLLER TEKONSHA P3 (90195)

038367

One of the more advanced approaches to trailer brake controls. Requires no manual leveling. Self adjusting sensing device to allow for easy, flexible installation from nearly horizontal to nearly vertical. Will constantly adjust itself to the position of tow vehicle.

FEATURES

- Allows the user to switch between electric over hydraulic or electric trailer brake mode
- Highly advanced - easy to understand roadside diagnostics
- Easy access - controls upfront
- Compact dash hugging design
- Easy to use - clip mounting system

SPECIFICATIONS:

- Dimensions: 115mm(l) x 27mm(h) x 80mm(d)
- Weight: 650gms
- Made for up to 4 axle trailer brake systems



BRAKE CONTROLLER SENTINEL (05650)

040752

Simple operation, slim design and a wide range of mounting options make it the perfect choice for today's towing vehicles. No moving parts or pendulums to adjust, it can be mounted in virtually any position.

FEATURES

- Digital display, solid state, no moving parts
- Compact size, mounts anywhere
- Advanced internal circuit protection to prevent damage if incorrectly wired
- No hydraulic connections
- No levelling required

SPECIFICATIONS

- Includes mounting bracket, hardware and instructions
- For use on 12V negative ground systems only
- Smartclick compatibility offers plug and play functionality allowing a quick and easy connect to any Smartclick brake control body harness



HAYMAN REESE BRAKE COMPACT CONTROLLER

042927

The Hayman Reese Compact joins the already reliable range of Hayman Reese Brake Controls and, like the name suggests, is compact enough to be installed when space is a big factor. The controls are mounted in the dash, with the main control unit mounted out of sight. Very few tools are needed to carry out the installation with a drill, crimp tool, wire cutter and circuit tester all you need to complete your job.

FEATURES

- Compact size
- Electric trailer brake control for 1-3 axles
- Plug and play feature allows for quick and easy connection with the Hayman Reese Smartclick brake control harness
- Unique sync adjustment for towing different trailers
- Flexible and neat mounting options
- Green LED indicator monitors a secure connection with your trailer
- Remote mount ensures no issues with hitting the brake control unit or damaging it whilst moving in your vehicle
- Remote mount is less likely to interfere with any airbag deployment zones e.g. knee or lower leg

SPECIFICATIONS

- 3 year limited warranty
- Quick connect plug
- Power output control/manual override button
- Sync control
- LED indicator



BREAKAWAY SYSTEM CAMEC

040119

041767 - REPLACEMENT BATTERY

Install on your caravan or trailer A-frame or in any protected position. It includes a battery that can apply your caravan or trailer electric brakes for at least 15mins in the event the caravan or trailers is disconnected from the tow vehicle. This is a mandatory addition to any caravan or trailer that exceeds 2.0 tonnes.

FEATURES

- Charging of the battery can be done via the tow vehicle auxiliary line
- Rechargeable battery included, manual test circuit and battery charge indicator
- Single and dual axle, compact and easy to install
- Includes breakaway switch
- Test circuit included and battery charge level indicator



TRICKLE CHARGER SLA 12V 1A

044433

A mains powered Lead Acid battery charger designed for 12V batteries. Features intelligent automatic charge controller to stop charging when the battery is full and maintain the battery with a 'floating' charge mode. This feature allows you to leave the charger connected to the battery without risk of overcharging and know your battery is always ready to go. Includes a 2m long cable with interchangeable DC plug and Alligator clips.

SPECIFICATIONS

- Charging voltage: 12V
- Charging current: 1 amp
- Dimensions: 70mm(l) x 40mm(d) x 40mm(w)
- Recommended for charging breakaway system batteries



ARK ELECTRIC BREAK AWAY SYSTEM

051349

FEATURES

- Suitable for 2 and 4 wheel brake systems
- Built-in battery charger, charges battery while plugged into vehicle
- LED test lights indicate state of a battery charge
- 5Ah battery - Includes Break-away switch.



ELECTRIC BREAK AWAY SWITCH

050112

Genuine Alko replacement part



BREAKAWAY KIT TEKONSHA 2028

000939 BREAKAWAY KIT COMPLETE
000938 REPLACEMENT SWITCH

Lockable breakaway kit for all single, tandem and tri-axle breakaway applications.

FEATURES

- Kit contains a polymer battery case with A-frame or post mounting bracket and a 12V sealed rechargeable 5A battery.



BREAKAWAY KIT HOPKINS

042758

The Engager Breakaway Kit features simple wiring for easy installation. Does not include any remote monitoring function.

FEATURES

- Easy to read LED meter
- Activates trailer brakes upon separation from the tow vehicle.
- 1-2 axle capacity



BREAKAWAY KIT 6000 BREAKSAFE

000940 6000 KIT - SUIT UP TO 4 WHEEL TRAILER

Designed to automatically apply the electric brakes and brake lights on the trailer in the event of an accidental separation from the tow vehicle.

FEATURES

- Automatically recharges when connected to tow vehicle
- Compact and easy to install

SPECIFICATIONS

Please note: A unit of this type must be installed on trailers in excess of 2000kg if built after July 1989.

- Monitor Dimensions: 64mm(w) x 25mm(h) x 50mm(d)
- Monitor Weight: 80g (039363)



BREAKSAFE REMOTE MONITOR RM6000

039363

BREAKAWAY KIT 6000XP BREAKSAFE

000942 SUIT 6 WHEEL TRAILERS

The Breaksafe 6000XP has the addition of many innovative new features including easy access to the battery compartment for servicing and fully enclosed internal circuit board case for better water resistance.

The Breaksafe 6000 Breakaway System activates the electric brake system and brake lights of your Caravan or Trailer if it is accidentally separated from the tow vehicle (e.g. Breakaway).

The battery compartment is easily accessible and features a fully enclosed circuit board case for better water resistance.

The kit includes a 7ah battery, coil cable breakaway switch, mounting hardware and installation instructions.

The breaksafe battery recharges while driving through an auxiliary line or you can use an external battery charger. You can also test the condition of the battery with a simple push of the button on the front of the unit.

SPECIFICATIONS

- Applies electric brakes on up to 6 wheels, if a trailer/caravan gets separated from tow vehicle
- Keeps brakes applied for up to 20 minutes
- Includes a 7ah battery that re-charges while you drive
- Suitable for: Caravans, trailers, horse floats and campers



BRAKE CONTROLLERS & SYSTEM

**BREKSAFE BATTERY 4024****000941**

Replacement batteries for the Breaksafe unit.

SPECIFICATIONS

- 12V
- 7aH
- 93mm(h) x 65mm(w) x 152mm(l)
- Weight: 2kg

**BREKSAFE REPLACEMENT COIL & PIN****042482**

Breakaway Coil Cable and stainless steel quick release clip for easy connection to the tow vehicle. This also makes the connection to the tow vehicle much tidier. No more wrapping the wire up to stop it dragging on the ground. The new Coil Cable stretches to 1.2 metres for connection to the tow vehicle and then compresses back to only 100mm long when disconnected.

The new coil cable comes with the cable, stainless steel quick release clip and pin to suit Breaksafe breakaway switch.

**BREKSAFE BREAKAWAY SWITCH****042483**

The Breaksafe breakaway switch now comes with the new Coil Cable and stainless steel quick release clip for easy connection to the tow vehicle. This also makes the connection to the tow vehicle much tidier. No more wrapping the wire up to stop it dragging on the ground. The new Coil Cable stretches to 1.2 metres for connection to the tow vehicle and then compresses back to only 100mm long when disconnected.

FEATURES

- New Coil Cable
- Stainless steel quick release clip.
- Stainless steel mounting bracket.

**WITI OPTIONAL GPS TRACKING AND MOBILE PHONE ALERTS****051535****FEATURES**

- Requires WiTi anti-theft system 050965
- Ongoing fees apply
- Free downloadable app provides information the location of the RV as well as key information such as battery voltage and alarm status

**WITI WIRELESS TOWING INTERFACE****051536****FEATURES**

- Requires WiTi anti-theft system
- No more cables - transmits lighting and braking signals wirelessly
- NB - If ESC fitted, brand must be specified when ordering. this will determine the version of software used to ensure compatibility

**WITI WIRELESS ELECT BRAKE CONTROL WITH HILL ASSIST****051537****FEATURES**

- Requires WiTi anti-theft system
- Simply plug the wireless brake controller into a standard 12V cigarette lighter socket in your vehicle. The WiTi brake controller will automatically pair with your WiTi anti-theft system when in range
- NB - If ESC fitted, brand must be specified when ordering. this will determine the version of software used to ensure compatibility. Eg. Alko / Dexter etc



HARDWARE & FURNITURE

Mattresses.....	142
Table Legs.....	143
Hinges.....	147
Cupboard Catches.....	148
Handles.....	150
Cupboard Stays.....	150
Gas Struts.....	151
Storage.....	151
One Key System.....	152
Internal Fixings.....	153
External Fixings.....	154
Curtains.....	156
Room Dividers.....	157
Roof.....	158

MATTRESSES



MATTRESS INNERSPRING

- 042832 CUT CORNER 1830 X 1370 X 210
- 042833 STANDARD 1880 X 1220 X 210
- 042834 CUT CORNER 1880 X 1220 X 210
- 042835 SINGLE 1830 X 760 X 210
- 042836 CUT CORNER WITH BOLSTER 1830 (+100) X 1370 X 210
- 042837 CUT CORNER WITH BOLSTER 1830 (+100) X 1500 X 210

There is nothing like a good night's sleep, especially after a hard day's travel. The latest range of Camec mattresses are designed with comfort and support in mind. Made from high quality, durable non-woven Damask fabric, they feature Bonnell hard coil springs, a 2cm high density foam top layer, 400g white cotton felt and come in a range of sizes that will suit nearly all caravans and pop tops. Features a 5 year warranty.

Bolster Explanation: During the day the extra 100mm bolster can be placed on top of the mattress at the head end to provide more space in the RV. At night it can be dropped down to increase the mattress length.

TABLE LEGS



TABLE HINGE SECTION

034298 4M CLEAR ANODISED MALE

034299 4M CLEAR ANODISED FEMALE

035210 MALE & FEMALE SECTION - 495MM LONG

Male section mounts onto table and the female section attaches to the wall.



ALI TABLE HINGE 995MM

007958 MALE

007959 FEMALE

FEATURES

- This clip system releases by lifting the far end of the table up - the sections then are easy to separate
- The table requires some form of leg or support at the end away from the clip section.



PLASTIC HINGE - TABLE SUPPORT LEG

007908

Replacement plastic hinge for table support legs (refer codes 007873, 007874 and 007875). Suitable for folding the table leg.



BREHA TABLE SUPPORT LEG

007873 305MM

007874 355MM

007875 457MM

Hinged support leg for table tops when converting to bed base.



TABLE SLIDE RAIL KIT

007960

Suits bi-fold and folding table legs.

Kit includes: 2 x plugs, 2 x brackets

1 x 500mm Rail

1 x 950mm Rail

FEATURES

- Attaches to a table top to a wall
- 2 x supplied brackets clip to the aluminium rail to secure table
- 2 x length rails included to allow table to be attached in two separate locations
- Table requires some form of leg support at other end



PLASTIC BRACKET - TABLE SLIDE

007961

Replacement bracket for table slide kit (refer code 007960).



TABLE LEG - WINEGLASS BENT TUBE

035213

5pcs-Grey Base Silver Zinc Leg.

FEATURES

- Centre bent tube section removes to fold table down, and allows the table to rotate in an offset method to give greater clearance
- The top is removable with a finger knob and does not include a table top

SPECIFICATIONS

- Table Leg Height: 700mm
- Base: 430mm (diameter)
- Top Plate: 300mm x 170mm
- Pipe: 38mm outside diameter
- Pipe Offset: 200mm
- Grey



WINEGLASS TABLE LEG WITH ANGLE IRON TOP

007884

A wineglass shaped leg with an angle iron split top.

SPECIFICATIONS

- Table Leg Height: 730mm
- Base: 420mm(diam)
- 38mm tube



WINEGLASS TABLE LEG

044956

This Wineglass Table Leg complete with base and top comes in four parts (top plate, tube, bottom plate & anchor), making it easier to pack up and store while on the go in your caravan or camping.

SPECIFICATIONS

- Silver leg black top
- Wineglass table leg complete with base & top
- Includes: 1x top plate, 1 x leg tube, 1 x bottom plate, 1 x anchor
- Height: 700mm including base
- Finish: Powder Coated
- Weight: 5kg
- 45mm tube



WINEGLASS TABLE LEG - PLATE TOP

007885

Wineglass Table leg in grey. Four pieces make up this table. It has a removable base which can be bolted or unbolted from floor with a finger bolt inside base.

FEATURES

- Centre tube section removes to fold table down.
- The top is removable with a finger knob.
- This does NOT include a table top, these must be individually made by the customer.
- 38mm tube



BREHA ISLAND TUBE TABLE LEG SET

007876

SPECIFICATIONS

- Bottom plate is recessed into the floor to stop any tripping hazard when the table is removed
- 45mm tube



BREHA CLIP - ISLAND LEG POLE

007912

For storage of island table leg poles when table is not in use. Suits 45mm tube.



BREHA CHROME TUBE FOR PEDESTAL TABLE LEG

007924

SPECIFICATIONS

- Dimensions: 690mm(h) x 44.5mm(d)



TOP PLATE SWING AWAY TABLE LEG

007895

Suits 38mm diameter tube.



TOP PLATE - TUBULAR ISLAND LEG

007909

Replacement top plate for Island tube table set (refer code 007876). Suits 45mm diameter tube.



EASY-LIFT TABLE LEG AND ADJUSTABLE PLATE

007890

This telescopic table leg has an adjustable height floor plate to allow for correct height setting when table is being used as a bed base. Lock knob tightens a friction shim to prevent accidental movement.

SPECIFICATIONS

- Overall Height: 855mm
- Closed Height: 480mm



TOP PLATE FOR PEDESTAL TABLE LEG SPLIT

007921

Replacement top plate for pedestal table leg split. Suits 45mm tube.



TABLE LEG COLLAR SWING AWAY

007897

Replacement swing away collar for table leg (refer code 007892).



SWING AWAY TABLE LEG 4 PIECE

007892

Swings away where space is very restricted. Designed to swing table out of the way when not being used to provide more space in van.

FEATURES

- Includes leg, top plate and bottom plug to secure to floor
- Collar attaches to the side of seat to give added support to leg
- 2 legs required for longer tables

SPECIFICATIONS

- Underside of Table to Floor: 750mm
- Offset: 210mm
- Tube Dimension: 38mm
- Weight: 2.79kg



FOLDING TABLE LEG - 675MM

007906

This unique table top hinge leg offers versatility and portability. The table top can be lifted from the wall bracket and conveniently positioned elsewhere on the caravan, even outdoors.

SPECIFICATIONS

- Hinged at the top to allow folding
- Ideal for stowing table top when space is a premium
- Can be used with table hinge section (P3) or table kit (007960 - P3)



TABLE LEG - V TYPE 710 MM

007904

These simple "V" shaped, chromed wire legs which lock for vertical support, can pivot horizontally under the table top for ease of storage or when the table top is being used as a bed.

SPECIFICATIONS

- Dimensions: 80mm(w) x 710mm(h) x 20mm(d)



BI-FOLD TABLE LEG - 675MM

007905

This unique table top hinge leg offers versatility and portability. It can also serve as a bed base.

FEATURES

- Unique European style aluminium leg
- Adjusts to both table and bed height
- Table top can be lifted from the wall bracket and positioned elsewhere on the caravan, even outside

SPECIFICATIONS

- Height: 675mm
- Bi-Fold Height: 315mm



PRIMERO COMFORT TABLE SUPPORT

044429

The elegant Primero Comfort Table Support offers the complete range of functionality and usability for modern caravan and motor homes. Designed and tested to offer maximal stability, longevity and flexibility while considering space and weight. This table support can be moved down smoothly by pulling the handle to convert into an additional sleeping area. While the gas spring helps to raise the table back into its dining position considering space and weight.

FEATURES

- Light Weight
- Reduced height compared to previous model (8mm)
- New ergonomic designed handle
- Small footplate to save space
- No screw cover plate required
- Swivel function

SPECIFICATIONS

- Height: 300-600mm
- Swing: 360mm
- Weight: 7.7kg

FIAMMA TUBE PRO TABLE LEG

007913 RECESS BASE PLATE

007914 DOME TOP PLATE

040199 FOLDING TRIPOD BASE

040271 TUBE PRO TABLE LEG

Chrome tube for the Tube Pro 70 table leg. Made from anodised aluminium.

SPECIFICATIONS

- The Tube Pro table leg comprises of 3 parts - tube (code 040271), flush top (code 007914), recessed base (code 007913) and optional tripod used to convert table for outdoor use (code 040199). Each item is sold individually
- Can easily be dismantled and stored
- Height: 700mm - height adjustable



PEDESTAL TABLE LEG - ANGLE IRON TOP

007880

The 4 way chrome base is bolted to the floor with the supplied eye bolt. The table can be easily removed to use outside or as a bed base. The chrome tube and angle iron top can be removed by undoing the wing nuts top and bottom. Two long & 2 short legs on base.

FEATURES

- Can be anchored to the floor for travel but can also be moved for use elsewhere
- Freestanding
- Sturdy table legs with an angle iron top plate for extra support
- Includes 2 long and 2 short legs on base

SPECIFICATIONS

- Table Leg Height: 690mm
- Long Base: 615mm x 830mm



KNOB - SWING AWAY TABLE LEG

007899

For wall mounted use. Bottom plug secures to the floor for the tube to swivel, the collar is attached to the side of the seat or wall to give added support to the leg.

LOCKING KNOB - EASY LIFT LEG

007940

Replacement locking knob with a 3/8" Whitworth thread to suit Eazy lift table leg (refer code 007890).

SPECIFICATIONS

- 3/8" Whitworth thread Black

WING NUT HANDLE

007923

Wing nut handle for pedestal table leg.

HINGES



FOLDING BRACKET 305MM WHITE

008006

305mm spring loaded. Can be used for folding bench tops or foot stool supports.

SPECIFICATIONS

- White
- Locks into place when raised
- Easy release



BUTT HINGE NYLON 51MM

008019

FEATURES

- Nylon
- Heavy duty
- Durable

SPECIFICATIONS

- 51mm



BUTTERFLY HINGE

008034 NICKEL

008036 BRASS



CUPBOARD HINGE FLAT

008033

A semi concealed offset leaf cupboard hinge. Fits flush on the outside of the frame and flush on the inside of the door.

SPECIFICATIONS

- Zinc finish
- Hole centres on long side: 52mm
- Hole centres on short side: 26mm



CUPBOARD HINGE

008027 FLAT BRASS

Popular semi concealed flat leaf cupboard hinge in a choice of two finishes.



MINI DOOR OFFSET HINGE NO 18

015651

Semi concealed lightweight, non-rusting, aluminium hinge for mini access doors.

SPECIFICATIONS

- Chrome

CUPBOARD CATCHES



ROLLER CATCH-CUPBOARD

008059

Blister Pack of 2.
A positive action roller catch.



SCREW GRIPPER CATCH

008060



CUPBOARD VERTICAL CATCH NYLON

008061

Gripper catch, vertical. Used to keep cupboard doors or draws closed. This version is usually placed on a vertical side.

FEATURES

- Strong and positive nylon gripper catch for cupboard doors and drawers
- Vertical striker
- Base Width: 13mm x 32mm
- 2 Pieces



CUPBOARD HORIZONTAL CATCH NYLON

008062

Gripper catch, horizontal. Two pieces that make up the horizontal gripper catch. Used to keep cupboard doors or draws closed.

FEATURES

- Strong and positive nylon gripper catch for cupboard doors and drawers
- Horizontal striker
- Base Width: 13mm x 32mm
- 2 Pieces



FEMALE SECTION-C/CATCH WHITE

008063

Nylon.



CUPBOARD CATCH

008078

A strong plastic spring-loaded catch used in many early Franklin caravans (2 part).

SPECIFICATIONS

- Ideal for doors that are 10mm thick
- Measures 73mm from rear single screw hole to each front screw hole
- Brown



CUPBOARD CATCH

008081

A strong plastic spring-loaded catch used in many early model caravans (2 part).

- Brown



CAMEC NICKEL CATCH SET

008089 13MM

008091 19MM

Camec nickel catch set includes catch, rosette, knob and striker plate. Knob sits near flush with drawer when locked and pops out when pressed to open.



CUPBOARD CATCH LONG STEM

008080

The 1269B long stem cupboard catch is a pull catch that suits a cupboard door with a 20mm thickness. It accepts various knobs and includes striker plate.



MINI CUPBOARD CATCH STRIKER

008095



COMPRESSION LATCH

051723



COROMAL BOOT LOCK

051648

CAMEC CUPBOARD CATCHES

ROSETTES



PART NO.	DESCRIPTION
008141	MINI NICKEL PLATED
008150	16MM NICKEL PLATED S/16MM THICK DOOR
008156	19MM NICKEL PLATED S/19MM THICK DOOR
008157	19MM WHITE S/19MM THICK DOOR

BACK CATCH



PART NO.	DESCRIPTION
008097	LARGE WHITE
008143	MINI BROWN
008144	MINI NICKEL PLATED
008145	MINI WHITE

PUSH BUTTON KNOB



PART NO.	DESCRIPTION
008133	16-19MM NICKEL PLATED
008134	16-19MM WHITE
008137	MINI NICKEL PLATED

ANGLE STRIKERS - OPTIONAL



PART NO.	DESCRIPTION
008103	PUSH BUTTON CATCH STRIKER CATCH



LOCKWOOD 200 STREAMLATCH

008235

Main door lock ideal for narrow door stiles.

- Chrome



COMPRESS LATCH FLUSH FITTING

008238 SMALL

017166 LARGE

For use on Service Doors.

- Chrome

HANDLES



EMRO HANDLE - 150MM

036752

A strong chrome plated handle suitable as a pull handle on the corner of caravan.

SPECIFICATIONS

- Length: 130mm
- Chrome
- 4 hole mounting



CHROME GRAB HANDLE

007977 100MM

007979 152MM



VECAM GRAB HANDLE

007980 GREY

007983 WHITE

A strong plastic grab handle suitable as a pull handle on the corner of caravans or camper trailers. Gasket not included. Please use silicone under the handle and also on the threads of your screws.

SPECIFICATIONS

- Overall Length: 160mm
- 23mm between hole centres horizontally
- 136mm between hole centres vertically



VECAM GRAB HANDLE GASKET

007981 GREY

007984 WHITE

Replacement gasket for grab handle (refer code 007980 and 007983).



GRAB HANDLE PLASTIC

007988

A strong plastic grab handle suitable as a pull handle on the corner of caravans or camper trailers.

SPECIFICATIONS

- White
- Overall Length: 175mm
- 16mm between hole centres horizontally
- 153mm between hole centres vertically

CUPBOARD STAYS



FIRMOTOP STAY CUPBOARD STAY UP

008009

FEATURES

- Chrome finish cupboard stay up
- Spring pressure supports the flap when raised and holds it firmly against the cabinet when closed

SPECIFICATIONS

- Opens to 130mm overall
- Chrome



802 WINDOW STAY

008014 SMALL

This folding stay is available in two sizes and was often used as a window stay in older caravans.

SPECIFICATIONS

- Small measures 75mm from central pivot to outer pivot
- Large measures 100mm from central pivot to outer pivot

GAS STRUTS



GAS STRUTS

These are used to assist the lifting of the roof of many pop-tops. Please note: Ensure the extended length is suitable and that the ends are similar. Confirm Newton rating on your existing gas strut.

040273 125N - 195.5MM - 12.25KG CAPACITY

015645 150N - 317MM - 15KG CAPACITY

035305 150N - 450MM - 15KG CAPACITY

008406 100N - 525MM - 10KG CAPACITY

008407 150N - 525MM - 15KG CAPACITY

008408 200N - 525MM - 20KG CAPACITY

008424 230N - 525MM - 23KG CAPACITY

008397 240N - 825MM - 24KG CAPACITY

035302 250N - 430MM - 25KG CAPACITY

008409 250N - 525MM - 25KG CAPACITY

008398 290N - 825MM - 29KG CAPACITY

008410 300N - 525MM - 30KG CAPACITY

008425 330N - 525MM - 33KG CAPACITY

008395 330N - 825MM - 33KG CAPACITY

008411 350N - 525MM - 35KG CAPACITY

008412 400N - 525MM - 40KG CAPACITY

008396 435N - 525MM - 43.5KG CAPACITY

008413 500N - 525MM - 50KG CAPACITY

035297 600N - 525MM - 60KG CAPACITY

NB: M8 nuts are not supplied with gas struts

STORAGE



ROLLOUT PANTRY AND BASKETS

000122 2 X 110MM BASKETS AND FRAME

000125 2 X 200MM BASKETS AND FRAME

The pantry comes with 2 chrome plated wire baskets that clip onto the frame. Can be made to different widths to suit the door opening. The main frame is tube steel which slides into the cupboard on reversible runners. Additional baskets are also available.

FEATURES

- Keeps goods secure while travelling
- Includes chrome plated baskets

SPECIFICATIONS

- Frame Dimension: 470mm(d) x 570mm(h)
- Min space required 480(d) x 600 (h)



ROLLOUT PANTRY BASKET

000124 110MM

Replacement or spare pantry basket to suit rollout pantry (refer code 000122 Rollout Pantry). This is a chrome plated wire basket that clips onto the rollout pantry frame.

SPECIFICATIONS

- Dimensions: 460mm(l) x 110mm(w) x 110mm(h)



ROLLOUT PANTRY BASKET

000127 200MM

Replacement or spare pantry basket to suit rollout pantry (refer code 000125 - Rollout Pantry and 200mm Baskets). This is a chrome plated wire basket that clips onto the roll out pantry frame.

SPECIFICATIONS

- Dimension: 460mm(l) x 200mm(w) x 110mm(h)

ONE KEY SYSTEM

One key fits all system. Used to replace a multitude of different keys, with one. Fits Camec locks only, or Thetford access doors (requires adaptor 043073 or 040185). Additional barrels with specific key numbers can be special ordered.



ONE KEY BARREL KIT

- 042087 - BARREL 2*
- 042088 - BARREL 4*
- 042089 - BARREL 6*
- 042090 - BARREL 8*
- 043071 - BARREL 12*
- 041815 - BARREL 20*

*NB: One barrel in each kit is a longer one to fit the deeper boot lock 042092, 044947, 044946



ONE KEY DOOR LOCK

042093

Replacement outer housing for all Camec 3-point locking doors. This housing will enable it to accommodate the One Key Fits All barrel. Replacement housing only required for doors without a Camec logo on the handle.



ONE KEY FITS ALL T HANDLE WINDSOR RAPID DOOR NO BARREL

- 042092 REPLACEMENT HANDLE - CHROME
- 042508 BARREL ONLY, GENERIC KEY
- 042509 BARREL ONLY, KEYED TO MATCH ALL OTHER KEYS (SPECIAL ORDER)
- 044947 BLACK
- 044946 SATIN

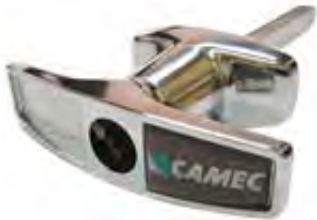

ONE KEY LARGE T HANDLE

- 044947 BLACK
- 044946 SATIN

Fits all rapid glider boot doors



PADLOCK KIT

041567 PADLOCK WITH 2 BARRELS

This chrome plated padlock is fitted with Camec's One Key Fits All barrel. Each padlock can be keyed alike to the same key as the other locks on the caravan/RV. See your Camec RV retailer if you require additional keyed alike barrels for your application. Padlock shackle diameter is 6.3mm.



ONE KEY FITS ALL T HANDLE SMALL BOOT DOOR NO BARREL

- 042091 REPLACEMENT HANDLE
- 042506 BARREL ONLY GENERIC KEY
- 042507 BARREL ONLY KEYED TO MATCH ALL OTHER KEYS (SPECIAL ORDER)

The replacement handle features a housing capable of accommodating the One Key Fits All barrel.



ONE KEY FITS ALL CAMEC 2RC MINI

040268

Supplied with additional shorter cam for a van water filler application.



ONE KEY ZADI ADAPTOR

- 043073 BLACK
- 040185 ALL BARREL ADAPTOR - WHITE

One key fits all adaptor to suit the Thetford access/ toilet door

FEATURES

- Two adaptors per packet
- Some installation required.



ONE KEY FITS ALL CAMEC TONGUE LOCK HOUSINGS

- 040186 CAMEC SQ ACCESS
 - 040187 ALL STORAGE
- Suits one key fits all system



ONE KEY RED ASSEMBLY KEY

- 041577 SUITS LOCKS BEFORE 2015
- 051826 SUITS LOCKS AFTER 2015

INTERNAL FIXINGS

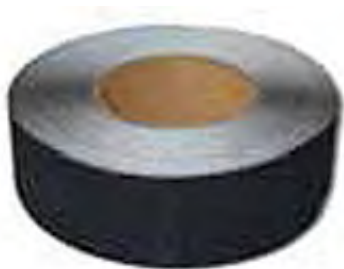

NON SKID GRIP TAPE

000167

FEATURES

- Anti slip grit surface improves footing on step ladders and trailer frames
- Dimensions: 50mm(w) x 18m(l) roll



TOWEL RAIL PILLAR END AND CENTRES

008196 PILLAR CENTRE 3/4" 19MM RAIL CHROME

008197 PILLAR END 3/4" - 19MM RAIL CHROME

008201 PILLAR END 5/8" - 16MM RAIL CHROME

008200 PILLAR CENTRE 5/8" - 16MM RAIL CHROME



3/4" RAIL OVAL SHAPE

008198

To suit 19mm towel rails. Chrome plated steel.

SPECIFICATIONS

- 3/4" - 19MM Rail



5/8" FLANGE OVAL SHAPE

008202

SPECIFICATIONS

- To suit 16MM Rail



CHROMED BRASS THROUGH PILLAR

008219 PILLAR THROUGH

008223 PILLAR END NICKEL

008222 PILLAR CORNER

Chromed Brass Pillar 4mm. These are used as shelf surrounds, with 4mm rod. The corner pillar has 2 holes at 90 degrees to each other, the end pillar hole goes only half way thru and the through pillar has a hole going all the way through.

FEATURES

- NO threaded bolts are included with these.



TOWEL RAIL 3.6M

008203 CHROME PLATED 19MM X 3.6M

039112 STAINLESS STEEL 16MM X 3.6M

039113 STAINLESS STEEL 19MM X 3.6M

Commonly used as a drying rail at front or rear of RV.



TRAY RAIL NICKLE PLATED

008215

SPECIFICATIONS

- 1.8m
- 4mm diameter



CAMLOCK - LONG TONGUE

008231

SPECIFICATIONS

- 22mm Bolt Lock tongue
- Keyed alike

EXTERNAL FIXINGS



TAILGATE LATCH-SPRING LOADED

035326

A common fixture to hold tailgates up on trays.



KNOBLOCK W-METAL PLATE WHITE

035438

Pushout window Knob Lock With Metal Plate, White knob. Suit older style, pushout windows. These pop-rivet onto window. Plastic is held to metal with a rivet.



MILLARD POW PLASTIC/METAL LOCK

008553

Push out window swivel lock with plastic lever with metal base. Colour: Black.



VISCOUNT POW GREY KNOB LOCK

008556

Nylon push out window lock.

SPECIFICATIONS

- Grey



CAMLOCK - SHORT THREAD LONG TONGUE

008239

SPECIFICATIONS

- Keyed alike



CAMLOCK-SHORT THREAD SHORT TONGUE

008240 SHORT THREAD KEYED ALIKE

035550 SHORT THREAD RANDOM KEY



CAMLOCK - LONG THREAD

008243 LONG THREAD RANDOM KEY

008242 LONG THREAD KEY/ALIKE

Access door lock or Coin Machine Lock, long thread. Fits a 19mm hole with an overlap of 2mm.



FIAMMA SECURITY DOOR HANDLE

000746 HAND 31CM

000747 HAND 46CM

Fiamma Helping Hand Door Handle is made of solid aluminium. It serves as a convenient handle to make entering and exiting the vehicle easier. When closed back onto the door, it works as an anti-theft device.



FIAMMA SECURITY 46 PRO HANDLE

034093

Security handles take up little space when folded against wall. They serve as a useful handle to make entering and exiting the vehicle easier. They adapt to all doors, opening both to the right and left. Includes installation brackets, screws and internal counter brackets.



SWINGING BOLT - 2 PIECE

007997

Used on old style protector shades

SPECIFICATIONS

- 38mm and plate

**SWINGING BOLT 50MM & PLATE****007998**

Anti rattle Catch, stainless steel, with plate, 50mm bolt. These are often used to hold shut a protector shade or old style hatch. They are stainless steel with an alloy nut.

**CORNER ANGLE****008158****SPECIFICATIONS**

- White

**HOLDING CATCH ACCESS DOOR****008161****SPECIFICATIONS**

- White
- Holds the access door lid open to leave your hands free

**CABIN HOOK****008182 75MM WITH EYE****008183 100MM WITH EYE****008185 150MM WITH EYE****008186 200MM WITH EYE****008187 EYE - CABIN HOOK****ROUND DOOR STOP & SCREW 75MM****008228****SPECIFICATIONS**

- White

**SCREEN DOOR LOCK****008244**

Used on camper trailer doors and shower doors

SPECIFICATIONS

- Silver
- Also know as a 'Tulip' lock

**GARAGE LOCK CAST TONGUE****008248****SPECIFICATIONS**

- Dimensions: 120mm(l) x 10mm(h) x 10mm(d)
- Commonly used on the back of the square thread of 'T' Handles to allow opening from the rear

**FLY SCREEN TURN BUTTON 5/16****008258**

A simple locking device for hinged fly screens.

SPECIFICATIONS

- Black

**CAMEC OUTER HANDLE****014382**

Suits Camec 3 point lock

CURTAINS



METRO CURTAIN TRACK

036495

FEATURES

- White
- Runners and tape extra

SPECIFICATIONS

- 5M long
- Accepts 035440 runners



METRO CURTAIN RUNNER

035440

To suit aluminium track (refer code 036495).

SPECIFICATIONS

- White
- Use approx 12 x per metre of track
- Flat base



CURTAIN ROD 16MM POWDER CTD WHITE X 5M

007771

FEATURES

- Steel conduit
- Dimensions: 5m(l) x 16mm(diam)
- White



EXPANDING PLASTIC COATED WIRE

007775

FEATURES

- White
- Use 007802 screw eye or 007803 screw hook each end to make hanging curtains easy
- Sold per metre



TRACK ALI MINI GLIDE TOP 5M CA

007779

FEATURES

- Clear anodised
- Suits curtain runners with curved base



SNAP IN MUSLIN BRACKET - WHITE

007786

Use screws or double sided tape to attach to wall or ceiling.

FEATURES

- The removable cap fits onto 16mm curtain rod, then connects into the bracket. Simple design allows for easy removal of curtain clips
- White



SCREW

007802 SCREW EYE

007803 SCREW HOOK

- Suits 007775 Wire



NYLON CURTAIN GATHERING HOOK

007800

FEATURES

- White
- Lightweight gathering hook
- Use with 035440 curtain runner and 036495 metro curtain track and 007810 tape.



END STOP PUSH IN - MINI TRACK

007798

To suit metro track.

FEATURES

- Place one at each end of the curtain to stop them from sliding off the track



STEEL CURTAIN GATHERING HOOK NO 7

007799

FEATURES

- Strong hook to be used to hang curtains made with gathering tape attached
- Use with 035440 curtain runner, 036495 metro curtain track and 007810 tape.



GATHERING TAPE NATURAL

007810

Per Metre

FEATURES

- Sewn to top of curtain for easy attachment of gathering hooks for use in runners/track



JAYCO CURTAIN TAB

007807

These plastic curtain tabs slide into the curtain track commonly found in Jayco caravans. The tabs are sewn into the top of your curtain allowing it to slide easily into the existing track.

FEATURES

- Sold each



JAYCO CURTAIN RUNNER

007808

FEATURES

- Common runner used in Jayco vans that utilise 2 x white nylon runners

ROOM DIVIDER



REMI ROOM DIVIDER

007770

SPECIFICATIONS

- 1500w X 1900h
- High quality pleated material can be used to partition an open space to create a cosy, intimate atmosphere
- Compact design
- Low weight
- Quiet to operate
- Grey material

ROOF

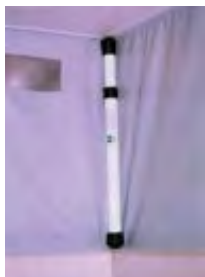

POP TOP INTERIOR SUPPORT

035303

Internal support for pop top camper roof.

Extendable support for pop tops when lift mechanisms or gas struts need a little extra help.



CAMPER ROOF CLAMP SILVER

008265

This clamp is commonly used on pop top caravans and wind up campers to hold down the roof while the trailer is in storage or while travelling.

FEATURES

- Includes clamp and J clip
- Australian made
- Zinc plated



CAMPER ROOF CLAMP LOCKABLE

008267

This clamp is commonly used on pop top caravans and wind up campers to hold down the roof while the trailer is in storage or while travelling.

FEATURES

- Includes toggle clamp, space for lock and extra locking bracket suitable for a small padlock (not included)
- Zinc plated



TONGUE - STANDARD ROOF CLAMP SILVER

008269

Replacement zinc plated tongue for the standard and locking silver clamp.

SPECIFICATIONS

- Silver



J CLIP - ROOF CLAMP SILVER

008270

Replacement J Clip for both standard and locking silver clamps.

SPECIFICATIONS

- Silver



703 TOGGLE CLAMP WITH PLATE

008276

Special locking catch mechanism prohibits the latch opening accidentally.

SPECIFICATIONS

- Plate included
- Dimensions: 160mm(l) x 20mm(h) x 40mm(d)



DROP NOSE PIN

008289

This simple locking device has many applications such as securing the raiser arm roof clamp.

SPECIFICATIONS

- Dimensions:
 - 8mm thick
 - 70mm O/A length
- Suits max 45mm section



CAMPER TRAILER 3-STAGE LIFTER

008302

3-stage lifter.

SPECIFICATIONS

- Outer Tube Dimensions: 710mm(l) x 32mm(w) x 32mm(d)
- Largest section measures (with wings) 750mm x 30x30mm
- Middle section extends 600mm.
- Top section extends 640mm



CAMPER FLEX PUSH ROD

008305

SPECIFICATIONS

- Length: 1677mm
- Flexible rod used for pushing camper trailer lifters up



SLUGS FOR CAMPER TRAILER (4)

008307

Set of 4. these folded metal slugs fit inside the floor tracks.

The cable lays inside the floor track adjacent to the push rod, with a swage attached to end. The swage prevents the cable pulling thru the slug. Tension on the cable, pulls the slug which pushes the push rod through the floor track, round the corner bend and up inside the telescopic arm, thus raising the roof. The cable goes through the largest corner slit.



CAMPER WIND-UP MECH HANDLE

008328

Suits winches with square tube drive.



STAINLESS STEEL CABLE 3/32"

008332

To suit wind up mechanisms. Per metre.



REPLACEMENT SPRING FOR LIFTERS

- 008350 FLAT 700MM LIFTER**
- 008351 FLAT 900MM LIFTER**
- 008352 FLAT 1200MM LIFTER**
- 008359 SPRING - TUBULAR CANOPY LIFTER**



CANOPY LIFTER FLAT

- 008341 700MM**
- 008342 BREHA 900MM**
- 008344 SUNLINER 900MM**
- 008345 1200MM**

Canopy lift mechanisms are used to raise and lower the roof of pop-top caravans and campers. Note: When replacing the lifter it is recommended that the opposite lifter be replaced at the same time to prevent undue stress.

- | | |
|---------------------------------|---------------------------------|
| 008341 - FLAT CROSS BARS | 008344 - FLAT CROSS BARS |
| • 35kg capacity | • 30kg capacity |
| • Max lift height 560mm | • Max lift height 685mm |
| 008342 - FLAT CROSS BARS | 008345 - FLAT CROSS BARS |
| • 40kg capacity | • 35kg capacity |
| • Max lift height 685mm | • Max lift height 990mm |



CANOPY LIFTER TUBULAR 900MM

008353

SPECIFICATIONS

- Spring Tension: Standard
- Maximum Lift: 685mm
- Width: 900mm
- Max Weight: 40kg per piece
- Note: When replacing the lifter it is recommended that the opposite lifter be replaced at the same time to prevent undue stress
- Tubular cross bars



POPTOP TENSIONER

- 034083 168MM ELASTIC ONLY S/008429**
- 034084 210MM ELASTIC ONLY S/008433**
- 008429 320MM PLASTIC ONLY**
- 008433 390MM PLASTIC ONLY**

Elasticised tensioner to keep pop-top sleeve taut whilst elevated and tucked inside the body when lowered.



CANOPY LIFT NYLON ROLLER + PIN

- 008347 FLAT LIFTER ROLLER BLACK**
- 008348 FLAT LIFTER ROLL RIVET**
- 008349 BREHA CANOPY LIFT NYLON ROLLER + PIN**
- 008355 WHITE ROLLER TUBULAR LIFTER WHITE**
- 008356 RIVET FOR TUBULAR LIFTER**
- 035379 TUBULAR CANOPY LIFT NYLON ROLL AND RIVET**



HATCHES & VENTS

- Camec Roof Hatches 160
- Camec Roof Hatches Spare Parts 161
- Fiamma Roof Hatches 162
- Fiamma Roof Hatches Spare Parts 164
- Roof Hatches 165
- Roof Hatches Spare Parts 166
- Vents & Cowls..... 168
- Vents & Cowls Spare Parts..... 170

CAMEC ROOF HATCHES



CAMEC 4 SEASONS HATCH 500 X 700

051335

The Camec 4 Season Evolution Roof Hatch is not only the most versatile and easy to use hatch but now has improved design, LED lights and roller blind. These features take the practical hatch into a modern and stylish caravan feature.

FEATURES

- Fully designed in Australia for Australasian Conditions
- Retains Camec's famous 4 season functionality
- Passive ventilation – 182cm²
- Each flap has three opening positions (Closed, Rain Mode, Fully Open)
- New elegant design
- Tough ASA construction resulting in improved sealant adhesion
- Fully tested in Australia
- Easy installation from inside the RV
- Includes skylight – tinted high impact resistant acrylic
- Includes custom roller blind with multiple detent positions
- Integrated LEDs
- White colour temperature selectable, blue night light function and dimmable
- Ergonomic vent controls
- 2 Year Warranty

SPECIFICATIONS

- Cut out size: 700 x 500



CAMEC 4 SEASONS EVOLUTION ROOF HATCH 660 X 660

044479

The Camec 4 Season Evolution Roof Hatch in the classic 660x660 square size. Capturing the essence of what caravaners love about the 4 season hatch, and improving on its ease of installation and use.

FEATURES

- Fully designed and tested in Australia for Australasian conditions
- Retains Camec's famous 4 season functionality
- Classic 660x660 square cutout means no change, and also makes it retrofittable to upgrade your old 4 seasons hatch
- Exceeds 220cm² passive ventilation as per previous model, to meet all or part of gas regulation requirements
- Ergonomic vent controls
- Each flap has three opening positions (closed, rain mode, fully open)
- New elegant design, matching the 500x700 4 Seasons Evolution Roof Hatch
- Tough ASA construction resulting in improved sealant adhesion
- Easy installation from inside the RV
- Air Deflector integrated into housing. No additional components required.

SPECIFICATIONS

- Cut out size: 660 x 660
- Extended Dimensions: 715mm x 715mm
- Suit roof thickness up to 70mm
- Internal trim supplied as standard

CAMEC 4 SEASONS HATCH INTERNAL TRIM

To suit Camec 4 Seasons Hatch.



CODE	NAME	ROOF THICKNESS	COLOUR
039977	CAMEC 4SH INTERNAL TRIM (FROM 2011 - 2018)	40MM	WHITE
039927	CAMEC 4SH INTERNAL TRIM (FROM 2011 - 2018)	50MM	WHITE
039978	CAMEC 4SH INTERNAL TRIM (FROM 2011 - 2018)	60MM	WHITE
039979	CAMEC 4SH INTERNAL TRIM (FROM 2011 - 2018)	70MM	WHITE

CAMEC ROOF HATCH SPARE PARTS



CAMEC 4 SEASONS HATCH MIDGE INSECT SCREEN

016431

(Old Style - Prior 2011) Replacement midge insect screen for Camec 4 Seasons Hatch.



CAMEC 4 SEASON HATCH INSECT SCREEN

016430

(Old Style - Prior 2011) Replacement insect screen for Camec 4 Seasons Hatch.



CAMEC 4 SEASONS HATCH FLY SCREEN

040158

Replacement fly screen for Camec 4 Seasons Hatch



CAMEC 4 SEASONS HATCH LIFT MECH/FASTENER/CENTRE BAR

016432

(Old Style - Prior 2011) Replacement lift mechanism, fastener and centre bar for Camec 4 Seasons Hatch.

SPECIFICATIONS

- Set of 3 parts



CAMEC 4 SEASONS HATCH PLASTIC FRAME WHITE 75MM - PRE 2011

016438

Replacement plastic frame for Camec 4 Seasons Hatch.

SPECIFICATIONS

- 3mm ABS
- Colour: White
- Roof thickness: 75mm

CAMEC 4 SEASONS HATCH SHADE END (L&R) & CNR POST

019467

This plastic corner post suits the CAMEC Aluminium Four Seasons hatch that was fitted to Caravans from the late 1970's until the hatches were replaced by the all Plastic Four Season hatch in 2010.

CAMEC 4 SEASONS EVOLUTION ROOF HATCH SPARE PARTS

044728 FLYSCREEN

044730 OPENING FLAP

044731 OPENING FLAP - SHORT 500 SIDE

044732 WINDER

044481 LED STRIP

051295 SPRING & SPACER

050218 BOLT COVER TRIM - GREY

043579 SCREWS

FIAMMA ROOF HATCHES



FIAMMA VENT 500MM X 500MM COMBI WITH ROLLER BLIND

008636 CRYSTAL LID HATCH

008637 WHITE LID HATCH

Opens on all four sides with practical handles. Maintains constant ventilation in the vehicle. Supplied with a standard roller blind with two rollers, one blackout and one with fly screen.

FEATURES

- Locking anti-theft device on handle
- ABE approved
- High quality UV ray resistant materials
- Permanent ventilation
- Rainproof and windproof

SPECIFICATIONS

- Dimensions Outside: 570mm x 570mm
- Dimensions Inside: 550mm x 550mm
- Cutout: 500mm x 500mm
- Hatch Closed: 85mm
- Suits roof thickness 30mm to 70mm

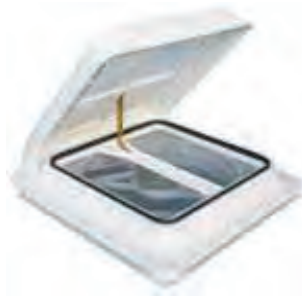

FIAMMA TURBO VENT PRO HATCH

008645

FEATURES

- 12V DC variable speed motor with 10 blades exchanges inside air within seconds
- Finger touch control
- Transparent grating permits maximum air circulation and light filtration
- Polar control thermostat: regulates incoming and outgoing air according to the vehicle's inside temperature
- Water tight

SPECIFICATIONS

- 12V
- Absorbed Power: 36W
- Maximum Air Flow: 35m³/min
- Fan Diameter: 300mm
- Minimum Electric Input: 0.3A
- White



FIAMMA TURBO PREMIUM VENT

044583

High quality and durability thanks to the elegant external aerodynamic profile top, this vent does not require the use of a spoiler. During high-speed testing, noise and vibrations were greatly reduced. The outer cover and exclusive patented rubber seal, guarantee a watertight system and ensures that rain is displaced. ABE approved. Made with high quality UV-ray resistant materials.

Interchangeable with the old 40x40cm Fiamma vents and with vents from 36x36cm to 42x42cm thanks to the reinforced frame. Supplied with permanent air flow ventilation and mosquito screen.

Features a large 10 blade fan with 12V DC variable speed motor. It changes and refreshes the air inside your vehicle within seconds. The electronic circuit ensures a rapid, problem-free, change of rotation. The transparent grating permits maximum air circulation and filters light. The Premium version of Fiamma Turbo-Vent has been given a modern design with advanced finger-touch controls; the state of the art interface is completed by brand new multicolor LED lights. Speed setting and switching now have acceleration ease which helps saving the Turbo-Vent motor and the vehicle control unit.

SPECIFICATIONS

- Power Supply: 12 Vcc
- Power Consumption: 36 W
- Min electric input: 0.2 Amp
- Max electric input: 3 Amp
- Max air flow: 35 m³/min
- Fan diameter: 300 mm
- Permanent air flow: 80 cm²

FIAMMA VENT 280F

050969 CRYSTAL LID

008640 WHITE LID

The Fiamma Vent 28 F is a compact roof vent ideal for small room installation. Available with White or Crystal (transparent) hatch's they are fitted with an aluminium mosquito net and provide permanent ventilation. The new design incorporates the provision for an easy upgrade using the 12v Turbo Fan Kit, while the improved aerodynamic shape eliminates the need for additional spoilers.

FEATURES

- Aerodynamic: Due to the aerodynamic shape no spoiler is needed
- Sandwich assembly: Quick installation without needing to cut more holes in the roof of your vehicle
- Slim frame: Minimum vertical dimensions on the vehicle ceiling
- Bright interiors: The opening mechanism is arranged to guarantee plenty of light inside
- Aluminium mosquito net: Equipped with sturdy, rigid aluminium mosquito net, removable for easy cleaning
- Opening system: Handy opening system with handwheel
- Permanent ventilation: The double layer cover ensures constant exchange of air
- Optional Accessories: The roof light can be motorised using the Kit Turbo-Vent 28 F - 050968

- 1 year warranty.

SPECIFICATIONS

- Hatch Colour: 050969 Crystal or 008640 White
- Cutout Dimensions: 28cm x 28cm
- Weight: 1.8kg
- External Dimensions: 32cm x 34cm x 9cm
- Internal Dimensions: 31cm x 34cm
- Permanent Air Flow: 80cm²
- Inside light: 25 x 25cm
- Suits Roof Thickness: 2.8cm - 6.0cm





FIAMMA KIT TURBO VENT SUIT 28F

050968

Optional kit to upgrade the standard Fiamma Vent 28F to include a 12v circulation fan.

The kit includes a new internal garnish and 12v fan with transparent blades.

FEATURES

- This is the fan kit only

SPECIFICATIONS

- Voltage: 12V
- Absorbed power: 25W
- Max electric input: 1.9amp
- Max air flow: 9 m³/min
- Fan diameter: 180 mm
- Permanent air flow 50 cm²
- Some minor modification to existing hatch lid required



FIAMMA CRYSTAL LID HATCH

008617

Simple and functional ventilation system. Can be left open while travelling and provides ventilation even when closed.

FEATURES

- Easily installed in 360mm x 360mm or 400mm x 400mm opening
- Includes fly screen
- Crystal lid



FIAMMA TOTAL WHITE HATCH

051246

Ideal for motorhomes, caravans and van conversions, allows constant air circulation.

FEATURES

- Internal and external frame now in new neutral white colour
- 40x40 cm cut out
- Standard mosquito net, optional blind
- Made with high quality UV ray resistant materials.
- Easily installed in 360mm x 360mm or 400mm x 400mm opening



FIAMMA WHITE LID HATCH

040694

FEATURES

- Made with high-quality UV-ray resistant materials and TV and ABE approved.
- Roof light opens and closes using the winding handle.
- The maximum stability is provided by the center support adjusting arm.
- Integrated mosquito netting prevents debris from entering the motorhome.
- Can be installed on roofs with depths of between 3cm to 5cm out of the box

SPECIFICATIONS

- Install to roof aperture: 39cm.
- Materials: Shock & UV ray-resistant.
- Colours: Outside frame White, inside frame Ivory.

FIAMMA ROOF HATCH SPARE PARTS



FIAMMA HATCH BLIND KIT 400MM X 400MM ROLLO VENT

008638

Roller blind system, perfect for installing on Fiamma Vent 40 x 40 roof lights. Permanent air flow and ventilation thanks to side grills. Low profile frame. 2 rollers, one is a block-out, the other is a fly screen. Easy installation without drilling: use the same fixing points of Fiamma Vent 40 and Turbo Vent frames.

- Colour: Ivory



FIAMMA HATCH LID 400MM X 400MM - OLD STYLE (14" X 14")

008613

Replacement lid to suit Fiamma 14" x 14" vent.

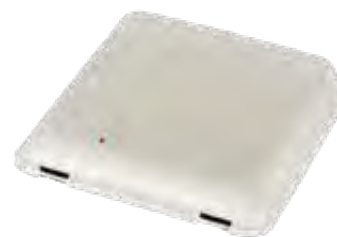

FIAMMA HATCH LID 400MM X 400MM (14" X 14")

008615

Replacement lid for Fiamma standard and turbo 40 x 40 vents. Note: Please be aware of aerodynamics of vent. Will not fit earlier model.

- Colour: White



FIAMMA LID 500MM X 500MM OUTER AND INNER (20" X 20")

008644

Suits Fiamma 50 x 50 roof vent.

FEATURES

- Comes in two sections - outer cover and inner lid cover
- No additional fittings included
- White

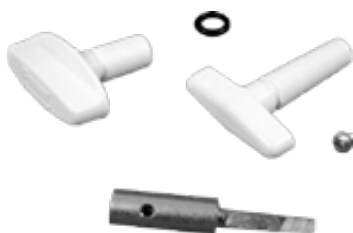

FIAMMA HANDLE EXT TURBO VENT

008620

Extension for the winder handle on the Fiamma vents and Turbo vents. Using different combinations of the handle, plus the extension.

SPECIFICATIONS

- The roof thickness can be up to 85mm
- White in colour



FIAMMA HATCH WINDER HANDLE

008614



FIAMMA HATCH OPENING HANDWHEEL

044134



FIAMMA TURBO VENT HATCH OPENING MECHANISM

008624

Opening mechanism suitable for Turbo Vent.



FIAMMA HATCH HANDLE/EXT. & SCREW

008625

FIAMMA ROOF HATCH SPARE PARTS



FIAMMA FLYSCREEN T/S 280 X 280

035539

For vent 28.

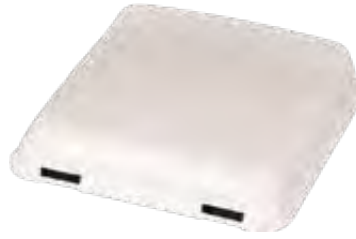

FIAMMA WHITE COVER

050397 SUITS OLD STYLE TURBO VENT

051663 WHITE COVER FOR 28F

051664 CRYSTAL COVER FOR 28F

For vent 28.



ROLLO VENT

042095

For vent 50.

SPECIFICATIONS

- Replacement flyscreen/blind for Fiamma 50 x 50 vent 008636 / 008637
- Ivory



VENT OPENING & CLOSING MECHANISM

044270

Suits 008640 or 050969

280mm x 280mm Fiamma vents.

ROOF HATCHES



ROOF HATCH - ELIXIR WHITE 9 X 9"

003578

Compact and lightweight, ideal for providing air flow in small areas such as kitchens or bathrooms. Suitable for caravans and motorhomes.

FEATURES

- Opens with the included handle to 45° and when closed sits only 30mm above the roof top
- Waterproof
- Weatherproof
- Rustproof

SPECIFICATIONS

- Adjustable inner trim allowing for most roof thicknesses
- 228mm x 228mm (9"x9") cut out size



JENSEN ROOF HATCH WHT 14 X 14"

008581

Ideal to allow air to flow in/out of RV vehicle.

FEATURES

- Self-centering device eliminates installation guess work and assures perfect alignment in roof opening
- Radius corners are standard
- Screen allows air through while keeping insects out
- Acrylic UV resistant translucent lid
- One piece seamless frame with a deep drawn painted metal base

SPECIFICATIONS

- Injection moulded garnish - accommodates a variety of roof thicknesses
- White



JENSEN ROOF VENT 12V 14 X 14"

008589

Ideal to extract air out of the RV.

FEATURES

- Self-centering device eliminates installation guess work and assures perfect alignment in roof opening
- Radius corners are standard
- Screen allows air through while keeping insects out
- Acrylic UV resistant translucent lid
- 12V exhaust fan with switch
- White



ELIXIR 12V ROOF VENT 14 X 14"

008603

This roof vent is fitted with a 12V fan to extract unwanted steam and exhaust fumes. Ideal for caravans or motorhomes.

FEATURES

- Self-centering metal base with radius corners
- Interior garnish with wider 1 1/4" flange
- Galvanised metal base
- 12V Fan
- Positive-seal weather stripping

SPECIFICATIONS

- Universal
- One piece metal frame, deep drawn metal base



ELIXIR GALVANISED HATCH 14 X 14

036651

New and Improved design. One-piece seam-less self-centering metal base with interior garnish and wider 1-1/4" flange & radius corners fits all existing roof openings covering existing screw holes. Covers interior stains left by former garnish rings.

- Galvanised lid
- 14x14

ROOF HATCH SPARE PARTS

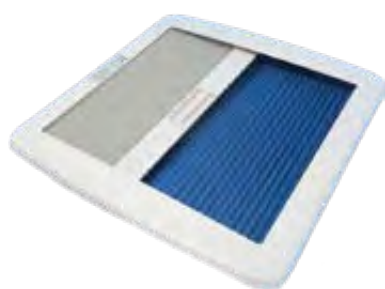

MINI HEKI SCREEN AND BLIND

035467

Dometic Mini Heki Hatch - Internal blind and screen in frame.

SPECIFICATIONS

- To fit standard MINI heki 400 x 400 roof vent.
- Outside measurement is approx 520 x 520
- Colour: Off-white / Cream



MILLARD HANDLE T/S HATCH & WOW

008567

Millard Hatch Handle Black PVC ,LARGE HOLE. These are made for the OLD style windup millard hatches, however they can be used to replace window winders from the three louvre Millard or York windows.

FEATURES

- The is a 10mm dia hole with one flat side and an allen key grub screw



JENSEN LID 14" - "OLD STYLE"

008582

Replacement lid for Jensen Roof Vent 355mm.

SPECIFICATIONS

- 4 attachment spigots - pin hinged (pin not included)



JENSEN LID 14" - "NEW STYLE" 008583

Replacement lid for current Jensen Roof Vent 355mm.

FEATURES

- Grooved/slotted hinge spigots
- Central metal brace is removed during installation
- Plastic is 335mm square and low profile
- Easy to replace by removing the central metal slide by screws from above. This releases hatch which can then pivot over hinge. The metal slide is moved up or down until it can slip over the end of winder mechanism

SPECIFICATIONS

- Dimensions: 355mm(w) x 355mm(d)



JENSEN FLY SCREEN 14" STANDARD NEW STYLE 008585

Replacement fly screen to suit 12V or standard Jensen hatch.

SPECIFICATIONS

- Distance from inside edge of frame to winder hole is 50mm.



JENSEN ELIX-HANDLE 14IN HATCH 008586

Elixir / Jensen Winder Handle Suit Mechanical lift, WHITE Aluminium handle approx 50mm from screw centre to handle centre.



JENSEN ELIXIR HATCH MECH 008587

Elixir/Jensen Winder Mech to suit various size Elixir roof vents.



ELIXIR LID 14" - OLD STYLE 008591

Replacement lid to suit 12V or standard Elixir hatch. Centre bar is riveted to lid and metal slide bar (difference between the Elixir old style lid and the new style lid).

SPECIFICATIONS

- Suits Elixir PVC roof vent 355mm x 355mm
- White
- Rolled metal hinge



ELIXIR LID 14" - NEW STYLE 008592

Replacement lid to suit 12V or standard Elixir hatch.

SPECIFICATIONS

- Suits Elixir PVC roof vent 355mm x 355mm
- White
- 'C' shaped aluminium hinge



ELIXIR HATCH WINDING HANDLE 008593

- Butterfly style
- Old style

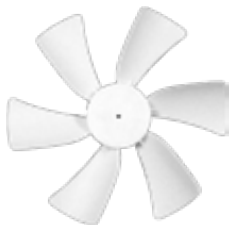

JENSEN ELIXIR - FAN BLADE 12V HATCH 008588

Elixir Roof Vent Fan Blade Only. Fits the Elixir fan motor with shaft dia of 3mm with one flat side. Also fits the Jensen Hatch.

SPECIFICATIONS

- Fan is six inches in diameter (150mm)
- Shaft hole is 1/8 inch diameter (3.2mm)



ELIXIR 14IN FLYSCREEN 008595

Elixir Flyscreen Only. The flyscreens that suit the ELIXIR and JENSEN are NOT the same. Check the dimensions of the location of the winder hole to ensure you select the correct screen.

SPECIFICATIONS

- Distance from inside edge of frame to winder hole is 70mm
- Hole diameter is 13mm
- These actually measure 345mm x 345mm



ELIXIR 14IN INTERNAL TRIM

008596

SPECIFICATIONS

- Replaces your old tired, faded trim to look brand new
- Suits elixir hatch only



ELIXIR 12V MOTOR ONLY

008604

SPECIFICATIONS

- Replacement RV model
- For Jensen or Elixir 12v exhaust hatches



JENSEN DOME SEAL

043642

Jensen Dome Seal 48 Inch Fits Metal Vent.

SPECIFICATIONS

- Replaces old brittle seal to create a better contact with the lid



JENSEN PUSH BUTTON SWITCH

043643

Jensen Push Button Switch Black On Off Switch. Suits 12V exhaust hatch.



REMIS ROOF HATCH FLYSCREEN

033665

This is the flyscreen only that fits the REMIS 400mm x 400mm hatch.

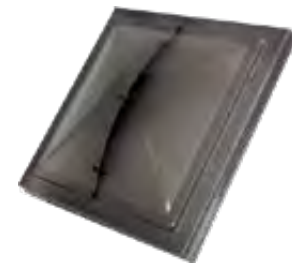

JENSEN HATCH LID

051673

Replacement Vent Lid for Jensen Plastic Base Vent is made of a durable plastic and comes pre-assembled for a quick install.

FEATURES

- Works with 14" x 14" Jensen roof vents
- Colour: Smoke
- Includes: 1-Vent lid and pin hinge

VENTS & COWLS



PLASTIC VENT

007965 145 X 230MM

007966 175 X 207MM

007968 150 X 230MM

007969 150 X 230MM

007971 145 X 230MM

Suitable for cupboards and pantries or any enclosed space that requires ventilation.

SPECIFICATIONS

- Removable with mesh
- White



SOLAR EXHAUST VENT PVC

008563

FEATURES

- Weatherproof
- Solar powered exhaust vent
- Extracts up to 680 cu ft of air per hour in bright sunlight
- Will also work successfully in natural daylight
- No wiring or running costs



ALUMINIUM VENT

Painted aluminium vents are available in smooth white or stucco white. Each louvre provides approximately 600 square mm of venting. The number of louvres per vertical row varies with height. When ordering vents please nominate required size by stating height and width.

SPECIFICATIONS

- 190mm wide vent feature 1 vertical row of venting
- 381mm wide vent feature 2 vertical rows of venting
- 572mm wide vent feature 3 vertical rows of venting
- 762mm vent feature 4 vertical rows of venting
- 953mm wide vent feature 4 vertical rows of venting
- White

SMOOTH WHITE

CODE	SIZE
016452	95MM X 190MM
016456	133MM X 190MM
016460	210MM X 190MM
016464	210MM X 381MM
016468	286MM X 572MM
016472	324MM X 381MM
016476	629MM X 381MM
016483	629MM X 572MM
016487	705MM X 572MM
016494	705MM X 762MM
016500	705MM X 953MM
016506	705MM X 1143MM

STUCCO WHITE

CODE	SIZE
016454	95MM X 190MM
016462	210MM X 190MM
016466	210MM X 381MM
016470	286MM X 572MM
016485	629MM X 572MM



MULLER VENT - PLASTIC

016519

FEATURES

- Teardrop shaped plastic exhaust ventilator
- Venturi technique extracts air even while vehicle is stationary
- Dimensions: 285mm(l) x 185mm(w)



VENT SEA BIRD PLASTIC

016520

FEATURES

- Generates large airflow
- Either intake or exhaust
- Waterproof

SPECIFICATIONS

- Dimensions: 190mm(l) x 110mm(h) x 145mm(w)



PLASTIC LOUVRE VENT

016525 70 X 445 BLACK
016527 125 X 260 BLACK
016528 125 X 260 WHITE

Suitable for cupboards and pantries or any enclosed space that requires ventilation.



FLUSH PLASTIC VENT

016530 90 X 90 WHITE
044944 90 X 90 BLACK

Suitable for lockers, doors, cupboards.

SPECIFICATIONS

- Dimension: 90mm(l) x 90mm(h)
- White or black



BLOWER VENT 90MM X 90MM

016533

SPECIFICATIONS

- 75mm tail plastic
- Dimensions: 90mm x 90mm
- White



STAINLESS STEEL VENT

016539 SINGLE 127MM X 65MM
016540 SINGLE 127MM X 115MM
016541 SINGLE 127MM X 227MM
016542 DOUBLE 227MM X 115MM



ROTARY VENT HODGES

016543 PLASTIC
016544 METAL

Cutaway: 100mm hole. Wind powered. Exhausts air when spinning.



ROSE VENT

016548 PLASTIC
016549 ALUMINIUM

SPECIFICATIONS

- Used for cross flow ventilation
- Adjustable opening vent
- Often used with rotary vent to close off exhaust



SCUPPER VENT SMALL

016550

Used to scoop in air under pressure from forward travel. Suitable for RV vehicles.

SPECIFICATIONS

- Dimensions: 170mm(w) x 113mm(d)
- White
- Sits 22mm above roof line



SCUPPER VENT LARGE - WHITE

016554

Used to scoop in air under pressure from forward travel. Suitable for RV vehicles.

SPECIFICATIONS

- Dimensions: 240mm(w) x 146mm(d)
- Sits 20mm above roof line



VENT CENTAUR

035299 SMALL 190MM X 100MM

016510 MEDIUM 215MM X 165MM

Black Centaur 623 vents are ideal for caravans and RV vehicles as a pressure hatch.

FEATURES

- The frame and springs require just 10mm clearance below the outside mounting and the supplied internal finger grip extends just 18mm below the outside front face
- Opens to 30 degrees and extends 80mm above the outside mounting
- Positive dust and waterproof seal when closed
- Black lid



ALI ROOF COWL

016581 SMALL 140MM WIDE. COVERS 70MM HOLE

016583 MEDIUM 190MM WIDE. COVERS 125MM HOLE

016585 LARGE 240MM WIDE. COVERS 160MM HOLE

The roof cowl (outer section) sits on the roof, providing a waterproof vent.



INSERT ROOF COWL

016582 SMALL 75MM

016584 MEDIUM - LARGE 150MM



WHITE BLOWER VENT 127 X 127

051237

SPECIFICATIONS

- White
- Suits hose: 100mm
- Protrusion: 19mm
- Intrusion: 31mm

VENTS & COWLS SPARE PARTS



SCUPPER VENT SPRING

016557 SPARE SPRING SUIT SMALL SCUPPER VENT

016558 SPARE SPRING SUIT LARGE SCUPPER VENT



SCUPPER VENT INTERNAL TRIM

016561 S/SMALL VENT TRIM 40MM ROOF THICKNESS

016563 S/LARGE VENT TRIM 40MM ROOF THICKNESS

016562 S/LARGE VENT TRIM 50MM ROOF THICKNESS

Colour: White

PREMIUM ODOUR CONTROL

PORTA-PAK[®] EXPRESS

Cassette Tank Deodoriser and Cleaner

- Number one portion control product worldwide
- Unbeatable odour prevention
- Breaks down waste & paper
- Cleans holding tanks & sensors
- Formaldehyde-free
- Fresh scent, lavender breeze

PORTA-POR[®]

Liquid Cassette Tank Treatment

- Commercial strength deodoriser
- Breaks down waste and paper
- Cleans holding tank & sensors
- Effective in black & grey tanks
- Formaldehyde-free
- Non-staining dye
- Orange twist fragrance
- Two sizes available: 6 pack of 120ml bottles & 960ml bottle

BIO-PAK[®] EXPRESS

Natural Cassette Tank Deodoriser & Digester

- Rapid breakdown of waste & paper, eliminating need for special tissue.
- Advanced enzyme formula removes odours & cleans tank
- Environmentally & septic tank safe
- Formaldehyde-free & biocide free
- Alpine fresh, tropical breeze

ELEMONATE[®]

Grey Water Deodoriser

- Rapid dissolving tablet
- Deodorises & freshens drain lines
- Dissolves grease & organic sludge
- Cleans greywater tank sensors
- Biodegradable & formaldehyde-free
- Safe on equipment, valves & seals

COMMANDO[®]

Cassette Tank & Sensor Cleaner

- Removes odour & waste build-up in 12 to 24 hours!
- Super-concentrated natural enzyme formula
- Breaks down waste & paper in holding tanks
- Continued use keeps tanks healthy & in good working condition
- Biodegradable & formaldehyde-free



@WalexAdventures



Wherever the road
takes you,
take Walex.



@WalexAdventures



@WalexAdventures

enturdventures



SANITATION

Consumables	173
Portable Toilets	175
Fixed Toilets	176
Fixed Toilets Fittings.	178
Holding Tanks & Accessories	180

CONSUMABLES



BIO-PAK EXPRESS 15 SACHETS

039899 GREEN CITRUS
043395 TROPICAL BREEZE

Natural enzyme deodoriser and waste digester for cassette and portable toilets. Pre-packaged portion control. The advanced enzyme formula of Bio-Pak Express removes odours and cleans the holding tank with rapid breakdown of waste and paper.

FEATURES

- Septic tank safe
- Dissolves quickly
- 100% biodegradable
- Suitable for all cassette toilets, holding tanks and portable toilets
- Easy to use
- Easy to handle

SPECIFICATIONS

- 15 water soluble sachets
- One sachet treats waste in holding tanks from 10 to 25 litres



TOP TANX RINSE

050975

FEATURES

- Minimises odour build up
- Lubricates seals and bowls
- Formaldehyde free
- Each dose 90ml
- 10 Treatments per bottle



PORTA-PAK EXPRESS 15 SACHETS

040873 OCEAN BREEZE
042688 LAVENDER

Porta-Pak Express deodoriser sachets utilise the Walex Wave2 odour control technology to deliver unsurpassed long-term odour prevention for all caravan, boat and recirculating toilet applications. Plus Porta-Pak Express provides the ease of use and convenience of a pre-packaged portion control system. The commercial strength water soluble sachet disperses quickly into water and will not clog pipes, pumps or valves. Continued use of PortaPak Express will keep your toilet odour free and hassle free. No need for messy liquids or chalky tablets.

FEATURES

- Easy to use
- Suitable for all cassette toilets, holding tanks and portable toilets
- 100% biodegradable
- Easy to handle
- Dissolves quickly

SPECIFICATIONS

- 15 water soluble sachets
- One sachet treats waste in holding tanks from 10 to 25 litres.



PORTA-POR LIQUID HOLDING TANK DEODORISER

050404 1 LITRE
050405 PORTA-POR 6 PACK

Porta-Por's 3-in-1 formaldehyde-free liquid performance, deodorises, breaks down paper and waste, and cleans tanks with just one dosage. Its super concentrated formula is perfect for the ultimate week long odor control - Just Pour It In!

It's easy! If you have the 960ml bottle pour 30ml of Porta-Por into the toilet holding tank by flushing or direct add. If you have the 120ml bottles pour 60ml into the toilet holding tank by flushing or direct add.

FEATURES

- Concentrated Liquid Formula
- Commercial Strength Deodorisation
- Breaks Down Waste & Paper
- Cleans Holding Tank & Sensors
- Available in 2 sizes: 6 pack of 120ml bottles (12 treatments) & 960ml bottle (32 treatments)
- Formaldehyde-free & Biodegradable
- Orange twist Fragrance



WALEX COMMANDO

044727 BLACK HOLDING TANK TREATMENT

FEATURES

- Removes residual waste build-up that can cause inaccurate sensor readings and residual odours.
- Removes build-up and odours in as little as 12 hours.
- Super-concentrated, scientifically developed formula with natural enzymes to penetrate and break down waste and paper build-up
- Use to remove existing build-up or prevent build-up accumulation
- Continued use of Commando every 3 months will help keep your tank in good working condition

SPECIFICATIONS

- Pack of 4 drop ins



ELEMONATE GREY WATER DEODORISER

042689 LEMON

Drop the tablet into the sink and run water over it for a few seconds to dissolve. Each tablet treats up to 180L grey water tank.

FEATURES

- Elemonate will keep your grey water tank and drain lines open, flowing and odour-free
- Enzymes dissolve grease and sludge
- Tablets dissolve rapidly
- Freshens sink and drain lines
- Deodorises the grey water tank
- Pleasant lemon scent
- Quick dissolving tablets
- Biodegradable
- Not suitable for toilets
- 5 tablets per bag



AQUA KEM PREMIUM 2LT

035585 GREEN

Non-toxic holding tank deodorant. Biologically stimulates the breakdown of toilet waste in the waste-holding tank.

FEATURES

- Environment friendly
- Pleasant citrus scent
- Assists in breaking down solids



FIAMMA SUPER KEM BLUE 2LT

001792

Concentrated double action formula deodorises and sanitises.

FEATURES

- Suitable for fixed or portable toilets
- Deodorises and sanitises
- Pine essence scented

AQUA KEM CONCENTRATE

051645 GREEN

051646 BLUE

051647 LAVENDER



Significantly improves the liquifying of waste for easier tank emptying, and the breakdown of toilet tissue to prevent clogging. New concentrated formula.



AQUA RINSE

041412 PLUS 2L

043615 SPRAY 500ML

The famous pink toilet fluid from Thetford that keeps your flush water fresh and ensures that your toilet flushes effectively. Aqua Rinse prevents deposits from forming in the flush-water tank and bowl, ultimately making toilet cleaning faster and easier. It also promotes easier opening and closing of the toilet blade, ensuring a smooth flush and no water leakage between flushes, helping to save water. Spray specifically designed for vehicles with a fixed toilet connected to the central water tank.

FEATURES

- Leaves a protective layer preventing deposits forming
- Environmentally friendly – Awarded the Dutch & German Environmental seal
- Dosage 100mL per 15L flush tank capacity
- Biodegradable Septic Tank safe, able to be emptied on the ground & in caravan park septic tanks
- Spray the inside of the toilet bowl before or after flushing the toilet



AQUA KEM BLUE / LAVENDER 2LT

035586 BLUE

044609 LAVENDER

A powerful and easy to use additive for waste holding tanks. It can be used in cassette toilets as well as Porta Potti's. Its formula is derived not only to suppress unpleasant smells and reduce gas build-up, but also to break down solids and toilet tissue. To use, simply pour 150ml into a 20 litre holding tank. Ad 2-3 litres of water to ensure optimum performance. Refresh every 4-5 days.

FEATURES

- Pleasant, pine (blue) or lavender scent (purple) with outstanding odour control



FIAMMA TOILET TISSUE

035583

Ideal for portable and cassette toilets thanks to its dissolving formula. Stronger and softer tissue that dissolves quickly in water

FEATURES

- Quickly disintegrates after use
- Strong and soft

SPECIFICATIONS

- 300 sheets per roll
- Pack of 6
- Won't clog up tanks or waste valves

PORTABLE TOILETS



CAMEC PORTABLE TOILET

044062 10LT

044063 20LT

FEATURES

- 12 litre fresh water top tank on both
- Full-size seat and lid for comfort and support
- Detachable holding tank with large discharge opening
- Empties in one easy motion
- Easy to clean, matte finish
- One piece tank constructed from high density polyethylene material, will not leak
- Leaks and odours prevented by double sealed valve
- Heavy duty side clips to securely fasten both tanks together

SPECIFICATIONS - 10 LITRE

- Dimensions: 365mm(w) x 300mm(h) x 415mm(d)
- Capacity: 10 litre waste holding bottom tank
- Weight: 4.8kg

SPECIFICATIONS - 20 LITRE

- Dimensions: 365mm(w) x 420mm(h) x 415mm(d)
- Capacity: 20 litre waste holding bottom tank
- Weight: 5.7kg

CAMEC CARRY BAG PORTABLE TOILET

042936 10LT

042937 20LT

Carry handles to make transporting your Camec Portable Toilet even easier!

FEATURES

- Heavy duty fabric

SPECIFICATIONS

- 10 Litre: 430mm(h) x 370mm(w) x 320mm(d)
- 20 Litre: 430mm(h) x 370mm(w) x 430mm(d)

CAMEC TOILET SPARE PARTS

042500 SEAT & LID

042501 SLIDE VALVE

042502 FRESHWATER CAP

042503 WASTE CAP

042504 SEAL

042505 CLIP



PORTA POTTI QUBE

040453 145 - GREY

040454 165 - GREY

040455 335 - WHITE HDK

040456 345 - WHITE

040457 365 - PISTON FLUSH

Made from light but tough plastic, these Porta Potti's are hermetically sealed. Cleaning is also made easy thanks to detachable toilet seats. Features lid clips and a vent button for 'no splash' emptying and a holding tank indicator.

PORTA POTTI EXCELLENCE

040459 GRANITE

Stylish good looks, functional 443mm seat height and features a built-in toilet roll holder, tank level indicator and an integrated seat cover lock.

SPECIFICATIONS

- Dimensions: 448mm(w) x 388mm(h) x 450mm(d)
- Weight: 5.5kg
- Seating height: 443mm
- Flushing System: piston

NESSCO PORTABLE TOILET

041774

Compact size, easy to dismantle for complete hygienic and odour control cleaning. Exclusive safe connecting valve makes it easy to operate and easy to dismantle with maximum hygienic control. Sturdy lower tank and made in one piece so there is no chance of leakage. Sturdy and solid handle. This toilet features a large waste cap, no complicated protrusion. Convenient side hooks connect the upper tank to the lower tank.

SPECIFICATIONS

- Dimensions 340mm(h) 360mm(l) x 435mm(d)
- Weight 4.8kg
- Fresh water tank holds 15ltrs
- Holding tank holds 13ltrs
- Weight: 5.20kg

CARRY BAG PORTA POTTI

042846

FEATURES

- Fits most brands of portable toilet
- Easy to carry and provides discreet storage

SPECIFICATIONS

- Dimensions: 390mm(l) x 430mm(w) x 440mm(d)
- Genuine Thetford Porta Potti brand

FIXED TOILETS



DOMETIC CASSETTE TOILET

041697

The internal ceramic bowl is inside the plastic unit of the CTS 4110. It makes your sanitation system easy to clean and scratch-resistant which ensures an unsoiled appearance for many years. Identical with household toilets in shape and height, the CTS 4110 offers top comfort. For maximum flexibility the seat can be rotated stepwise up to 90 degrees, making corner installation possible.

FEATURES

- Easy-to-transport holding tank equipped with wheels and telescopic handle
- 19 litres waste tank
- Press button to flush
- Tank level indicator shows when 3/4 full and full
- Pivoting outlet connection
- Warning signal when the tank is removed
- Stable and reliable construction
- 1 year warranty

SPECIFICATIONS

- Cassette Entry: Rear
- Flush: Electric - Plumbed
- Waste Tank Capacity: 19 litres
- Dimensions: 382(w)mm x 672mm(h) x 530mm(d)
- Seat Height: 505mm
- Total Height - Seat Open: 875mm
- Weight: 12kg
- Swivel Seat: Yes - 180 degrees



ZADI LOCK

051508

Replacement barrel and key to suit the Thetford Access doors.

FEATURES

- An alternate solution is to use the Camec One Key Solution



PORTA POTTI CASSETTE HOLDING TANKS

040960 C250 HOLDING TANK

001868 HOLDING TANK R/H

001870 HOLDING TANK L/H

034799 R/H CASS HOLDING TANK S/C400

034800 L/H CASS HOLDING TANK S/C400

001880 HOLDING TANK S/C200



PORTA POTTI CASSETTE SWIVEL

001878 MANUAL WHITE

001879 ELECTRONIC WHITE

Compact and versatile design. The toilet bowl can be swiveled 180 degrees. Easy access to the rear mounted cassette holding tank via the lockable access door in the side of RV. Choice of either a fully self contained model, or one that is plumbed into the RV's general purpose water supply.

FEATURES

- Toilet bowl can be swiveled 180 degrees to provide extra space
- Can be fully self contained or connected into the water supply
- 17 litre holding tank



THETFORD TOILET CASSETTE C220 SERIES

050299

Genuine replacement waste cassette to suit Thetford C220 series toilets.

FEATURES

- Take Care - This will NOT fit any other toilet - Check Specifications
- Wheels & Pull Handle
- 1 year warranty



ZADI HOUSING WHITE

051509

Replacement housing for Thetford access doors.

FEATURES

- Includes white housing, spring and blue retainer



C-263 CERAMIC BOWL

041122



PORTA POTTI CASSETTE C402C

001888 R/H 12V WHITE

001889 L/H 12V WHITE

A holding tank with wheels and a convenient retractable handle are just two of the features of this built-in bench style model. The working mechanism in the holding tank is removable so the inside of the tank is easy to clean and maintain. An advanced level indicator display shows the levels in the waste holding tank. Can be installed on the left or right for maximum versatility.

FEATURES

- Electric push button flush
- Holding tank level indicator
- Waste holding tank on wheels
- LED display indicates when waste tank is full

SPECIFICATIONS

- Dimensions: 670mm(w) x 522mm (846mm when lid is open)(h) x 400mm(d) (270mm at base)
- Weight: 8.1kg / 12 Volt
- Waste Tank Capacity: 19.3 Litre (5.1gal)
- Flush Water Tank Capacity: 15 Litre (4 gal)
- LH/RH facing away from the toilet
- Has its own flush water tank that is filled from the outside



BRAVURA TOILET HIGH

001941

FEATURES

- Floor mounted toilet
- Draws flush water from an independent pressurized water supply
- Waste tank located beneath or on the floor (not included)

SPECIFICATIONS

- Large and convenient single pedal flush
- Pulsating flush provides superior, near instantaneous full-bowl washdown
- Universal floor flange - mount on any flange
- Waste tank capacity dependent on vehicle's waste tank
- Attractive styling that's easy to clean

PORTA POTTI CASS C400 SPARE PARTS

CODE	PRODUCT NAME
033911	BELLOWS S/001878 TOILET C4
035898	WATER FILL EXT
042049	TANK VENT BUTTON



PORTA POTTI CASS C402 SPARE PARTS

CODE	PRODUCT NAME
036763	CONTROL PANEL
041037	HANDLE SHAFT
040331	LH TANK MECHANISM
040332	RH TANK MECHANISM
041410	HT REED SWITCH

PORTA POTTI CASS CS200 SPARE PARTS

CODE	PRODUCT NAME
001881	VACUUM BREAKER
001883	C200 SADDLE BRACKET
001884	FLUSH HANDLE
001886	FLUSH SWITCH
001920	C200 LIP SEAL
026351	C200 MANUAL PUMP
040428	C200 FLOAT ARM
042293	C200 REED SWITCH

PORTA POTTI CASS DOORS

CODE	PRODUCT NAME
001875	DOOR 3 WHITE GREY
001876	DOOR 4 WHITE GREY
001877	DOOR 5 WHITE GREY
034472	DOOR 6 WHITE GREY
043632	DOOR 3 BLACK
043633	DOOR 4 BLACK

PORTA POTTI GENERAL CASS SPARE PARTS

CODE	PRODUCT NAME
001896	SEAT & COVER WHITE
001902	SWIVEL LED INDICATOR
001903	W/TANK MEASURING CUP
001904	PUMP KIT 12V SUB
001906	WATER CAP
001907	DRAIN CAP
001908	DUMP CAP
001910	SLIDING COVER
001911	LEVEL INDICATOR
001917	AUTO H/TANK VENT
001919	LIP SEAL MANUAL
001926	MECH ASSY MOON GREY
001928	VENT SEAL
001930	MICRO SWITCH
001932	FUSE 3AMP-PK/2
001933	FLUSH KNOB ASSEMBLY

PORTA POTTI CASS C2 SPARE PARTS

CODE	PRODUCT NAME
034043	WIRING HARNESS
036768	TANK BLADE MECH

FIAMMA BI-POT SPARE PARTS

CODE	PRODUCT NAME
001796	WASTE/WATER CAP
001797	CAP SEAL O/S
001799	PUMP PLUNGER
001801	SEAT & LID
001805	SIDE CATCH
001806	SLIDE VALVE N/S
001807	TOP SEAL O/S
001808	BOTTOM SEAL O/S
001810	SL/VALVE O RING

PORTA POTTI SPARE PARTS

CODE	PRODUCT NAME
001849	BELLOWS
001857	VENT SEAL
001861	265 WASTE CAP
040684	335 WATER CAP
042349	EXCEL BASE PLATE
041502	PORTA POTTI CASS - C250/260 SEAT & COVER
041943	PORTA POTTI CASS - C250 SLIDING COVER
042789	PORTA POTTI C250 C260 HOLDING TANK MEC



BRAVURA TOILET WATER MODULE
026353



BRAVURA SPARE PARTS
040648 TOILET SEAL KIT



ELECTRA MAGIC
002009 SLIDE VALVE
041506 COVER - SEAT ASSY
To suit Electra Magic 12 and 24V toilet.

FIXED TOILET FITTINGS



ADAPTOR SCREW ON W - RAISED LIP
035597

Adaptor Screw On with raised lip, T01959. Contains 4 locating lugs on underside, plus a raised circular lip on the underside as well. Suit Thetford fittings.



ADAPTOR THREAD BOTH END
035596

SPECIFICATIONS

- 75 x 250 (L)
- Male 3 inch thread both ends



THETFORD SPARE PARTS
002013 CLOSET FLANGE SEAL
002014 BAYONET RING
002015 CAP AND WIRE
002022 SLIDE VALVE KIT ABS
002029 STR BUMPER HOSE ADAPT



VALTERRA FLANGE ADAPT FEMALE THREAD
002066

SPECIFICATIONS

- 3 inch



VALTERRA FLOOR FLANGE FEMALE THREADED
002035



VALTERRA SLIDE VALVE & CAP M/THREAD
002049

SPECIFICATIONS

- 3 inch male thread



SEWER HOSE
002083 10FT NO FITTINGS
002084 20FT NO FITTINGS

Evacuation sewer hose to fit 75mm Valterra and Thetford fittings.



VALTERRA SLIDE VALVE & CAP F/THREAD
002047

SPECIFICATIONS

- 3 inch female thread



VALTERRA SEAL REPLACEMENT
040875

SPECIFICATIONS

- 3 inch

**VALTERRA FLANGE BAYONET****040876****SPECIFICATIONS**

- 3 inch

**VALTERRA STRAIGHT SEWER HOSE ADAPTOR****002086**

Sewer hose connection to suit 75mm evacuation hose. Use a 3" clamp.

**HOSE ADAPTOR 45 DEGREE****040877**

Valterra sewer hose connection to suit 75mm evacuation hose.

FEATURES

- These provide a 45 degree angle outlet connection for the hose. The inside dia where it attaches to the lugs is 89mm. Fitting includes a rubber seal and should be clamped with a 75mm hose clamp (not included)

SPECIFICATIONS

- Colour: Black

**VALTERRA EZ COUPLER VALVE****040610**

Adapts drain hose to valve system with four bayonet attachments for a leak proof seal. Twist right onto your RV sewer hose.

**VALTERRA NO FUSS FLUSH****040609**

Jet stream spray removes and flushes away tank deposit when installed permanently to waste or grey water tank.

**VALTERRA SLIDE VALVE & CAP****002048**

Valterra slide valve (Black) to suit 75mm evacuation hose. Manual operated gate valve to seal toilet evacuation hose. Includes quick fit cap. The outside diameter where the cap attaches to the lugs is 89mm.

**VALTERRA DRAIN HOSE CAP****040385**

Fits all 76mm bayonet fittings with a simple twist-on connection, keeping storage compartment clean.

**VALTERRA RV HYDROFLUSH 90DEG****040604**

Breaks up plugged tanks, cleans tank, pipe, valve, drain hose, and includes an internal back flow preventer. 90° fits in tight spaces.

**VALVE TERMINATION CAP & STRAP****002057**

Help keep a lid on things that need to be kept inside, with a valve termination cap and strap made with high quality plastics to seal toilet waste tanks.

**VALTERRA WATER DRAIN ADAPTOR****040386**

Allows for grey water sewer hook-up using 1/2" or 5/8" waste water hose.

HOLDING TANKS & ACCESSORIES



EZ COUPLER CAP & HANDLE

002090

SPECIFICATIONS

- Colour: Black
- Makes removal of the black water cap easier
- Keeps hands away from waste water



QUICK CONNECTOR KIT - VAC PACK

002089

Comes with 76mm hose adapter and bayonet fitting as well as 2 x hose clamps.



UNIVERSAL SEWER HOSE ADAPTOR

002091

Universal adaptor. 76mm Thetford hooks and 76mm standard bay lugs.

FEATURES

- Converts Thetford system to Valterra/ Grentec/ Anonda



FIAMMA ROLL - TANK

040602 23 LITRE

A convenient portable 23 litre water tank with total discharge cap. Compact size (fits through normal vehicle doors). Wheels make moving easy.

002178 40 LITRE - 3KG

40 litre waste tank with level indicator and air release valve. Filling and discharging are performed through a Sanitary-Flex Drain Tube (not included).

FEATURES OF 40LITRE

- Wheels make moving easy
- Level indicator
- Air release valve and 45 degree angle adapter for discharge

SPECIFICATIONS

- Weight: 5kg



FIAMMA QUICK CONNECTION

040751

To suit Fiamma Roll Tank 23 Litre (refer code 040602).



FIAMMA LEVEL INDICATOR

040896

SPECIFICATIONS

- 40 LT roll tank spare



WASTE HOLDING TANK

002179 68LT

002180 128LT

002181 170LT

002182 255LT

Robust roto moulded polyethylene tanks threaded to suit 76mm inlet and 38mm outlet/breather.

FEATURES

- Made from 10mm thick polyethylene
- Complete with vent fitting
- No slide valve

Hot Water Units	181
Tanks, Containers, Accessories	183
Hoses & Filters	189
Plumbing Fittings	194
Pumps	200
Bathroom Modules	206
Sinks & Basins	207
Tapware	209
Filtration	215
Gas Compliance & Safety	216
Gas Copper Pipe & Fasteners	217
Gas Fittings & Adaptors	217
Gas Cylinders & Products	221
Gas Hoses	222
Gas Regulators	223

HOT WATER UNITS

CAMEC DIGITAL INSTANTANEOUS GAS HOT WATER SYSTEM

- 051459 13KW GAS WATER HEATER WHITE DOOR
- 051460 13KW GAS WATER HEATER BLACK DOOR

Instantaneous Water Heater system is an economical solution for RV's to supply constant hot water. Unlike 240V systems that draw extensive current, clever design of this system means it can operate for many hours at maximum heating capacity from just one 9kg gas bottle! The digital controller gives you flexibility to set your desired water temperature plus peace of mind knowing the water temperature can be controlled so it will not be too hot for children. One of the key benefits of an RV instantaneous water heater is that gas is only used when water flows (the water heater is activated by the initial flow of water through the system). In other storage tank systems, energy is required on a continual basis to keep the water stored at the desired temperature and with an instantaneous system, you are able to use all of the available water in your RV's storage tank(s).

FEATURES

- Designed specifically for RV use
- Australian Gas and Watermark Approvals
- Operates from 12V DC & Gas
- Continuous hot water flow
- Remote digital temperature controller with error code display and on/off switch
- Up to 60% less gas consumption than regular tank models
- No anode to replace
- Door lock compatible with Camec One Key System
- Door lock compatible with Camec One Key System
- Easy to install and suits most existing water heater cut outs
- Patented rain protection exhaust
- Low power and gas usage



SPECIFICATIONS

- Super-efficient 46,500BTU heating power
- Weight 12.1kg
- Installation cut-out dimensions: 330mm(w) x 330mm(h) x 380mm(d)
- Water temperature selectable from 35-60°C
- Minimum starting water flow: 1.5l/min
- Shut down water flow: 1.0 l/min
- Temperature rise at 5.0L/min water flow: 37.7°C
- Power requirement: 10.5-15V DC
- Maximum current 1.5A
- Nominal Gas Consumption (MJ/h): 49.1
- Efficiency: >90%

CAMEC WATER HEATER SPARE PARTS

CODE	PRODUCT NAME
043994	HWS WHITE SPARE DOOR ONLY
043995	HWS BLACK SPARE DOOR ONLY
044746	CAMEC IWH HEAT EXCHANGER
044747	CAMEC IWH BURNER
044748	CAMEC IWH SILICON TUBE 300MM
044749	CAMEC IWH WATER FLOW SENSOR
044750	CAMEC IWH WATER INLET
044751	CAMEC IWH WATER DRAIN VALVE
044752	CAMEC IWH PRESS RELIEF VALVE
044753	CAMEC IWH THERMOSTAT
044754	CAMEC IWH AIR PRESSURE SWITCH
044755	CAMEC IWH GAS VALVE
044756	CAMEC IWH IGNITOR 12V B121(IS)
044757	CAMEC IWH DIGITAL CONTROLLER
044758	CAMEC IWH ELECTRONIC CTRL UNIT
044759	CAMEC IWH MAIN WIRE HARNESS
044760	CAMEC IWH 12V POWER LEAD
044761	CAMEC IWH DISPLAY CABLE SHORT
044762	CAMEC IWH DISPLAY CABLE 5M
044763	CAMEC IWH COLD WATER SENSOR
044764	CAMEC IWH HOT WATER SENSOR
044765	CAMEC IWH EXHAUST PIPE
044894	CAMEC IWH VENTILATOR

**MAGNESIUM ANODE ROD****035975 SOLD LOOSE****044044 RETAIL PACKAGING**

Slightly acidic water is fine to drink and wash with, but it can degenerate your water heater over time. Some water heaters have an in-built anode rod of soft metal that will break down instead of the other components of the water heater. Anodes should be replaced when they have degraded more than 75%, usually yearly, but this is dependent on the quality of water used.

FEATURES

- Magnesium AZ31
- To suit Suburban hot water systems

SPECIFICATIONS FOR 044044

- Size: 17mm x 235mm
- Thread: 3/4" NPT

SPECIFICATIONS FOR 035975

- 21.30mm x 300mm
- Thread: 3/4" BSP

**SUBURBAN 240V ELEMENT
1440W****040710**

Suburban 240V Element 1440W, 6amp, will suit SW6DEA, SW5EA & SW4DEA.

SPECIFICATIONS

- 240V Element
- 1440W, 6amp
- Thread 1 inch NPT (32.4mm outside diameter)

**SOCKET 1 1/16INCH****043383**

To replace suburban anodes

TANKS, CONTAINERS, ACCESSORIES



TANK CLEEN 200G

000261

Cleans and deodorises freshwater tanks.

FEATURES

- An effective remedy for water tainting problems
- Treats up to 182 litres

SPECIFICATIONS

- 200gm



2.5M LEAD T/S WATER MONITOR

006133

Extension lead for 040282, 040283, 040284, Water Tank Sender Probes



LED WATER TANK GAUGE/VOLTMETER

043453 SINGLE WATER TANK GAUGE LCD

043454 1 WATER LVL & 1 BATTERY GAUGE

043455 DOUBLE WATER TANK GAUGE LCD

043456 2 WATER LVL & 1 BATTERY GAUGE

043457 TRIPLE WATER TANK GAUGE LCD

These gauges have a coloured LCD analogue display with LED backlighting for crystal clear viewing. Only 50mA draw so they can be left on without flattening your on-board battery. There is a power on/off switch to turn the gauge off when the caravan is not in use.

FEATURES

- Monitors water tank, either metal or plastic
- Five levels are indicated on display
- Constant display of levels without needing to press a button
- On/Off switch when caravan is not being used

SPECIFICATIONS

- Dimensions: 108mm x 108mm
- From 10 to 20mm thick
- 12V connection and tank plug entry at rear requires a cutout 50mm wide x 20mm high
- Colour of needle changes to red and flashes at the lowest (RES) level
- Sender probes for water tanks not included
See 040282/040283/040284/006116



WATER TANK SENDER PROBE

040282 2.5M

040283 5.0M

040284 7.5M

SPECIFICATIONS

- Water tank sender probe for use with RV Traveler
- LED Tank Gauge for "under chassis low profile tanks"
- 3 different length cables available to suit Sp installation requirements.



WATER TANK SENDER PROBE KIT

006116

To suit deeper tanks - 5 probes are mounted into the side of the tank (fresh or grey water only). Supplied with wiring kit, one junction box and 5m lead.

FEATURES

For under chassis low profile tanks, please use either code 040282, 2.5m probe, code 040283, 5m probe, or code 040284, 7.5m probe



WATER TANK GAUGE

006118 1 TANK

006119 2 TANKS

006120 3 TANKS

Simple monitoring of fresh or grey water. One kit per tank required.

FEATURES

- For under chassis low profile tanks, please use either code 040282, 2.5m probe, code 040283, 5m probe, or code 040284, 7.5m probe
- For deep tanks please use code 006116, tank sender probe kit



WATER AND WASTE GAUGE

006121

Simple monitoring of fresh and grey water
Incorporates its own battery power supply and no connection to vehicle's power supply is required.
One probe kit per tank required.

FEATURES

- For water sender probes - under chassis low profile tank, please use code 040282, 2.5m probe, or code 040283, 5m probe or 040284, 7.5m probe
- For deep tanks please use code 006116, tank sender probe kit
- 2 gauges - 1 water / 1 waste



JRV WATER

006139 JRV FRESH WATER TANK MONITOR

006144 JRV WATER MONITOR FRESH/GREY/BL

006147 JRV WATER TANK MONITOR BLACK

FEATURES

- These systems allow the tank level monitoring of fresh water, grey water, black water.
- Includes sender probes



SINGLE WATER TANK GAUGE

051213

You now have the ability to customise the kit to suit your requirements with a range of single tank, double tank and triple tank gauges to be matched with 2.5 metre, 5 metre or 7.5 metre lead sender probes. With one push of the test button you are able to monitor the water levels of up to three tanks.

There is no need to wire in a 12 volt supply as the top indicator gauge comes complete with its own battery, which is easily replaced when the need arises.

The water gauge measures only H65mm x W65mm x D11mm so it is small enough to fit any application.

SPECIFICATIONS

- 1 Sender Probe Required



DOUBLE WATER TANK GAUGE

051214

You now have the ability to customise the kit to suit your requirements with a range of single tank, double tank and triple tank gauges to be matched with 2.5 metre, 5 metre or 7.5 metre lead sender probes. With one push of the test button you are able to monitor the water levels of up to three tanks.

There is no need to wire in a 12 volt supply as the top indicator gauge comes complete with its own battery, which is easily replaced when the need arises.

The water gauge measures only H65mm x W65mm x D11mm so it is small enough to fit any application.

SPECIFICATIONS

- 2 Sender Probes Required not included
See 040282/040283/040284/006116



TRIPLE WATER TANK GAUGE

051215

You now have the ability to customise the kit to suit your requirements with a range of single tank, double tank and triple tank gauges to be matched with 2.5 metre, 5 metre or 7.5 metre lead sender probes. With one push of the test button you are able to monitor the water levels of up to three tanks.

There is no need to wire in a 12 volt supply as the top indicator gauge comes complete with its own battery, which is easily replaced when the need arises.

The water gauge measures only H65mm x W65mm x D11mm so it is small enough to fit any application.

SPECIFICATIONS

- 3 Sender Probes Required



MODULAR 43 LITRE WATER TANK

- 043394 WATER TANK 43L MODULAR
- 043708 MODULAR TANK A INC FITTINGS
- 043709 MODULAR TANK B INC FITTINGS
- 043410 CAP 20MM 3/4 FBSP
- 043411 GE20 ELBOW 20MM 3/4 FBSP
- 043412 REDUCING SOCKET 25 TO 20MM
- 043414 ADAPTOR 20 FBSP TO 15 MBSP
- 043426 TEE FITTING 3/4 F BSP

The modular caravan and RV tank is blow moulded from food contact approved, high molecular weight, high density polyethylene. This makes the tank a super tough performer. Moulded with two integral 20mm (3/4 MBSP) threads that can accept a wide variety of standard fixtures and fittings. Using these standard fittings, the tanks can be networked together to provide almost limitless water storage options for your vehicle.

SPECIFICATIONS

- 2 x 3/4 (20mm) MBSP
- Dimensions: 260mm(w) x 220mm(d) x 860mm(l)
- When installation configuration has been chosen, drill a 3-4mm hole in the top of each tank to allow for air venting



UNIVERSAL WATER /WASTE TANK

044267

Blow moulded universal caravan and RV water tank which can be configured in many ways to provide a single low cost solution to your water or grey water storage requirements. Blow moulded from food contact approved high molecular weight high density polyethylene. This makes the tank a super tough performer. The tank is moulded with two integral 40mm (1 1/2" BSP) threaded female closures that can accept a wide variety of standard fixtures and fittings. Using these standard fittings the tank can be networked together to provide many water storage options for your vehicle. When installation configuration has been chosen, drill a 3-4mm hole in the top of each tank to allow for air venting.

SPECIFICATIONS

- Weight: 2.5kg
- 1 1/2" BSP
- Dimensions: 698mm(l) x 210mm(d) x 382mm(w)



ALKO 11.5 GL WATER TANK 52 LT

006089

Plastic, tough, non toxic fresh water tank for caravans and recreational vehicles.

FEATURES

- Has two small drilled breather holes (no thread) on the upper corner of the tank
- The top also has two tapered red plastic push in bungs that cover holes left from the manufacturing process

SPECIFICATIONS

- Dimensions: 1010mm(l) x 175mm(h) x 330mm(w)
- Capacity: 52 litres (11.5 gallons)



ROTO CAMPER 55 LITRE WATER TANK (NO BARBS)

006096

Plastic fresh water tank for caravans and recreational vehicles.

FEATURES

- Australian made from food contact approved resin

SPECIFICATIONS

- Dimensions: 760mm(l) x 350mm(h) x 230mm(d)
- Capacity: 55 litre (12 gallons)
- Can be installed vertically or horizontally on the long side
- No barbs
- 3/4" BSP FEM inlet
- 2 x 3/8" BSP FEM (vent and outlet)



WATER TANK

- 033422 136L-59LT 1/2BSP OUTLETS
- 033423 186L-82LT 1/2BSP OUTLETS

Plastic fresh water tank, tough, non-toxic. Used by Australian caravan manufacturers.

FEATURES

- High density polyethylene
- Foodgrade

SPECIFICATIONS

- Tank comes with two 1/2" BSP plugs
- Outlets are 2 x 1/2" female BSP
- Inlet 25mm barb
- 006083 Screw in breather to suit (not included)
- 59LT = 840 x 480 x 180mm
- 82LT = 1190 x 480 x 180mm
- For breather use 006083



ROTO 61 LITRE ROUND CORNER WATER TANK

006097

Plastic, tough, non toxic, fresh water round corner tank for caravans and recreational vehicles.

FEATURES

- Australian made from food contact approved resin

SPECIFICATIONS

- Dimensions: 900mm(l) x 490mm(w) x 175mm(d)
- Capacity: 61 litre (13 gallons)
- Outlet: 1/2" barb
- Inlet: 1" barb
- Drilled breather hole

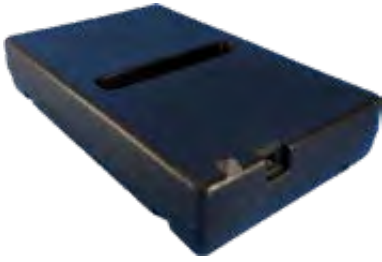

ROTO 70 LITRE WATER TANK (NO BARBS)

006099

Plastic fresh water tank for caravans and recreational vehicles.

FEATURES

- Australian made from food contact approved polyethylene

SPECIFICATIONS

- Dimensions: 860mm(l) x 525mm(w) x 165mm(d)
- Capacity: 70 litre (15 gallons)
- No barbs
- Inlet 3/4" F thread
- Outlet 3/8" F thread
- Small drilled breather hole



ROTO 84 LITRE WATER TANK

006100

Tough, non toxic standard fresh water tank for caravans and recreational vehicles.

FEATURES

- Australian made from food contact approved resin
- 860L x 525W x 220H



WATERTANK 95 LITRE

050593

This 95L Universal Water Tank can be setup as either a Fresh Water or Grey Water Tank using the associated fitting kit

FEATURES

- Offset flush point allowing for 100% flushing of tank
- Fitting Kits available for Fresh or Grey Water Setups

SPECIFICATIONS

- Capacity: 95 Litres
- Dimensions(mm): 1170 x 500 x 220

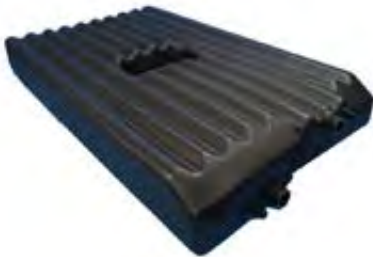

WATERTANK 110 LITRE

050595

This water tank has a 110L capacity and can be setup as either a Fresh Water or Grey Water tank using the associated fitting kit

FEATURES

- Specialty Mounting Brackets Available
- Can be used as a Fresh or Grey Water Tank

SPECIFICATIONS

- Capacity: 110L
- Dimensions(mm): 1200 x 650 x 180



WATER TANK MOUNTING BRACKETS

035609 FOR 61 LITRE, 006097/033422 TANKS

035610 FOR 70 LITRE, 006099 TANK

035611 FOR 84 LITRE, 006100 TANK

035612 FOR 100 LITRE

035613 FOR 127 LITRE

044379 FOR 50 LITRE, 044267 TANK



WATERTANK BRACKETS

050608

Mounting Brackets to suit Camec's 110L Universal water tank 050595.

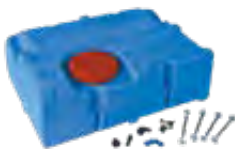

FIAMMA WATER TANK 70L -R

051320

The Fiamma 70Lt fresh water tank is made of non-toxic material and can be installed either vertically or horizontally. Comes with 38mm inlet and all necessary fittings for installation.



WATERTANK FITTINGS 95F

050605

This kit includes all the required fittings to setup Camec's 95L universal water tank as a Fresh Water Tank.

FEATURES

- 25mm Barb Inlet
- 40mm Cap
- 20mm Plug
- 13mm Outlet
- 13mm Breather



WATERTANK FITTINGS 95G

050604

This kit includes all the required fittings to setup Camec's 95L Universal water tank as a Grey Water Tank.

SPECIFICATIONS

- 40mm Ball Valve
- 13mm Breather
- 40mm Inlet Adaptor
- 2 x 20mm Plug



WATERTANK FITTINGS F110

050607

This kit includes all the required fittings to setup Camec's 110L Universal water tank as a Fresh Water Tank.

SPECIFICATIONS

- 25mm Barb Inlet fittings
- 40mm Cap
- 13mm Breather
- 12mm Outlet (JG fittings)



WATERTANK FITTINGS G110

050606

This kit includes all the required fittings to setup Camec's 110L universal water tank as a Grey Water Tank.

SPECIFICATIONS

- 40mm Ball Valve
- 1/2" BSP CAP
- 13mm Breather
- 40mm Inlet Adaptor



CAMEC WATER TANK BARB OUTLET DRILLED

006079

To suit Camec water tanks 006096/006099

SPECIFICATIONS

- 1/2" barb x 3/8" BSP



CAMEC WATER TANK BARB PLUG UNDRILLED

006080

To suit Camec water tanks.

SPECIFICATIONS

- 1/2" barb x 3/8" BSP



DRAIN CAP FOR CAMEC MK2 WATER TANK

006087

SPECIFICATIONS

- 1/2" female BSP thread



TEE FOR CAMEC MK2 55LT WATER TANK

006088

SPECIFICATIONS

- 1/2" BSP male to 2 x 25mm hose barb fittings



1/2" PLUG BSP

042652

To suit Camec Water Tanks.



WATER TANK PLUG

051265



CAMEC WATER TANK DRAIN TAP

043772

To suit Camec water tanks, twin thread

SPECIFICATIONS

- 3/8" BSPM x 1/2" male barb
- 1/2" BSPM if required



BARREL UNION

044375

1 1/2" FMBSP UNION



BARREL UNION NIPPLES

044374

1 1/2" MBSP NIPPLE



1/2 IN BSPT PLUG

033427



PLASTIC BUSH 1/2 BSPM X 3/8 BSPF

033881

To suit Camec 033422, 033423 water tanks. To reduce outlets to 3/8" BSP female.



BREATHER 10MM BARB X 3/4 MALE BSP

006083

Suits 033422 and 033423 water tanks

HOSES & FILLERS

SPEEDFIT TWIST AND LOCK RANGE PLUMBING FITTINGS

The Twist and Lock range of WaterMarked plumbing fittings were designed for use in normal domestic plumbing applications in accordance with 'AS/NZS 3500', 'AS 4176 (ISO 15875/21003)'. The 12mm range is popular with the caravan and motor home market.

An additional benefit the Twist and Lock range offers is that a twist of the screw cap locks the pipe into place and gives increased compression on the O-Ring for even greater security.



12MM COLLET CLIP - WATERMARKED

044127 BLUE
044128 RED

Use on watermarked fittings for easy identification of hot or cold water



12MM ELBOW CONNECTOR - WATERMARKED

044129

12MM pipe



12MM END STOP - WATERMARKED

044122

12MM pipe



12MM EQUAL TEE CONNECTOR - WATERMARKED

044117

12MM pipe



12MM INSERT SUITE BPEX - WATERMARKED

044125

12MM pipe. Recommended for all connections to ensure pipe stays round. Especially after cutting.



12MM STEM ELBOW - WATERMARKED

044118

12MM pipe



12MM STEM TEE - WATERMARKED

044121

12MM pipe



STRAIGHT CONNECTOR - WATERMARKED

044130

12MM pipe



12MM X 1/2" BSP ELBOW TAP CONNECTOR - WATERMARKED

044120

12MM X 1/2" BSP female



STRAIGHT TAP CONNECTOR - WATERMARKED

044119

12MM X 1/2" BSP female



BRASS STRAIGHT ADAPTOR - WATERMARKED

044123

12MM X 1/2" BSP male



FEMALE ADAPTOR - WATERMARKED

044124

12MM X 3/8" female BSP



ELBOW CONNECTOR 15MM PIPE - WATERMARKED

050609

SPECIFICATIONS

- Fitting Direction 90°
- Fitting Type Elbow
- Suits 15mm pipe



BRASS UNIVERSAL HOSE ADAPTOR

042691



BRASS EZ HOSE CONNECTOR

042692



FLOOR SEAL T/S HOSE 10-19MM OD

040868

SPECIFICATIONS

- White
- To suit hose 10-19mm outer diameter
- Pack of 100



FLUTED WASTE/SULLAGE HOSE

005280 BLACK CORRUGATED HOSE 25MM ID

044459 HOSE FLUTED WASTE 25MM X 10M ROLL

005284 HOSE FLUTED WASTE 25MM X 20M

043365 SULLAGE HOSE 28MM X 10M ROLL

044072 HOSE FLUTED WASTE 32MM X 20M

This hose uses nitrile to minimise the permeation of odours through the hose when used with sanitation systems in boats, caravans and recreational vehicles.

FEATURES

- Excellent UV resistance to withstand extreme Australian conditions
- Ribbed outer cover provides superior resistance to abrasion
- Recommended for water applications where a long lasting hose is required
- Black



CAMEC DRINKING WATER HOSE

005303 12MM X 10M

005301 12MM X 20M

005304 12MM X 100M (SOLD PER METRE)

Non toxic, no taste. Hose will not taint the water.

SPECIFICATIONS

- Plastic fittings attached for easy connection to a garden tap on 10m and 20m rolls
- Weight: 10m - 1.3kg
- Weight: 20m - 2.11kg



BLACK VINYL FOOD GRADE HOSE

005267 12.5MM X 30M X 2MM WALL

005269 25MM X 30M X 3.5 WALL

Ideal for RV plumbing and many other applications.

FEATURES

- Complies with Australian standards
- Use where plumbing may be exposed to light to reduce algae growth

SPECIFICATIONS

- Internal diameters of 12.5 and 25mm
- Will withstand temperatures from -10°C up to 60°C
- Smooth bore and outer surface



HOSE BAG

044486 SMALL

044485 LARGE

Small bag holds 10m of fresh or 5m of sullage hose. Large bag holds 20m of fresh or 10m of sullage hose.



CLEAR VINYL FOOD GRADE HOSE

- 035559 CVT 10MM 30M
- 005272 VINYL CVT 12MM 30M
- 005274 VINYL CVT 25MM 30M

Ideal for RV plumbing and many other applications. Clear hose is best used in areas not exposed to light.



MULTI-REEL LARGE & COMPACT

- 043265 LARGE REEL
- 005313 COMPACT REEL

SPECIFICATIONS - LARGE

- Ready for your power lead or other uses.
- 37 cm diameter
- 44 cm including handle
- 8 cm deep
- 0.9 kg when empty
- Approx. 30m power cord capacity

SPECIFICATIONS - COMPACT

- 34cm diameter including handle
- 6.5cm deep
- 0.6kg when empty. Holds approx 15m power cord



CAP ONLY TO SUIT FIAMMA WATER FILTER

- 043326 WHITE WITH KEY
- 043327 BLACK WITH KEY

Replacement locking water cap



RECESS WATER FILLER & CAP

006176

To suit Camec water tanks.

SPECIFICATIONS

- White
- Commonly used on retro/vintage caravans
- Suits 25mm filler hose



HOSE FLAT DRINKING WATER

- 005309 HOSE FLAT DRINKING WATER 10M
- 005310 HOSE FLAT DRINKING WATER 15M

Ideal for connection to caravans and motor homes using snap-on high quality brass fittings.

FEATURES

- High flow
- Food grade liner
- Solid brass fittings
- Tangle free storage
- Complete with reel

SPECIFICATIONS

- Internal diameter of 19mm, which provides a high flow
- Weight: 10m - 2.05kg
- Weight: 15m - 3.0kg



FIAMMA LOCKABLE WATER FILLER

- 006169 BLACK
- 006170 WHITE

Locking water cap.

SPECIFICATIONS

- Requires 80-82mm hose
- 10mm barb for breather
- 40mm barb for filler hose



WATER FILLER

- 006173 COMPLETE FILLER
- 006174 FLAP ONLY

Plastic water filled with hinged flap. Suits 25mm filler hose



CAMEC LOCKABLE WATER FILLER

- 039945 WHITE RIGHT HAND HINGE
- 039946 BLACK RIGHT HAND HINGE
- 040269 WHITE LEFT HAND HINGE
- 040270 BLACK LEFT HAND HINGE

Lockable water filler supplied with 2 keys.

FEATURES

- One piece filler neck
- Lockable water filler supplied with two keys
- Camec One Key Fits All barrel housing
- Available in both left and right hand hinged flap
- Flap opens 180° to be flush with the RV wall
- Emergency opening feature from the inside

SPECIFICATIONS

- 10mm barb for breather hose
- 25mm barb for filler hose
- Requires 85mm hole



HOSE FLAT SULLAGE

- 038685 6M 25MM ID
- 005315 9M 25MM ID
- 005316 9M 32MM ID

For general use on caravans and motor homes.

FEATURES

- For grey water disposal
- Smooth surface for easy cleaning
- No seeping
- Save on space
- Complete with multi reel

SPECIFICATIONS

- Weight: 6m - 1.9kg
- Weight: 9m - 2.6kg
- Weight: 9m x 32mm - 3.2kg



REPLACEMENT CAP & KEY LOCKABLE WATER FILLER

- 006160 WHITE
- 006161 BLACK



IN LINE PRESSURE REDUCER

051095

350KPa
15MM FXF

Fitted in line to prevent over pressure conditions
Pressure limited to 50psi out



SHURFLO CITY WATER ENTRY

006150 CITY WATER PRESS CONTROL CAP ONLY

006154 WHITE

006155 WHITE RETAIL PACK

006156 CHROME

006158 CHROME RETAIL PACK

043432 BLACK

043433 BLACK RETAIL PACK

Combined mains pressure water entry, pressure regulator and check valve. Reduces mains pressure to 50psi.

FEATURES

- Leak tight, stress and crack resistant
- Quick, easy wall mount

SPECIFICATIONS

- Water pressure is limited to 50psi



BRASS ADAPTOR CLICK ON 11/16" USA THREAD

005399

FEATURES

- Click-on 1 1/16" American thread
- Used on Shurflo City Water entry



CITY WATER ENTRY FITTING

005398 PLASTIC

Snap on hose fitting to suit the SHURflo In-line Water Entry.

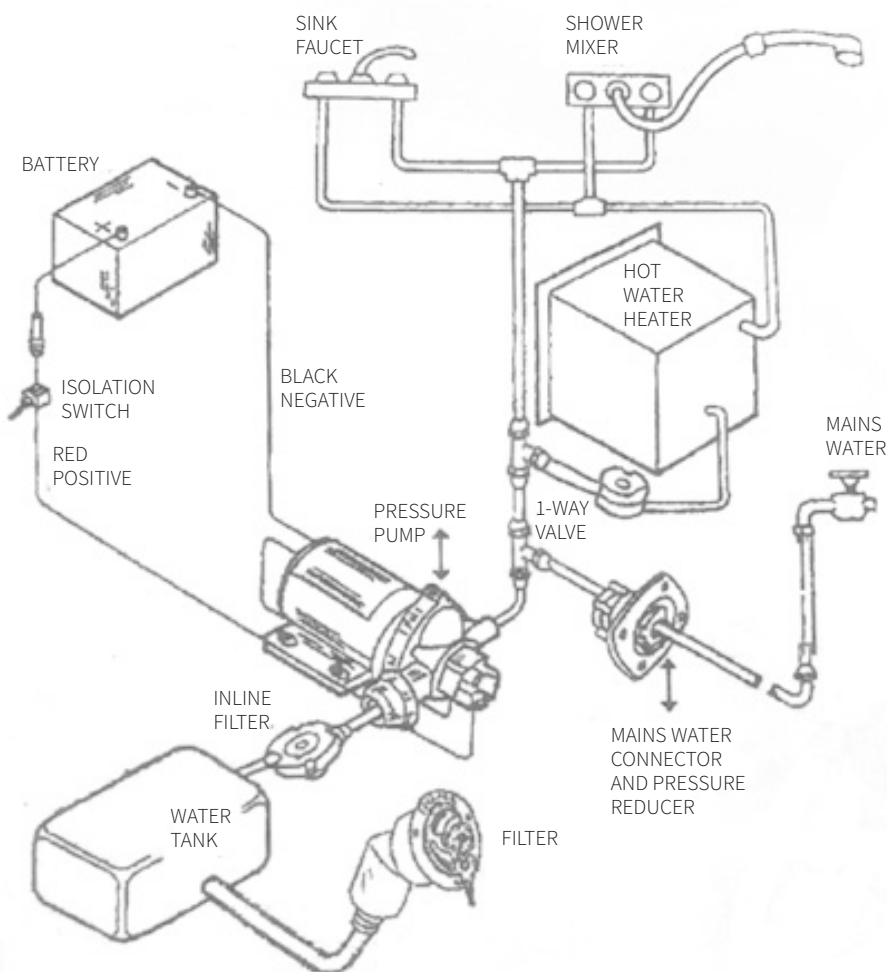

ACETAL METRIC FITTINGS

The PM range of fittings are manufactured from an acetal copolymer with food grade nitrile O-rings. Being especially produced for food stuffs and potable liquids

HOW SUPER SPEEDFIT WORKS

To make a connection, the tube is simply pushed in by hand; the unique patented John Guest collet locking system then holds the tube firmly in place without deforming it or restricting flow.

MATERIALS OF CONSTRUCTION

Super Speedfit fittings are made up of three components:

Bodies - are produced in an acetal copolymer or polypropylene.

'O' rings - are Nitrile rubber or EPDM

Collets - are produced in acetal copolymer or polypropylene with stainless steel

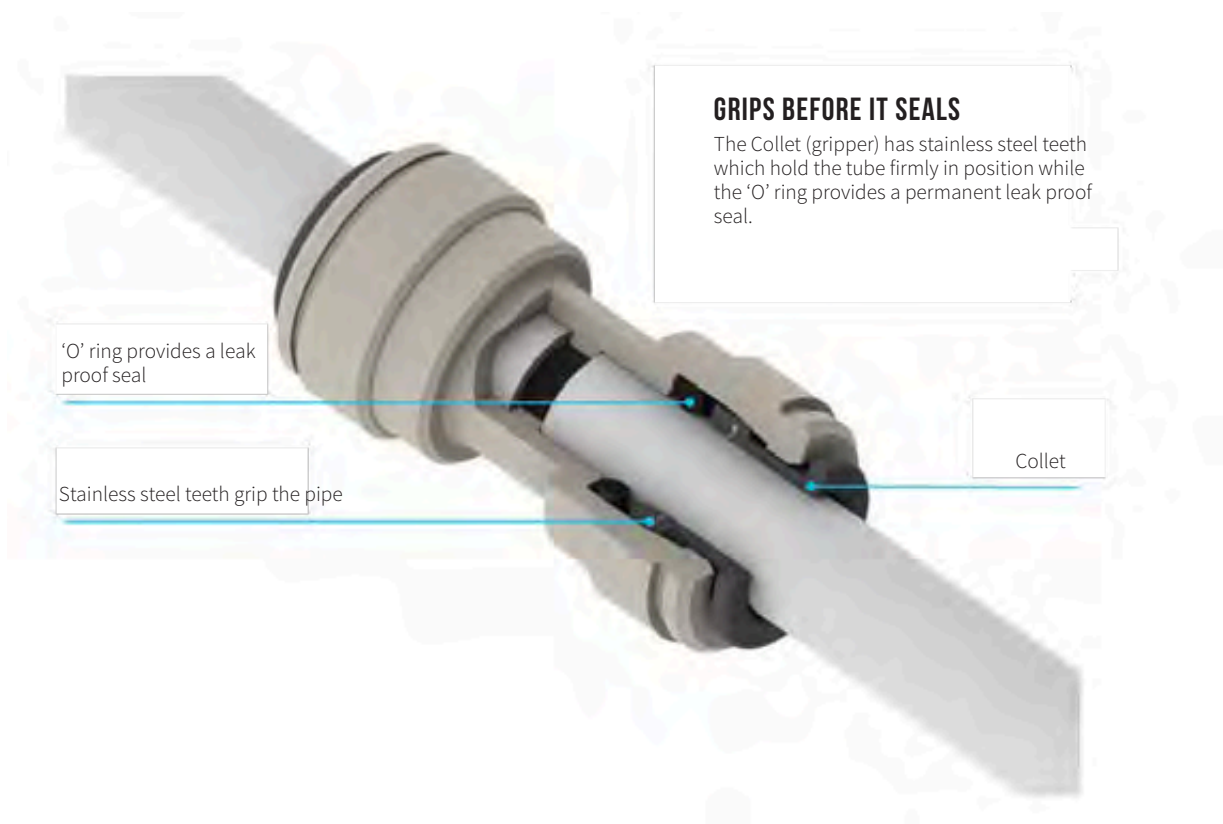

GRIPS BEFORE IT SEALS

The Collet (gripper) has stainless steel teeth which hold the tube firmly in position while the 'O' ring provides a permanent leak proof seal.

'O' ring provides a leak proof seal

Stainless steel teeth grip the pipe

Collet

HOW TO MAKE A CONNECTION



CUT THE TUBE SQUARE

Cut the tube square and remove burrs and sharp edges. Ensure the outside diameter is free of score marks. For soft or thin walled tube we recommend the use of a tube insert.



PUSH THE TUBE STRIP

Push the tube into the fitting, to the tube stop.



PULL TO CHECK SECURE.

Pull on the tube to check it is secure. Test the system before use.

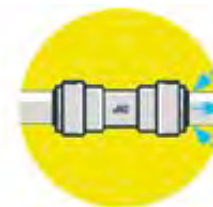

TO DISCONNECT

Push in collet and remove tube. To disconnect, ensure the system is depressurized, push the collet square against the fitting. With the collet held in position the tube can be removed

PLUMBING FITTINGS



REDUCING SOCKET 20 TO 15MM

043413



ELBOW BSP TO 12MM

005441 12MM X 1/2IN M/BSP (JG)
005434 12MM X 3/8IN M/BSP (JG)
042585 12MM X 1/2" M/BSP



ELBOW MALE/FEMALE 12MM X 12MM STEM

005440 (JG)

Elbow: 12mm pipe to 12mm stem



BPEX PIPE 50M - WATERMARKED

044126

SPECIFICATIONS

- 12MM
- 50M roll



ELBOW FEMALE CONNECTOR 12X12MM

005430 (JG)

Suits 12mm pipe



REDUCING CONNECTOR 12-10MM

005447

Plastic reducing adaptor from 12mm to 10mm pipe.



STRAIGHT CONNECTOR 12X12MM

005431 (JG)

Suits 12mm pipe



ADAPTOR STEM

005439

1/2" M/BSP x 12MM

Plastic stem adaptor to suit 12mm connectors



ADAPTOR FEMALE BSP

005433 12MM X 3/8" F/BSP (JG)
005436 12MM X 1/2" F/BSP (JG) |
051772 6MM X 1/4" BSP



ADAPTOR

005437 12MM X 3/8" M/BSP (JG)
005435 12MM X 1/2" M/BSP (JG)
042581 12MM X 1/2" M/BSP (JG) & O RING (JG)



BRASS ADAPTOR 12MM MALE BSP

005442

Used on hot water systems



BULKHEAD (JG) ADAPTOR 12MM

042059

"Thru wall" connection for 12mm John Guest pipe



UNION CONNECTOR

051774 6MM
051779 15MM



LOCKING CLIP 12MM - RED

005444 SUITS JG FITTINGS

Optional locking clip to fit 12mm push-on fittings.

FEATURES

- Prevents leaks or release when pipe is forced to a side
- Can be removed if the fitting is to be removed
- Essential if pipe does not meet fitting at correct angle

DM CLIP LOCKING 12MM - RED

005467 SUITS DM FITTINGS



EQUAL DIVIDER 12MM

038944

Splits a single inlet pipe into two separate lines.



TUBE SUPPORT INSERT - 12MM

005443

Inserted into JG pipe to ensure shape stays round and sits flush against the face of push-fit fittings. Recommended for all JG connections but especially on the hot water line.



STRAIGHT ADAPTOR

050992

12MM X 3/8 BSP



COLLET COVER 12MM - BLACK

005445

Prevents accidental removal or tampering with piping. Removable as required.



REDUCER 15MM X 12MM

005438

Reduces 15mm pipe to 12mm. 15mm male stem.



TEE CONNECTOR

005429 12MM

051776 6MM

Equal tee connector for JG 12mm pipe.



FLOW BEND CLIP

050991

Suits 12mm pipe



CONNECTOR 15MM X 1/2IN BARB

005432

15mm pipe to 1/2" ID PVC hose



SWIVEL ELBOW BRASS END

038790

1/2" male brass end with elbow to take 12mm pipe. Used on taps and water heaters



WATER 1/2IN BARB - HOSE

038657

Conversion from 12mm JG pipe to 12mm ID flexible hose. Chrome



JOHN GUEST TUBE 12MM LLDPE

005252 BLACK - 100MM

005254 RED - 100MM

005256 BLUE - 100MM

Linear Low Density Polyethylene for cold and intermittent hot water applications, water purification, water conditioners, ice makers and misting systems.

FEATURES

- Wide range of temperature and pressure suitability, broad chemical compatibility and made from non-contaminating materials
- Excellent resistance to environmental stress cracking as measured by ASTM D-1693 (10% IGEPAL)

SPECIFICATIONS

- Available per meter and as a 100 metre roll
- FDA compliant materials



BACK PLATE ELBOW

042781

Used to either add a tap to your A-Frame or accept mains pressure water into your caravan. This accepts a 15mm John Guest pipe on one side and allows a tap or inlet with 1/2 BSP thread to screw into threaded side.

FEATURES

- Suits 15mm pipes.
- Can be altered to suit 12mm pipe by using a 12mm Push-On to 15mm Push-In Smooth Adapter (sold separately).

SPECIFICATIONS

- Backing plate
- 15mm push-in fitting
- 1/2 Inch Female BSP thread



PLASTIC TUBE CUTTER

042584

Plastic tube cutter for 12MM plastic tubing.



JG PLASTIC PIPE CUTTER

051672

JG Pipe Cutter suitable for the cutting of JG Speedfit barrier pipe up to a 22mm Diameter. Cuts Speedfit Barrier Pipe, Nylon Pipe, Plastic Hose, Rubber Hose. The unique V-point blade pierces hard or soft plastic tubing. The blade then slices through to give a clean, easy cut with virtually no tube deformation. One squeeze does the job. Ergonomically designed handles.



SHUT OFF VALVE IN-LINE STRAIGHT

042583

12mm pipe fittings



BARREL UNION NIPPLES

050821

1" male thread both sides



CAMLOCK WITH 25MM BARB TYPE C

034817 FEMALE

034818 MALE

Female Camlock with 25mm barb used to connect two hoses with 25mm inner diameter when used in conjunction with equivalent female camlock.

FEATURES

- Supplied with R clips x 2 to lock in camlock
- Often used to join 25mm waste hose
- Polypropylene



RED PLUG 12MM

042782

Pushes into a 12mm JG push-fit fitting to terminate the line.



IN-LINE CHECK VALVE 12MM

042582

Push-on fitting to allow flow in one direction only.

FEATURES

- Prevents water returning down a pipe



HOSE CLAMP WORMDRIVE ALL ZINC FINISH

005330 10-16MM

005331 12-22MM

005332 20-32MM

005333 25-40MM

These general purpose hose clamps are ideal for hose sealing and use in many different applications with a high mechanical load.

FEATURES

- Improved asymmetric housing
- Screw support: Ease of assembly due to the safe guidance of the emerging band end
- Material and clamping range stamped on the band
- Asymmetric extension - prevents the housing from tilting over when the clamp is tightened

SPECIFICATIONS

- Screw and housing: Mild steel zinc plated and clear chromate



ELBOW CONNECTOR PUSH ON 15MM

050993



CONNECTOR PLASTIC HOSE FEMALE 12MM SNAP-IN

005415



PIPE RETAINING CLIP 12MM WIDE

042638 15MM

042639 27MM

042640 35MM

Single mount hole saddle with insulation to stop vibration.



HOSE CONNECTOR

042601 12MM X 1/2" HOSE - STANDARD
 042602 STOP 12MM X 1/2" HOSE - STOPS THE FLOW OF WATER WHEN DISCONNECTED



TAP ADAPTOR BSP UNIVERSAL

042603
 1" or 3/4" (with adaptor) female thread to click-on hose fitting



HOSE COUPLER 12MM 2 WAY

042604
 Joiner used to connect two clip-on hose fittings.



DIRECTOR

005354 10MM BARB X 1/2 M/BSP
 005355 13MM BARB X 1/4 M/BSP
 042641 13MM BARB X 1/2 M/BSP
 042651 13MM BARB X 3/4 M BSP
 042647 25MM BARB X 3/4 M/BSP
 042650 25MM BARB X 1 M/BSP



NUT AND TAIL 32MM

051467
 32mm barb to 1 1/4" female thread



NUT AND HOSE TAIL

044013
 40MM Barb x 1 1/2" FBSP
 Washer Included



DIRECTOR 32MM

051466
 32mm barb x 1 1/4" male thread



MALE HOSE TAIL

044373
 40mm BARB X 1 1/2" MBSP



ELBOW THREAD PLASTIC

005368 25M BARB X 3/4" MBSP
 042654 13MM BARB X 1/2" MBSP



ELBOW BARBED PLASTIC

042695 13MM
 042644 25MM



FEMALE ADAPTER

051135
 3/4" BSP female thread to 12mm JG hose



IN LINE FILTER PLASTIC 13MM

042648 13MM SHORT - 135MM OVERALL LENGTH
 042696 13MM LONG - 230MM OVERALL LENGTH

Perfect for tight spaces.



END STOP 12MM

050407 BLACK



FEMALE ADAPTOR

051317 12MM X 3/8 FBSP SHALLOW THREAD



JOINER

- 005371 BARBED JOINER X 10MM TAILS
- 042693 BARBED JOINER 13MM
- 042645 BARBED JOINER 25MM



JOINER 13MM HOSE X 3/4IN M/NPT

- 005411
- Fitted to the end of a hose to then suit the Shurflo City Water entry



JOINER 13MM HOSE X3/4IN F/NPT

- 005412
- Female fitting to suit 005411



NUT & TAIL

- 042658 3/4" BSP X 13MM BARB
- 042659 1" BSP X 13MM BARB
- 042646 1" BSP X 25MM BARB



PVC BALL VALVE

- 050820
- 1" female BSP threads



REDUCER

- 005378 REDUCER PLASTIC BARB 13MM TO 10MM
- 005382 REDUCER PLASTIC BARB 32MM TO 25MM
- 042657 BARBED JOINER REDUCING 25MM TO 19MM
- 051770 REDUCER 12MM TO 8MM
- 051771 REDUCER 8MM TO 6MM



REDUCING BUSH

- 050922
- 1 1/2" male thread to 3/4" female



REDUCING BUSH 40MM - 32MM

- 051468
- 1 1/2" male thread to 1 1/4" female thread



REDUCING NIPPLE

- 050923 40 X 20MM
- 1 1/2" female thread to 3/4" female thread



TEE

- 005383 BARBED TEE 10MM
- 042694 BARBED TEE 13MM
- 042649 BARBED TEE 25MM
- 051780 15MM



FEMALE CONNECTOR

- 051293 12MM X 3/8 BSP



MALE CONNECTOR

- 051773 6MM X 1/4" BSP
- 051778 15MM X 1/2" BSP



THREADED TEE FBSP 13MMX1/2

042653

13mm hose barb with 1/2" BSP male fitting



ONE-WAY VALVE (2313)

005798

One way valve to suit 10mm hose



SHURFLO INLINE CHECK VALVE 1/2 BARB

005789

Shurflo Non Return Valve. Safeguards against back surge up to 100PSI, suitable for most pump systems. 12mm clamp on hose.



BARBED SHUT OFF VALVE

042643 13MM

042655 25MM



NON RETURN VALVE 25MM PVC

035606

FEATURES

- Stepped ends to suit either 25mm or 38mm ID hose



TAP INLINE PLASTIC 13 X 13MM

005401

1/2" low density poly quick action valve - barbed at both ends.



WATER HEAT TEMPER VALVE

039244

This device is placed after the hot water system and mixes cold water when required to prevent water exceeding the temperature set.

FEATURES

- Tamper-proof adjustment, adjuster key prevents accidental adjustment
- Dezincification resistant
- Meets Australian Standard for potable water supply
- Individually tested and calibrated

SPECIFICATIONS

- Maximum of 50 degrees C.
- All threads are 1/2 inch male BSP



ADJ WATER PRESS REDUCING VALVE PRV15

039245

Protects downstream installations from variations in supply pressure. Adjustable 155-550kPA.



TEMPERING VALVE 12MM

042586

Designed to accurately regulate the temperature of water for activities such as showering, bathing and hand washing and reduces the risk of scalding. Ideal for caravan and RV plumbing.

FEATURES

- Lightweight and easy to install
- Preset to 50°C
- AS/NZ 4020 (water contract approval)



UNION ELBOW

051775 6MM



TUBE SUPPORT

051781 15MM



TUBE

051777 6MM NATURAL

050409 8MM WHITE

PUMPS



FLOJET 12V TRIPLEX PUMP C-TICK

041723 QUAD FITTINGS

The Flojet Triplex 12V Pump has 11 litres per minute water flow, 50 psi, automatic cut-off switch and is C-Tick approved. The pump is supplied with two Flojet quad port fittings that have been developed for the Australian RV market using John Guest and DM 12mm plumbing. The 12mm OD tube connects directly into each quad port fitting, eliminating the need to purchase adaptors. This not only saves cost but allows for quicker installation.

FEATURES

- C-Tick approved
- Supplied with 2 x quad port fittings to suit 12mm OD tube
- Automatic cut off switch
- Note: Filter sold separately to pump - refer code 041775

SPECIFICATIONS

- Dimensions: 200mm(l) x 130mm(h) x 120mm(w)
- Flow Rate: 11L/min
- Pressure: 50 psi
- Amps: 8 max
- Fittings: 2 x Quad to suit 12mm push-in pipe



FLOJET PUMP AND FILTER

005702 12V

043251 24V

Super quiet, reliable demand pumps. Complete with filter.

FEATURES

- Smooth operation without accumulator tank
- Permanent magnet, ball bearing motor
- Four chamber diaphragm design
- Corrosion resistant materials
- Includes bypass

SPECIFICATIONS

- Dimensions: 99mm(h) x 160mm(W) x 206mm(L)
- Flow Rate: 12.5L/min
- Pressure Switch: 15psi (1.1 bar) cut in - 35psi (2.5 bar) cut out
- Amp Draw: 3.9A
- Fittings: 1/2" barb, 1/2" thread. Snap in fittings



FLOJET 12V COMPACT PUMP 3/8" BARBS

005700

Compact, automatic shut off, 12V pump.

FEATURES:

- Self priming
- Dry running
- Soft, noise absorbing mounts
- Smooth operation without accumulator tank

SPECIFICATIONS

- Dimensions: 157mm(l) x 58mm(h) x 89mm(w)
- Weight: 1.6kg
- Flow Rate: 3.8L/min
- Pressure: 35 psi
- Voltage: 12V
- Amps: 4A
- Fittings: 3/8" barb, adaptor to 1/2" barb included



FLOJET 12V RV PUMP

005727

Self priming 12V diaphragm pump with 1/2" fittings.

FEATURES

- Self primes up to 2.4m vertical lift
- Four piston design delivers higher flow rates
- Quick connect plug-in ports for easy installation
- Pressure switch control to run the pump only as needed
- Includes an internal bypass to eliminate pulsating flow and switch chatter

SPECIFICATIONS

- Dimensions: 208mm(l) x 95mm(h) x 160mm(w)
- Weight: 2.03kg
- Flow Rate: 12.1L/min up to 17L/min
- Pressure Switch: 22psi cut in - 35psi cut out
- Voltage: 12V
- Amps: 7 max
- Fittings: 2 x straight Quad to 1/2" MBSP, 1 x straight Quad to 1/2" barb, 1 x elbow Quad to 1/2" barb



FLOJET FILTER 1/2" BARB FILTER QUAD PORT FITTED TO PUMP

005706

SPECIFICATIONS

- Filter (strainer) inlet, 12mm barb to Quad with elbow
- Plug in quad port 90° strainer allows for easy installation and compatibility



FLOJET 1/2 THREADED STRAIGHT

005711

1/2" BSP thread to quad



FLOJET 1/2 FITTING STRAIGHT PAIR OF QUAD FITTINGS

039903



FLOJET 1/2 BARB ELBOW

005704

Quick connect quad port fitting incorporating a 90° elbow with 1/2" barb.

**FLOJET INLINE FILTER****041775**

The Flojet 40 mesh filter has a quick connect quad port fitting to suit Flojet pumps and the filter mesh is easily removed for cleaning.

**FLOJET SIDE CLIPS****005710**

Replacement quad fitting clips for use on the flojet pumps. Sold per pair.

**FLOJET 1/2 BARB STRAIGHT UNION****005705**

Quad fitting to 1/2" barb

**FLOJET 3/4 BARB STRAIGHT****005709**

Quad fitting to 3/4" barb

**FLOJET 1/2 THREADED ELBOW****005707**

Quad fitting to 1/2" male bsp threaded elbow

**FLOJET 1/2 BARB IN-LINE FILTER****005712**

Removable cover for easy cleaning. 1/2" barbs

**FLOJET IN-LINE FILTER 1/2" MALE
THREAD BOTH ENDS****005724**

Removable cover for easy cleaning. 1/2" male thread fittings.

**FLOJET REPAIR KIT****005714****SPECIFICATIONS**

- Check valve assembly
- Diaphragm assembly
- Side clips
- Drive cam assembly

**FLOJET PRESS SWITCH ASSEMBLY - 35PSI****005716****FLOJET DIAPHRAGM KIT****005715**



FIAMMA ACCUMULATOR TANK A20

035603

May be used with most pump systems and may be mounted in any position.

SPECIFICATIONS

- Dimensions: 240mm(l) x 100mm(h) x 100mm(d)
- Universal expansion tank that eliminates pulsating pump operation and supplies a constant flow in the required quantity



SHURFLO AQUA KING PUMP

043430 12V

SHURflo Aqua King pump automatically senses when the tap has been switched on. Ideal for RV or marine applications. Reliable and quiet, it can run dry without damage.

FEATURES

- Multi-fixture applications
- Self-priming and sealed switch
- Seamless shell e-coated motor
- Ignition and thermally protected

SPECIFICATIONS

- Dimensions: 180mm(l) x 110mm(h) x 130mm(d)
- Flow Rate: 11.35L/min
- Pressure: 55psi
- Voltage: 12V
- Amps: 5 max
- Fittings: 1/2" MBSP



SHURFLO 12V 4009 STANDARD PUMP

040860 12V STANDARD UNBOXED

043243 12V STANDARD RETAIL BOXED

SHURflo's 4009 Series fresh water pump was created with a unique one piece diaphragm and internal bypass, assuring long life and top performance in all plumbing systems. The 4009 series pump is constructed for high flow demand, low noise and no rapid cycling. SHURflo's quality reputation has been built on the reliability and dependability of every pump they build. The 4009 series fresh water, automatic demand pump is quiet, thermally protected and can run dry without damage.

FEATURES

- Internal bypass will prevent rapid cycling
- C-Tick approved
- 4 chamber diaphragm pump

SPECIFICATIONS

- 12VDC permanent magnet
- Intermittent duty
- Shut Off: 45psi
- Dry Prime: 1.82m
- 11.3 LPM



SHURFLO 12V COMPACT PUMP

005698 UNBOXED

043241 RETAIL BOXED

This compact automatic demand fresh water pump offers durability and dependability making it ideal for low volume, intermittent duty applications. The 105 pump self-primers up to 2.0 vertical metres while delivering over 3.8Lpm. A 12V low power consumption motor, equipped with thermal protection and long life pressure switch rated to 30PSI, provides high pump performance and reliability.

FEATURES:

- Self primes up to 2.0m vertically while delivering up to 3.8L/min
- Perfect for low volume, intermittent duty applications
- Compact automatic demand pump
- Inlet and outlet: 10mm (3/8") barb



SHURFLO 12V COMPACT PUMP & TAP KIT

005699

Faucet offers smooth, easy flow with a washer-less ceramic disc design. Versatile 360 degree spout rotation.

SPECIFICATIONS

- Pump and switched faucet combined in the one kit



SHURFLO 4048 12V STANDARD PUMP ONLY

041554

Pump guarantees quiet operation and smooth performance while providing the ultimate in durability and reliability.

FEATURES

- Thermally protected
- Smooth flow

SPECIFICATIONS

- 15L/min
- Voltage: 12V
- Pressure: 55psi



SHURFLO 24V 4009 STANDARD PUMP ONLY

041556

These potable water pumps are self-priming and employ four independent pumping chambers to pump water smoothly and quietly.

SPECIFICATIONS

- Inlet and outlet: 1/2" male BSP threaded
- 30psi shut off
- 24 volt
- multi-fixture
- 1.82m (6 feet) prime



SHURFLO 12V BLASTER PUMP N/S

034384 RETAIL BOX

Perfect for tough wash down applications such as fish box, scaling and anchor chain cleaning.

FEATURES

- Supplied with spray nozzle
- Delivers high lift, can run dry without damage and will not overheat with extended use
- Rugged and self-priming

SPECIFICATIONS

- Flow Rate: 13.2L/min
- Pressure: 45psi



SHURFLO 12V NAUTLUS PUMP 1GPM

005588

Tough, rugged and compact. Designed to deliver 3.7L/min with minimal power consumption. Perfect for low volume, single fixture applications. Protected from thermal overload.

FEATURES

- Tough, rugged and compact
- Requires in-line switch and 3A fuse
- 3/8" barbs
- 2.1A max
- Not self priming



SHURFLO 12V AQUAKING JUNIOR 2GPM

005656

This 2 GPM pump guarantees quiet operation and smooth performance while providing the ultimate in durability and reliability. This 12V DC pump is designed and built for the harsh marine environment and for 1-2 fixture applications.

FEATURES

- Self-priming and sealed switch
- Seamless shell e-coated motor
- Ignition and thermally protected

SPECIFICATIONS

- Dimension: 184mm(l) x 127mm(h) x 118mm(w)
- Flow Rate: 7.6L/min (2.0/gpm)
- Voltage: 12V DC
- Amps: 4A
- Shut-Off Pressure: 30psi



SHURFLO 24V BLASTER WASH PUMP

005604 24V PUMP

Rugged and self-priming. Perfect for tough washdown applications such as fish box, scaling and anchor chain cleaning. Supplied with spray nozzle.

FEATURES

- Ignition protected
- Switches are sealed against water damage
- Delivers high lift, can run dry without damage
- Won't overheat with extended use

SPECIFICATIONS

- Dimension: 203mm(w) x 136mm(l) x 127mm(h)
- Flow Rate: 13.2 L/min
- Voltage: 24V DC -3A
- Pressure: 45psi



SHURFLO BILGE PUMP 500

036770

This pump is built for the harsh marine environment to withstand the toughest conditions.

FEATURES

- Submersible with 3" tinned wire assembly
- Anti-airlock
- Ignition protected

SPECIFICATIONS

- ABS housing with nylon impeller



SHURFLO SWIVEL UNION

005407 1/2BX1/2F

005408 1/2BX1/2F

005410 3/4BX1/2F

Note: these will not give a water tight seal on all BSP threads as they also rely on the internal section making contact with the internal flared SHURflo/Flojet pump thread



SHURFLO PRESSURE ACCUMULATOR N/S

034387

Pre-pressurised to 20psi, cycling pulsation is reduced and pressure spikes up to 125psi increasing the life of the pump and saving battery power.

SPECIFICATIONS

- 1/2" NPTM
- Pressure: 30psi



SHURFLO SWIVEL ELBOW

005404 1/2" FEMALE TO 1/2" BARB

005406 1/2" FEMALE TO 3/4" BARB

Nut and tail to suit 12mm hose. Tighten by hand only.

- Please note, these will not give a water tight seal on all BSP threads as they also rely on the internal section making contact with the internal flared SHURflo/Flojet pump thread



SHURFLO CLASSIC TWIST ON FILTER

005672 1/2" INLET AND OUTLET M-F

034391 1/2" INLET AND 1/2" BARB OUTLET

Fits directly to the inlet of all Classic and Aqua King pumps.

FEATURES

- The transparent design allows for easy visual check while the bowl allows easy cleaning

SPECIFICATIONS:

- 1/2" NPSM Inlet
- Stainless steel mesh



WHALE ONE-WAY IN-LINE VALVE

005785

When fitted in line on the suction side of a pump, Whale non-return valves will ensure maintenance of prime, particularly if pump valves are weak.

SPECIFICATIONS

- Suit 12.5mm ID hose
- Ideal for holding water primed on hand pumps (p.29)



WHALE SUPERSUB 12V PUMP GP1352

035605 SUBMERSIBLE

Suitable for dual purpose manual/electric systems.

FEATURES:

- Does not require priming
- Simple, compact and low cost
- Self venting design eliminates air locking
- Designed to be dropped into a water tank
- Inexpensive way to update from a manual to an electric system

SPECIFICATIONS

- Dimensions: 116mm(l) x 50mm(h) x 50mm(d)
- Weight: 150g
- Output: Up to 12L/M at zero discharge head
- Pumps fresh, saltwater and diesel
- Low power consumption
- Suits 10mm or 12mm (with supplied adaptor)

CODE	PRODUCT NAME
043924	SHURFLO PRESSURE SWITCH
042112	SHURFLO 12V 4009 SWITCH 45 PSI
005674	SHURFLO 2088 DIAPH DRIVE KIT
070035	SHURFLO UPPER HOUSING T/S
042114	SHURFLO 12V 4009 UPPER ASSY 45
042116	SHURFLO 12V 4009 DRIVE ASSY
042117	SHURFLO 12V 4009 CHECK VALVE
005677	SHURFLO 2088 UPPER HOUSING &SW
005641	SHURFLO 2088 MICRO SWITCH
005666	SHURFLO PUMP REPAIR KIT





WHALE 12V PUMP IN LINE

005753

In-line, 12V centrifugal pump, light enough to be suspended in the hose line. Sealed against casual water.

FEATURES

- Simple, compact and low cost
- Boosts pressure in manual or electric pump systems
- Ideal for up to two mixer outlets
- Lightweight, fits unsupported into pipework
- Fits neatly below water tank

SPECIFICATIONS

- Dimensions: 135mm(l) x 38mm(h) x 38mm(d)
- Weight: 150g
- Output: 10L/min
- Hose tails accept 3/8" or 1/2" ID hose
- Low current draw



WHALE SUPERSUB 921 12V PUMP

005751

Suitable for dual purpose manual/electric systems.

FEATURES

- Self venting design eliminates air locking
- Designed to be dropped into a water tank
- Does not require priming
- Simple, compact and low cost
- Inexpensive way to update from a manual to an electric system

SPECIFICATIONS:

- Dimensions: 160mm(l) x 50mm(h) x 50mm(d)
- Weight: 200g
- Flow Rate: 15L/min
- Pumps fresh, saltwater and diesel
- Low power consumption



WHALE TIP TOE SERVICE KIT

005581

Service kit for Whale Tip-Toe foot pump



WHALE 12V PORTABLE PUMP KIT

043259

Handy 12V submersible pump with accessories.

FEATURES:

- Simply drop the pump into your water supply and then plug it in
- Great for filling your caravan fresh water tank from a jerry can when camping
- Great for washing down bikes, surf boards etc
- Robust pump suitable for cold and warm water, diesel, light oils and water-based fluids including most water based pesticides
- Pumps up to 15 litres per minute
- Maximum continuous usage should not exceed 15 minutes

KIT INCLUDES

- Whale supersub pump
- 3.75m clear hose and nozzle
- 3.75m lead for 12V connections to a cigarette lighter
- Battery terminal adaptor



WHALE PRESSURE SWITCH

005754

When fitted inline provides a convenient way to create a pressure system with an electric pump without its own switch.

SPECIFICATIONS

- Current Rating: 10A 12/24V
- Cut Out Pressure: Within range 5-25psi

BATHROOM MODULES



SOAP DISPENSER

042872 SINGLE 400ML
042873 DOUBLE 400ML X 2

400ml dispenser available as an individual unit or double. Backing plate is fixed to the wall with screws (provided) or silicone, etc. and dispensers are removable. For hand soap, dish washing liquid, shampoo and body wash. Use in the caravan bathroom or kitchen. If the button is held in, soap will continue to flow until it is released. Colour is white with clear panels so that you can see when to re-fill.



CHROME 6 PIECE SET

002109

FEATURES

- Set of 6. Includes: soap dish holder, toilet roll holder, towel rail, towel ring, glass tumbler and holder.
- Chrome



SUPER SUCTION

039885 TOILET ROLL HOLD
039888 HOOK 3KG
039889 TOWEL RING
039890 SOAP DISH
039891 BASKET 3 IN 1

Instantly transform a room with an affordable premium suction product. Ideal for homes, motor homes, caravans and offices.

FEATURES

- Super suction
- One step installation
- Removable
- Press button action
- Chrome painted ABS plastic

SPECIFICATIONS

- Weight Load: 3kg



CLEO CABINET WITH SLIDING MIRROR

040836 CABINET
044104 CLEO MIRRORS AND BUTTON

Featuring twin mirror sliding doors complete with a travel lock to ensure the cabinet remains secure whilst on the road. The Cleo vanity cabinet comes with retaining bars as well as a handy accessories shelf.



CLEO BASIN TIP UP

040835

An ideal vanity sink unit for caravan, boat and motor home bathrooms with limited free space. The Cleo tip up sink/folding vanity basin features an integrated soap and toothbrush holder and a simple lift up basin.

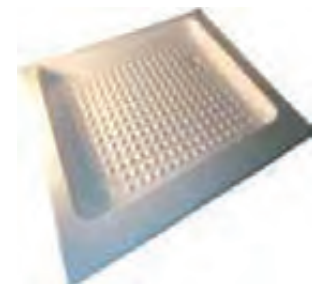

SHOWER TRAY VT90 830X670X55MM

002166

High gloss, ABS, shower tray.

SPECIFICATIONS

- Dimensions: 830mm(l) x 670mm(h) x 55mm(d)
- Made to suit the Thetford Cassette toilet C402 Series.

SINKS & BASINS



BASIN RECTANGULAR 330 X 285MM

043616

Note: The top surface that normally sits above the bench top on these basins is not as smooth as the inner surface of sink/basin - it is not a fault but a function of the manufacturing process.

SPECIFICATIONS

- White
- Use with pop-up waste 043373
- Plug not included
- Dimensions: 330mm(l) x 120mm(h) x 285mm(d)
- Inside Sink Dimensions: 300mm(l) x 120mm(h) x 250mm(d)
- Waste Hole: 40mm (diam)



BASIN ACRYLIC CORNER 279 X 279MM

043617

Acrylic corner basin/sink.

SPECIFICATIONS

- Dimensions: 279mm(l) x 120mm(h) x 279mm(d)
- Inside Sink Dimensions: 280mm(l) x 210mm(w)
- Plug not included
- Waste Hole: 40mm (diam)
- Use with pop-up waste 043373
- White



BASIN RECTANGULAR 508 X 178MM

043618

Acrylic, light and sturdy rectangular basin/sink.

FEATURES

- Sits into a cutout in a bench top or can be attached to wall
- Includes soap drainer
- Space for single tap on either side

SPECIFICATIONS

- Dimensions: 508mm(w) x 130mm(h) x 178mm(d)
- Plug not included
- Waste Hole: 40mm (diam)
- Use with pop-up waste 043373
- White



CAMEC STAINLESS STEEL SINK WITH DRAINER

006046

Top quality stainless steel basin and drainer.

FEATURES

- Foam tape and 8 brackets included
- Does not include plug or waste

SPECIFICATIONS

- Dimensions: 780mm(w) x 170mm(h) x 480mm(d)
- 34mm waste outlet



BASIN SS

038170 315MM X 265MM X 145MM INTERNAL BOWL

038171 327MM X 278MM X 150MM INTERNAL BOWL

038172 352MM X 282MM FULL FLANGE X 155MM

Top quality stainless steel basins available in a number of sizes.

FEATURES

- Lip sits flush on bench top
- Waste hole size 34mm
- Use waste 006072 / 006073 & 006064 plug

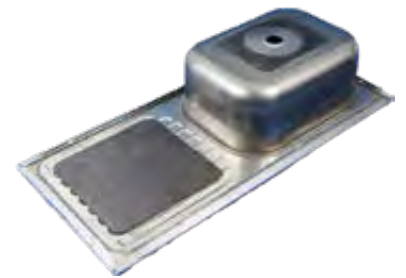

CAMEC STAINLESS STEEL SINK WITH DRAINER

038169

Top quality stainless steel basin and drainer.

FEATURES

- Foam tape and 10 brackets included
- Does not include plug or waste

SPECIFICATIONS

- Dimensions: 760mm(w) x 155mm(h) x 360mm(d)
- 34mm waste outlet



SINK STAINLESS STEEL SINK 780MM X 480MM

042976

Includes waste, plug and mounting clips.

SPECIFICATIONS

- Dimensions: 780mm(w) x 480mm(d) x 170mm(h)
- Dimensions of main sink: 330mm(w) x 380mm(d)
- 90mm waste outlet



CAMEC STAINLESS STEEL ROUND BASIN 450MM

042974

Includes waste, plug and mounting clips.

SPECIFICATIONS

- Dimensions: 450mm(diam.) x 180mm(d)
- 90mm waste outlet



CAMEC STAINLESS STEEL SINK 890MM X 480MM

042973

Includes waste, plug and mounting clips.

SPECIFICATIONS

- Dimensions: 890mm(w) x 480mm(d) x 170mm(h)
- Dimensions of main sink: 315mm(w) x 380mm(d)
- Dimensions of secondary sink: 155mm(w) x 300mm(d)
- 90mm waste outlets



CAMEC STAINLESS STEEL ROUND BASIN & DRAINER

042975

Includes waste, plug and mounting clips.

SPECIFICATIONS

- Dimensions: 850mm(w) x 450mm (d) x 170mm
- Dimensions of sink: 357mm (diam.)
- 90mm waste outlet



BASKET STYLE PLUG FOR SINKS

043358

Replacement basket (strainer) for 90mm sink waste outlets



MINI CORNER BASIN WITH FULL SKIRT

044832 BASIN

FEATURES:

- Useful in shower/toilet combination rooms for space-saving corner design. Neatly hides plumbing behind the skirt
- Does not include mounting screws or a waste outlet
- 45mm waste outlet



WASHBASIN

050945 WHITE

050946 BLACK

SPECIFICATIONS

- White
- Bench top wash basin
- Ceramic
- Weight 5kg
- 48mm waste hole
- No waste included



POP UP WASTE KIT

043373

Suit 40mm waste hole. Pop up sink plug



WASTE KIT FOR 45MM SINK HOLE

042871



PLASTIC WASTE OUTLET 25MM STANDARD

006072

Straight waste suitable for 25mm hose.

FEATURES

- Plug sold separately
- Straight waste
- Suit 34mm hole



PLASTIC 90° WASTE OUTLET 25MM

006073

Suit 34mm hole



RUBBER SINK PLUG

006064 25MM RED

035578 32MM RED

04184 32MM BLACK - SUIT042871 WASTE KIT

TAPWARE



CAMEC HAND PUMP CHROME

043156

Robust chrome plated brass hand pump for drinking water.

FEATURES

- Self priming, dual action
- Easy installation

SPECIFICATIONS

- Height Above Bench: 65mm
- Suits 1/2": tubing
- Chrome plated



BREHA HAND PUMP

005542 BLACK

005543 WHITE

005554 TOP PLUNGER SEAL

005555 BOTT PLUNGER SEAL BLACK

035599 WASHER KIT BS100 & BS101

Self priming and simple to install.

SPECIFICATIONS

- Fits a sink with a 32mm mounting hole



BREHA HAND PUMP SHORT WHITE

005546

Self priming and simple to install.

SPECIFICATIONS

- Fits a sink with a 32mm mounting hole
- White
- Shorter barrel for more clearance under the bench top



HAND PUMP FYNspray

005549

Black moulded nylon body with chrome plated brass handle and swiveling spout. Suitable for fresh or salt water.

SPECIFICATIONS:

- Output: 1L/per 5 strokes



CAMEC BASIN MIXER 110MM FIXED SPOUT

041716 CAMEC BASIN MIXER 110MM FIXED

042792 40MM REPLACEMENT CARTRIDGE

Basin mixer with 110mm fixed spout with a 40mm cartridge.

FEATURES

- WELS rated complies Australian/NZ standard AS/NZS 6400
- Stainless steel braided hoses 350mm length and 1/2" female BSP threads
- 40mm cartridge



CAMEC BASIN MIXER 150MM SPOUT

041674

Basin mixer with 150mm spout with a 40mm cartridge.

FEATURES

- WELS rated complies Australian/NZ standard AS/NZS 6400
- Stainless steel braided hoses 350mm length and 1/2" female BSP threads
- 40mm cartridge
- Able to be swiveled



CAMEC SINK MIXER 220MM SPOUT

041675

Sink mixer with 220mm spout with a 40mm cartridge.

FEATURES

- WELS rated complies Australian/NZ standard AS/NZS 6400
- Stainless steel braided hoses 350mm length and 1/2" female BSP threads
- 40mm cartridge
- Able to be swiveled



VALTERRA CHROME ROCKER HAND PUMP

044831

COLD WATER RV FAUCET: Hand pump is ideal for RV's and campers with a holding tank that require a pump faucet

EASY TO USE: Rotate the handle back and forth to pump water through the faucet

FUNCTIONAL PRIME LOCK: Keep the water in prime hold position for immediate water release, or leave the line in drain position to return water to the holding tank

EASY TO INSTALL: Simply drill a hole through the countertop, place pump, and connect hose to water tank



SHURFLO FAUCET WATER TAP

051291 UNBOXED

005958 RETAIL BOXED

Plastic rotating faucet with built in 12V switch designed for use with a water pump or pressure reducing city water entry.

FEATURES:

- Folds down and is ideal for slide out camper trailer kitchens
- White
- 3/8" hose connection



CAMEC HIGH BASIN MIXER SQUARE

041676

FEATURES

- WELS rated, complies Australian/NZ standard AS/NZS 6400
- Stainless steel braided hoses 350mm length and 1/2" female BSP threads
- 35mm cartridge



CAMEC 3 WAY SINK MIXER

041677 CHROME

042791 35MM REPLACEMENT CARTRIDGE

SPECIFICATIONS

- Top lever controls hot/cold water mixing
- Bottom lever controls separate filtered water line



METAL FOLDING HOT/COLD WATER MIXER TAP SUIT UNDER GLASS SINK

043526

FEATURES

- Solid chrome on brass construction
- Hot/Cold mixer
- Fold down tap
- Low profile to suit the Dometic/Cramer sinks with fold down lid
- Supplied with flexible hoses. Hose input is 1/2 inch male BSP thread

SPECIFICATIONS

- Suits 40mm hole cut out
- Minimum height required above mounting base = 25mm
- 160mm spout from pivot point to end of spout
- 45mm in height from bench/sink top.
- Female 1/2 inch BSP thread on Hot & Cold connectors



BRASS MAINS PRESSURE A FRAME TAP

005975

SPECIFICATIONS

- Vertical face mount brass tap
- Easily mount on A-frame and pipe into existing water supply line



CAMEC 3 WAY SINK MIXER

005954 BLACK

3 way sink mixer incorporates two taps in one - a sink mixer and a filtration faucet. This dual stream has two outlets in the spout and eliminates the need to mount a second faucet for filtered water. Please Note: The tap does not filter water, a separate filtration kit is required.

FEATURES

- WELS rated, complies Australian/NZ standard AS/NZS 6400
- Stainless steel braided hoses 350mm length and 1/2" female BSP threads



WHALE TELESCOPIC FAUCET

005937

Mainly used with foot pumps, the telescopic outlet swivels through 360 degrees and can be pushed down when not in use.

FEATURES

- Great space saver



WHALE TUCKAWAY FAUCET

005938 WITH ON/OFF SWITCH

005939 STANDARD

This faucet fits onto the vertical side of the sink bowl and folds down neatly for storage within the sink. Simply drill a hole into the side of the sink and pass through the thread with rubber seal from the front.

- Rear screws on, providing a two stage hose barb to suit 3/8" or 1/2" hose



HOT/COLD BASIN MIXER

005993

This faucet features hot and cold mixer taps, complete with high rise 200mm swivel spout to allow easy filling of jugs and kettles.

FEATURES

- Chrome on metal finish.
- Model: MG3100
- Supplied with 2 x hot/cold hoses with 3/8 male BSP



MIXER MI2000/1 MINI SGL LEVR

006002

The mixer will fit in a single hole in your bench top or wall. Comes with 3 flexible hoses (200mm long), that connect to the underside of the tap.

FEATURES

- Features solid handle.
- Tap is chrome finish on metal. Has non-drip ceramic discs.

SPECIFICATIONS

- All have 3/8 BSP male thread
- The thickness of mounting can be from 30mm to 0.5mm thick
- Width of top flange section 42mm
- Hole size required in sink or bench 32mm
- Hot water in, cold water hose in, mixed water hose out



HOT/COLD BASIN MIXING FAUCET

005910

Hot and cold mixer set with fold down faucet.

SPECIFICATIONS

- Requires barb to take 12mm hose (005951 x 2)
- Chrome
- 3/8" male BSP male fittings



SINGLE CHROME COLD TAP

005995

Low profile fixed pillar tap.

FEATURES

- Chrome on metal finish



MIXER ART 33 SGL LEVER CHROME

006004

Shower set mixer, suit recessed shower set. This is a mixer only without spout - usually used with a shower hose/rose.

FEATURES

- The mixer will fit in a single hole in your bench top or wall. Comes with 3 flexible hoses (200mm long), that connect to the underside of the tap.

SPECIFICATIONS

- Mixed outlet is Male 3/8 inch BSP thread
- Hot inlet is Male 3/8 inch BSP thread
- Cold inlet is Male 3/8 inch BSP thread
- Suit bench thickness 1mm to 25mm
- Tap covers a hole up to 41mm as is, or if using the included large washer up to 49mm max.
- The mixer thread diameter measures 1 1/4 Inch which is slightly under 32mm. You will need some clearance.



BARWIG SINGLE FAUCET AND SWITCH

005953 BARWIG SINGLE 052 FAUCET & SWITCH

005954 BARWIG SINGLE 052 FAUCET NO SWITCH

SPECIFICATIONS

- Maximum Inlet Pressure: 35psi



TAP DECK WASHDOWN SINK

005996

Single tap with threaded outlet, suit washing machine or where a hose is to be connected.

FEATURES

- Chrome on metal finish



SINGLE FOLD DOWN TAP - R OR L OPTION

005895 RIGHT HAND SIDE OF SINK

005904 LEFT HAND SIDE OF SINK

Requires barb to take 12mm hose (005951)

SPECIFICATIONS

- 3/8" male BSP male fitting



SINGLE FOLDING FAUCET CHROME

005990

Single folding faucet - when folded body is 39mm high.

FEATURES

- Chrome finish



CARTRIDGE T/S L/H & R/H FAUCET

005896

Replacement cartridge to suit fold down chrome taps (005895, 005904, 005910)



CAMEC TAP HANDLE

005899

Suits the fold down mains pressure taps. Includes various spline adapters, brass screw and colour buttons.



BRASS UNION 1/2" BSP X 3/8" FEMALE WITH WASHER

005951

Water, brass adaptor, female 3/8" BSP to 12.5mm barb. Clamp your 12mm hose to one end the other end screws onto a male 3/8" BSP thread.



BLACK KITCHEN MIXER TAP

050950



BLACK KITCHEN MIXER TAP

050951



BLACK KITCHEN MIXER TAP

050952



BLACK PAPER HOLDER

050939



BLACK SHOWER MIXER

050937



BLACK SHOWER MIXER

050938



BLACK SHOWER RAIL

050947



BLACK TALL MIXER TAP

050936



DOUBLE ROBE HOOK

050940



RECESS TRANSOM SHOWER KIT

051129

Flush mounting aft deck swim shower kits includes -

SPECIFICATIONS

- White nylon container with hinged door and catch
- Quality chrome brass hot & cold water mixer tap
- Adjustable flow shower head
- 3 or 5 metre shower hose with chrome fittings
- Concealed fastening holes for a neat finish



RECESS SHOWER HEAD/HOSE W ON/OFF

005856

Hose and rose pulls out externally from underneath cap



CAMEC SHOWER WALL MIXER

041678

Shower wall mixer 40mm cartridge.

FEATURES:

- WELS rated complies Australian/NZ standard
- AS/NZS 6400
- 405mm cartridge



TRIGGER SHOWER SET

005857

This trigger shower set has a heavy duty chrome finish. On/off trigger incorporated in handle. Wall bracket to suit (refer code 005872).

- White



SHOWER HOSE 1.5M

005870

Hose to suit elbow shower set (refer code 005869).

SPECIFICATIONS

- 1/2" female at handpiece end
- 3/8" male at mixer end



SHOWER WITH ADJUSTABLE FLOW RATE/HOSE ELBOW

005869

This elbow shower set comes complete with adjustable flow rate nozzle. Heavy duty construction.

FEATURES

- Heavy duty chrome finish
- Includes adjustable flow rate nozzle
- Wall bracket to suit - refer code 005872

SPECIFICATIONS

- Hose: 1.5m length
- Chrome hose
- White handle



WALL BRACKET

005872

Bracket to suit trigger and elbow shower set.

- Chrome



ON/OFF TRIGGER SHOWER SET

043267

On/off trigger incorporated in handle. Chrome hose 1.5m.

- White/chrome



THROUGH BULKHEAD ELBOW CONNECTOR

005874

This fitting is used to connect hand shower sets where installation is required through wall fixing.

FEATURES

- Heavy duty chrome finish
- This elbow fits the CAMEC shower and trigger shower hose
- 3/8" BSP through wall and outlet suits chrome flexible shower hose, which is also 3/8" BSP
- Chrome



HOT/COLD SHOWER MIXER ONLY CHROME WITH CRYSTAL HANDLES

005861

To suit hand held showers.

- Chrome
- 3/8 MBSP connections



SHOWER MIXER ONLY SOLID HANDLE

005862

- Chrome



CAMEC SHOWER KIT

005860

CAMEC Shower Kit, with mixer, rose, hose & bracket. Heavy duty construction.

FEATURES

- The shower hose connection on the mixer is a swivel type so the taps can be mounted on a vertical or horizontal surface.

SPECIFICATIONS

- Hand held shower rose.
- Adjusting nozzle.
- An adjustable swivel wall bracket to hold shower rose.
- Chrome covered shower hose.
- Hot & cold chrome mixer tap.



BREHA 9100 SHOWER HOSE WHITE

005885



RECESS EXTERNAL WALL SHOWER

005810 SHOWER KIT WHITE

005832 REPLACEMENT HOSE WHITE

042898 SHOWER KIT BLACK

044458 RECESSED WALL SHOWER KEY

Suitable for external recessed wall types, annexes, shower tents, etc. with keyed lock security.

FEATURES

- Fade and impact resistant, UV stabilised and can be painted
- Unit screws into the cut-out from the outside face - screws are covered when door is closed
- Hot and cold pipes connect at the rear to 1/2" BSP male water pipe fitting. Same goes for the shower rose connections
- On/off switch on shower rose
- Shower rose can be either hand held or bracketed to door

SPECIFICATIONS

- Cut-Out Size: 155mm x 280mm (w)
- Can be installed either horizontally or vertically
- Extends outside just 12-15mm
- 120mm from mounting inside to end of threads



**SHOWER BOX WITH HOT COLD MIXER
PULL OUT PUSH BUTTON**

005822

A compact shower with a long hose.

SPECIFICATIONS

- Dimensions: 180mm(l) x 130mm(h) x 325mm(d)
- 4m hose
- White



SHOWER SET WITH SLIDING BAR

005882

Includes double lock flexible hose and soap holder.

SPECIFICATIONS

- Sliding Bar - 690mm length
- Brass double lock
- Flexible hose



SINGLE ROBE HOOK

050941



SINGLE TOWEL RAIL

050943



**HANDHELD SHOWER ROSE AND BRACKET
WHITE**

005833

FILTRATION



B.E.S.T. INLINE WATER FILTER

038332 322H WITH HOSE CONNECTORS
043282 1/2" FBSP NO FITTINGS 322T
044190 NLON BUSH - 3/4" M TO 1/2" BSP FEM

The hose range is a DIY installation - it connects to your drinking water/filling hose in less than a minute. This inline is dual purpose - it can be used on your hose to fill your tanks and also when you are connected directly to mains water.

FEATURES

- Reversible - if the flow reduces, simply reverse the unit, hook it back up and flush the dirt away
- Compact - stores away with your hose
- Sealed - no cartridges
- Replace after approx 5,000 LT



B.E.S.T. INLINE MOUNTING CLIPS

038333

Mounting clips for B.E.S.T. Inline Water Filter (refer code 038332).

SPECIFICATIONS

- Pack of 2



SHURFLO FILTRATION KIT FOR RV AND MARINE

036794 KIT

036795 FILTER CARTRIDGE REPLACEMENT

Designed for both RV and marine applications.

FEATURES

- Supplied complete with all parts and fittings including carbon block disposable filter
- Reduces unpleasant tastes and odours
- Provides fresh, clean drinking water



THIRSTY NOMAD WATER EXT

051538

For the first time in Australia, The Thirsty Nomad brings affordable water purification to the RV sector. Based scientific evidence and the latest in water purification technologies to Australian caravanners, requiring no power and no chemicals.

FEATURES

- 5 Stage water treatment system to purify water
- Removes 10 heavy metals inc. Lead, Fluoride, Arsenic III and Arsenic V
- A Grade NSF Certified, 5 micron Carbon Fibre Block (CFB)
- CFB has up to 20 X higher contaminant removal than granular carbon
- Long lasting at 7,500 litres (pending water quality)
- 99.9% of bacteria blocked from bacterial colonisation of carbon
- 0.01micron Ultrafiltration
- Quantum Disinfection™ kills 99.9999% of bacteria & viruses upon contact
- Meets Australian Drinking Water Guidelines for E-Coli



THIRSTY NOMAD WATER EXT

051539

For the first time in Australia, The Thirsty Nomad brings affordable water purification to the RV sector.

Based scientific evidence and the latest in water purification technologies to Australian caravanners, requiring no power and no chemicals.

FEATURES

- 5 Stage water treatment system to purify water
- Removes 10 heavy metals inc. Lead, Fluoride, Arsenic III and Arsenic V
- A Grade NSF Certified, 5 micron Carbon Fibre Block (CFB)
- CFB has up to 20 X higher contaminant removal than granular carbon
- Long lasting at 7,500 litres (pending water quality)
- 99.9% of bacteria blocked from bacterial colonisation of carbon
- 0.01micron Ultrafiltration
- Quantum Disinfection™ kills 99.9999% of bacteria & viruses upon contact
- Meets Australian Drinking Water Guidelines for E-Coli



AQUATAB WATER TABLETS 50-BOX

000263

Effervescent water purification tablets. When dissolved in one litre of water, renders water suitable for drinking after just thirty minutes.

FEATURES

- Fast acting and fast dissolving

SPECIFICATIONS

- Pack of 50
- 1 tablet/1 litre water



CLEANOXIDE WATER TREATMENT

043283

FEATURES

- Controls bacteria, fungi, viruses, biofilm and algae
- Neutralises unpleasant taste and odours from the tank
- Effective over a wide pH range (4 to 10)
- Biodegrades in sunlight, so no harmful effects on the environment if flushing your tank
- Active ingredient was approved in Australia for the treatment of drinking water in 2005
- Each tablet treats 100 to 400 litres of water
- Zip-lock pouch with full instructions on the back
- Contains 8 x 4g tablets



WHALE AQUA SOURCE WATER FILTER

026528

An inline water filter to be fitted in the cold water pipe.

FEATURES

- Very efficient
- When fitted, filter will remove foreign bodies and dirt particles, nasty tastes and smells
- Disposable
- 4,500LT lifespan

GAS COMPLIANCE & SAFETY



GAS DETECTOR 12V MTG 3000H

043896

The MTG-3000H Gas Alarm is intended to detect leakage of bottled gas. It is intended for installation in caravans and boats. The alarm is connected to a power source of 12V DC (non polarised) when used in caravans or boats, or connected to the mains through an external transformer (Not included) 240V AC/12V DC

FEATURES

- While a 240v-12v transformer is provided, it does not have an Australian plug - you will need to remove the transformer plug to wire into your 12V system.
- Connecting to your 12v system will provide power.

SPECIFICATIONS

- Measures a small 75 x 75 x 35mm



LP GAS STORAGE STICKER

042544

Red and White LP Gas Storage Sticker



LPG CONSUMER INSTRUCTION PLATE (CARAVAN)

003869

Metal gas instruction plate with consumer instructions for fixing to caravans

SPECIFICATIONS

- Dimensions: 100mm(l) x 100mm(h) x 1mm(d) large plate
- Pack of 2 different pieces
- Small plate 100 x 45 x 1mm



DECAL GAS VENTILATION

043380

White with black writing.

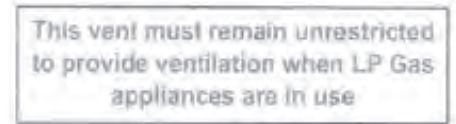

DECAL GAS VENT UNRESTRICTED

043381

White with black writing.



GAS PRESSURE TEST POINT 5/16" FLARE

003909

This test point is located immediately downstream from the regulator. It allows the user to easily test that gas is coming through the regulator and that it is at reduced pressure.

SPECIFICATIONS

- 5/16" SAE Male x 3/8" BSPT Male
- Inlet: 3/8" - screws into regulator
- Outlet: 5/16" SAE Male flare



GAS DETECTOR SAFE-T-ALERT 12V

000342

Gas detector Safe-T-Alert 12V suitable for LPG and natural gas.

FEATURES

- Draws 46 MA and is simple to operate
- When the test switch is activated a complete diagnostic test is performed
- The detector is fully operational from 6 to 16V DC, providing continuous operation
- Required 12V permanent connection



GAS COMPLIANCE DECAL

003875 NO:3 - NEAR STOVE

003877 NO:5 - BOOT LID

003878 NO:6 - EVACUATION

Consumer instructions for fixing to caravans/marine craft.



GAS TEST POINT 3/8" FLARE

003910

This test point is located immediately downstream from the regulator. It allows the user to easily test that gas is coming through the regulator and that it is at reduced pressure.

SPECIFICATIONS

- 3/8" SAE Male x 3/8" BSPT Male
- Inlet: 3/8" - screws into regulator
- Outlet: 3/8" SAE Male flare

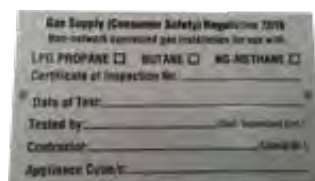

LP GAS COMPLIANCE PLATE NSW

003871 95MM X 55MM

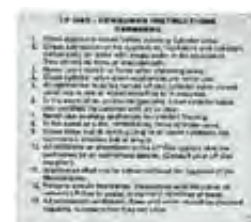

LPG INSTRUCTION PLATE

051498

GAS COPPER PIPE & FASTENERS



COPPER TUBE

003950 1/4" 30M ROLL
003952 5/16" 30M ROLL
003954 3/8" 18M ROLL

Annealed copper tube suitable for gas installations.



SADDLE

003959 SADDLE COPPER 5/16" - 7.95MM TUBE
003960 SADDLE COPPER 3/8" - 9.52MM TUBE
003961 SADDLE COPPER 1/2" - 12.7MM TUBE
PLASTIC
042642 13MM SADDLE CLAMP
042656 19MM SADDLE CLAMP



YELLOW THREAD SEAL GAS TAPE

004063

Used on threaded joins on gas pipe.

- Yellow
- 12mm
- 10m

GAS FITTINGS & ADAPTORS



ADAPTOR 3/8LH F-TO 1/4BSP MALE
051461



ADAPTOR 3/8LH MALE TO 1/4BSP F
051462



ADAPTOR 9KG BOT-TO 3/8LH COMP
051464



ADAPTOR MALE POL TO 1/4 BSP M
051463



GF5 ADAPTOR GAS FITTING
050044

GF5 adaptor gas fitting adaptor 1/4 BSPF x 3/8 male SAE for BBQ and ring burners.



GF12 ADAPTOR GAS FITTING QUICK CONNECT
050045

Quick action connect 3/8 SAEF x 3/8 SAEM QC80



N06 FLARE NUT SAE

- 003967 N06 FLARE NUT 5/16 SAE FEMALE
- 003968 N06 FLARE NUT 3/8 SAE FEMALE
- 003973 N06R RED FLARE NUT 3/8 X 5/16 TUBE
- 003974 N06R RED FLARE NUT 1/2 X 3/8 TUBE



N07 UNION SAE TO BSP

- 003976 1/4 X 3/8 MALE SAE & MALE BSP
- 003977 5/16 X 1/8 MALE SAE & MALE BSP
- 003978 5/16 X 1/4 MALE SAE & MALE BSP
- 003979 5/16 X 3/8 MALE SAE & MALE BSP
- 003980 5/16 X 1/2 MALE SAE & MALE BSP
- 003981 3/8 X 1/8 MALE SAE & MALE BSP
- 003982 3/8 X 1/4 MALE SAE & MALE BSP
- 003983 3/8 X 3/8 MALE SAE & MALE BSP
- 003984 3/8 X 1/2 MALE SAE & MALE BSP



N08 ELBOW

- 003989 5/16 MALE SAE X 1/4 MALE BSP
- 003990 5/16 MALE SAE X 3/8 MALE BSP
- 003992 3/8 MALE SAE X 1/4 MALE BSP



N016 FEMALE UNION

- 003995 1/4 MALE SAE X 1/4 FEMALE BSP
- 003997 5/16 MALE SAE X 1/4 FEMALE BSP
- 003998 5/16 MALE SAE X 3/8 FEMALE BSP
- 004000 3/8 MALE SAE X 1/4 FEMALE BSP
- 004001 3/8 MALE SAE X 3/8 FEMALE BSP
- 004002 3/8 MALE SAE X 1/2 FEMALE BSP
- 004003 1/2 MALE SAE X 3/8 FEMALE BSP



N017 DOUBLE UNION

- 004004 1/4 MALE SAE X 1/4 MALE SAE
- 004005 5/16 MALE SAE X 5/16 MALE SAE
- 004006 3/8 MALE SAE X 3/8 MALE SAE
- 004007 5/16 MALE SAE X 1/4 MALE SAE
- 004008 3/8 MALE SAE X 5/16 MALE SAE



N018 DOUBLE ELBOW

- 004010 5/16 MALE SAE X 5/16 MALE SAE
- 004011 3/8 MALE SAE X 3/8 MALE SAE



N019 3-WAY TEE

- 004013 5/16 SAE
- 004014 3/8 SAE



N024 REDUCING BUSH

- 036529 3/8 MALE BSP X 1/4 FEMALE BSP
- 036530 1/2 MALE BSP X 1/4 FEMALE BSP
- 036531 1/2 MALE BSP X 3/8 FEMALE BSP



N025 EXTRUDED ELBOW

- 004018 1/4 MALE BSP X 1/4 FEMALE BSP
- 036532 3/8 MALE BSP X 3/8 FEMALE BSP



N027 HEXAGON NIPPLE 1/4" X 1/4"

004020 1/4" MALE BSP X 1/4" MALE BSP



N036 FEM UNION ELBOW

004028 3/8 MALE SAE X 3/8 FEMALE BSP



N038 SINGLE UNION BODY

036542 5/16 MALE BSP X 1/8 MALE BSP
036543 5/16 MALE BSP X 1/4 MALE BSP
036544 5/16 MALE BSP X 3/8 MALE BSP

N038 SINGLE UNION BODY

036546 5/16" MALE BSP X 3/8" FEMALE BSP



N039 DOUBLE UNION BODY

036547 5/16" X 5/16"



N056 FLARE CAP NUT

004029 5/16" FEMALE FLARE SAE
004030 3/8" FEMALE FLARE SAE



**N062 - 1/4" MALE BSP X 1/4" FEMALE
INVERTED FLARE UNION**

004033

Used to convert copper pigtailed with dual/changeover regulators. For use with single OPP regulators less POL.

SPECIFICATIONS

- Female Union 1/4" Male BSPT Inverted Flare 1/4"



N065 FLARE PLUG

004035 5/16" MALE FLARE SAE
004036 3/8" MALE FLARE SAE



N070 FLARE SWIVEL CONNECT

004037 5/16" FEMALE SAE X 5/16" FEMALE SAE
004038 3/8" FEMALE SAE X 3/8" FEMALE SAE



N072 ADAPTOR

036553 3/8" FEMALE BSP X 1/4" MALE BSP
036554 1/2" FEMALE BSP X 1/4" MALE BSP
036555 1/2" FEMALE BSP X 3/8" MALE BSP



N073 REDUCING NIPPLE

036556 1/4" MALE BSP X 1/8" MALE BSP
004041 3/8" MALE BSP X 1/4" MALE BSP



BALL VALVE

004043 1/4FBSP X 1/4FBSP
004046 5/16 SAE & NUTS
004047 3/8 BSP & NUTS
004048 3/8 SAE NO NUTS



FEMALE 3/8" LEFT HAND THREAD X FEMALE POL

004054 ATTACH TO 3/8" L/H CYLINDER TO TAKE P.O.L FITTINGS
004059 ELBOW FEMALE 3/8" LH TO FEMALE P.O.L



ELBOW 3/8" LEFT HAND THREAD

004056 3/8" MBSP X POL MALE LH R ANGLE

Attaches to P.O.L (9kg) type cylinder to take 3/8" L/H fittings.



GAS ADAPTOR 1/2" MALE BSP X 5/16" SAE MALE FLARE

042580

Commonly used to attach 5/16" copper pipe to gas bayonet (004051)



GAS BAYONET FLOOR MOUNT CHROME 1/2" FEMALE BSP

004051

To suit low pressure appliances such as barbeques and flueless space heaters. For floor or wall mount.

FEATURES

- Chrome plated
- Dust cap
- Mounting screws x 2

SPECIFICATIONS

- Connection: 1/2" female
- Maximum Inlet Pressure: 7kPa
- Chrome



MALE BAYONET FITTING

033800

Low pressure appliance hose adaptor.

FEATURES

- Brass
- Bayonet to 1/4" male BSP



GAS BAYONET DUST CAP

043382

Keeps your gas bayonet socket clean and free of dirt and insects.



O RING ADAPTOR GAS FITTING

050347

Replacement O-ring for P.O.L fittings.

GAS CYLINDERS & PRODUCTS



GAS CYLINDERS

- 003856 1.25KG 3/8 L/H THREAD
- 003857 2KG 3/8 L/H THREAD
- 051294 GAS CYL 4KG C/W POL-SQUAT LCC27 VALVE
- 051570 GAS CYL 4.5KG C/W POL-TALL TYPE 27 VALVE
- 051569 GAS CYL 9KG POL NO GAUGE CAMEC TYPE 27 VALVE

SPECIFICATIONS

- Diameter 260mm
 - Overall Height 348mm
 - Water Capacity 9.6Kg
 - Tare Weight 5.5Kg (approx.)
 - Finish Powder coated (Class 2)
 - Test Pressure 3.3MPa
 - Valve SCG POL with sullage
- Valve outlet POL 0.885" -14NGO-LH-INT (CGA510)



CYLINDER FRONT OPENING CRADLE

- 050030 SMALL SUIT 4KG CYLINDERS
- 050031 LARGE SUIT 9KG CYLINDERS

Brackets included to enable welding



GAS CYLINDER CRADLE, EXTRA STRONG BASE

- 003829 9KG WITH ADJUSTABLE CLASP
- 039073 4KG WITH ADJUSTABLE CLASP

Brackets included to enable welding

GAS HOSES



BAYONET HOSE 3/8" SAE FEMALE X MALE BAYONET

051257 1500MM
051258 3000MM

SPECIFICATIONS

- Class A low pressure appliance
- Suit Weber Q BBQ
- This has a SAE female thread



BARFLEX HOSE 3/8" BSP FF X MALE BAYONET

035693 1M
035694 2M

SPECIFICATIONS

- Commonly used on gas room meters
- Class A low pressure appliance
- NB: this has a BSP female thread



GAS HOSE 1200 BRAID X 5/16" MALE 003932

SPECIFICATIONS

- Class C high pressure appliance
- Maximum Working Pressure: 2600kPa
- Working Temperature Range: -20°C to +65°C
- 5/16" male SAE fittings at each end



GAS BAYONET HOSE

002913 2.0M BAYONET X 1/4" BSPF
002914 1.5M BAYONET X 1/4" BSPF
002920 1.2M BAYONET X 1/4" BSPF

SPECIFICATIONS

- Class B low pressure/high temperature appliance
- Maximum Working Pressure: 14 kPa
- Working Temperature Range: -20°C to +125°C



GAS HOSE STAINLESS STEEL SUIT DOUBLE CYLINDER WITH HAND WHEEL

003902

SPECIFICATIONS

- 450mm x 7/16" inverted flare with hand wheel
- Class C
- Maximum Working Pressure: 2600kPa
- Working Temperature Range: -20°C to +65°C
- Used to attach cylinder to changeover manifold (043464)
- With hand wheel for hand tight fitting
- Suits twin cylinder



PIGTAIL - TYPE 27 - CLASS F

051792 6MM S/S PIGTAIL LCC27 CLASS F 7/16 -24 I/F 450MM
051793 6MM S/S PIGTAIL LCC27 CLASS F 7/16 -24 I/F 600MM
051794 6MM S/S PIGTAIL LCC27 CLASS F 1/4" NPT M 450MM
051795 6MM S/S PIGTAIL LCC27 CLASS F 1/4" NPT M 600MM



PIGTAIL COPPER POL TO CHANGEOVER REGULATOR

003897 762MM (30")
036517 460MM (18")

SPECIFICATIONS

- Not suitable for single cylinder installations
- POL x 7/16" inverted flare suits most applications
- Class C
- Maximum Working Pressure: 2600kPa
- Used to attach cylinder to a change over regulator
- Suits twin cylinder setup

GAS HOSE PVC

003944 600MM 1/4" F INV FLARE BSP X 1/4" F INV FLARE BSP
036508 2400MM 1/4" F INV FLARE BSP X 1/4" F INV FLARE BSP
036509 1800MM 1/4" F INV FLARE BSP X 1/4" F INV FLARE BSP
036510 900MM 3/8" MALE BSP X 1/4" F BSP INV FLARE
036512 300MM 1/4" F INV FLARE BSP X 1/4" F INV FLARE BSP
003919 1800MM 3/8" MALE BSP X 3/8" F FLARE SAE
003920 600MM 3/8" F FLARE SAE X 3/8" F FLARE SAE
003924 1200MM 3/8" F FLARE SAE X 3/8" F FLARE SAE
003935 1200MM 3/8" MALE BSP X 1/4" F BSP INV FLARE

003911 300MM 3/8" MALE FLARE SAE X 3/8" MALE BSP
003912 450MM 3/8" MALE FLARE SAE X 3/8" MALE BSP
003913 600MM 3/8" MALE FLARE SAE X 3/8" MALE BSP
003927 300MM 5/16" MALE FLARE SAE X 3/8" MALE BSP
003928 450MM 5/16" MALE FLARE SAE X 3/8" MALE BSP
003929 600MM 5/16" MALE FLARE SAE X 3/8" MALE BSP
003930 600MM 5/16" F FLARE SAE X 5/16" F FLARE SAE
003931 1200MM 5/16" F FLARE SAE X 5/16" F FLARE SAE
003937 1500MM 3/8" MALE BSP X 1/4" F BSP INV FLARE
044957 90MM 3/8" MALE BSP X 5/16" F FLARE SAE

SPECIFICATIONS

- Class C high pressure appliance
- For use with LPG (propane)
- 6mm hose diameter



GAS REGULATORS

A fixed regulator should always be installed in an upright position and the outlet of the regulator to be located higher than the valve on the cylinder.

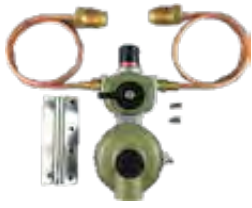

AUTO CHANGEOVER REGULATOR

050557

SPECIFICATIONS

- Inlet Pressure: 100psi
- Two stage automatic changeover regulator complete with copper pig tails, mounting bracket and screws
- Automatically changes from one empty tank to another full tank for a limited time to allow lever to be manually pointed to the full cylinder



MARSHALL SINGLE REGULATOR

042050 190MJ 195,000 BTU/HR

042051 290MJ GREEN TOP 285,00 BTU/HR

This two stage regulator combines both a high pressure first stage and a low pressure second stage regulator into a single unit. Ideal for RV applications to ensure a smooth and continuous flow.

SPECIFICATIONS

- Inlet Pressure: 100psi
- Outlet Pressure: 11" W.C
- Inlet: 1/4" NPT FEM



BRACKET - MARSHALL SGL REG/OPP

003886

Bracket Suit Marshall Single O.P.P.Reg. Metal bracket around 100mm long



GAS REGULATOR SINGLE-STRAIGHT POL

036523 SPARE SOFT NOSE CONE

Straight adjustable soft nose regulator. Not for RV use

SPECIFICATIONS

- Capacity: 175mj/hr - 3.5kg/hr
- Inlet: POL
- Outlet: 3/8" NPT



SINGLE REGULATOR WITH OVER PRESSURE PROTECTION NO POL

036520

Non adjustable regulator for RV installations only.

FEATURES

- Includes 1/4" inverted flare adaptor, bracket and fixing screws

SPECIFICATIONS

- Capacity: 160mj/hr - 3.2kg/hr
- Inlet: 1/4" NPT
- Outlet: 3/8" NPT



GAS REGULATOR OPP MANUAL DUAL AND BRACKET

003892

Non adjustable regulator for RV installations only.

FEATURES

- Dual stage
- Complete with bracket and fixing screws

SPECIFICATIONS

- Manual changeover
- Capacity: 160mj/hr - 3.2kg/hr
- Inlet: 7/16" FNPT x2
- Outlet: 3/8" NPT



CARAVAN, MOTORHOME 2 STAGE GAS REGULATOR AND BRACKET

051644

Dual Stage Gas Regulator, complete with mounting bracket and fixing screws.

Adjustable Regulator for Caravan's, Campervan's, Motorhome's & RV Installations Only.

SPECIFICATIONS

- Flow Rate: 280 Mj/hr
- Pressure: Inlet 1750 kpa Outlet 2.75 kpa
- For added safety there is a built in pressure relief device, which is set to 4.2 KPA
- 1/4" BSP Female Inlet.
- 3/8" BSP Female Outlet.
- Adjustment range 9 - 13" WC
- Length: 144mm
- Width: 84mm
- Height: 76mm
- Easily switch between cylinders. Replacement manifold for twin cylinder regulator set ups.



MANUAL CHANGEOVER GAS VALVE

043464

Easily switch between cylinders. Replacement manifold for twin cylinder regulator set ups.



WINDOWS

Odyssey Windows	225
Odyssey Plus Windows	228
Odyssey Premium Windows	231
Jupiter Windows	233
Sash Frames	236
Odyssey Fly Screens	238
Slimline Slider & Wind Out Window Parts .	239
Viento Blinds	243

ODYSSEY WINDOWS



ODYSSEY 2 AND 4 RADIUS CORNER SINGLE AND DOUBLE HOPPER WINDOWS

The Odyssey window range is a wind out style window with a fixed fly screen. This fly screen can be removed and cleaned as required. The Odyssey window is available with a tinted, single glazed acrylic panel in a black or white frame.

Available in multiple sizes, as a:

- Standard 2 radius corner single hopper
- 2 radius corner double hopper
- 4 radius corner single hopper with 2 panels

FEATURES

- Single or double opening window (size dependent)
- Odyssey style single glazed acrylic panel and UV stabilised
- Top hinge opening to various opening widths (open to an angle of 70 degrees max)
- Smooth aluminum extrusion in a black or white frame
- The single winder can be placed at either end with gearing to ensure mechanism cannot be overwound
- Removable and replaceable press on fly screens
- * Fitted with single winder box on L/H side (inside looking out)

PART NO.	DESCRIPTION	SIZE (H X W)	COLOUR
041313	*ODYSSEY 2RCSH	280 X 457	BLACK
041314	*ODYSSEY 2RCSH	280 X 457	WHITE
051327	ODYSSEY 2RCSH	280 X 457	BLACK
051328	ODYSSEY 2RCSH	280 X 457	WHITE
041317	ODYSSEY 2RCSH	280 X 762	BLACK
041318	ODYSSEY 2RCSH	280 X 762	WHITE
041319	ODYSSEY 2RCSH	280 X 914	BLACK
041320	ODYSSEY 2RCSH	280 X 914	WHITE
041321	ODYSSEY 2RCSH	280 X 1175	BLACK
041322	ODYSSEY 2RCSH	280 X 1175	WHITE
041323	ODYSSEY 2RCSH	380 X 457	BLACK
041324	ODYSSEY 2RCSH	380 X 457	WHITE
041325	ODYSSEY 2RCSH	380 X 610	BLACK
041326	ODYSSEY 2RCSH	380 X 610	WHITE
041327	ODYSSEY 2RCSH	380 X 762	BLACK
041328	ODYSSEY 2RCSH	380 X 762	WHITE
041329	ODYSSEY 2RCSH	380 X 914	BLACK
041330	ODYSSEY 2RCSH	380 X 914	WHITE
041331	ODYSSEY 2RCSH	380 X 1175	BLACK
042400	ODYSSEY FIXED 2RC	380 X 1175	BLACK
041332	ODYSSEY 2RCSH	380 X 1175	WHITE
041333	ODYSSEY 2RCSH	380 X 1524	BLACK
041334	ODYSSEY 2RCSH	380 X 1524	WHITE
038458	2RC FIX WINDOW	450 X 1175	WHITE
041335	ODYSSEY 2RCSH	508 X 457	BLACK
041336	ODYSSEY 2RCSH	508 X 457	WHITE
041337	ODYSSEY 2RCSH	508 X 762	BLACK
041338	ODYSSEY 2RCSH	508 X 762	WHITE
041339	ODYSSEY 2RCSH	508 X 914	BLACK
041340	ODYSSEY 2RCSH	508 X 914	WHITE
041341	ODYSSEY 2RCSH	508 X 1175	BLACK

041342	ODYSSEY 2RCSH	508 X 1175	WHITE
041343	ODYSSEY 2RCSH	508 X 1524	BLACK
041344	ODYSSEY 2RCSH	508 X 1524	WHITE
041345	ODYSSEY 2RCSH	565 X 457	BLACK
041346	ODYSSEY 2RCSH	565 X 457	WHITE
041347	ODYSSEY 2RCSH	565 X 610	BLACK
041349	ODYSSEY 2RCSH	565 X 762	BLACK
041350	ODYSSEY 2RCSH	565 X 762	WHITE
041351	ODYSSEY 2RCSH	565 X 914	BLACK
041352	ODYSSEY 2RCSH	565 X 914	WHITE
041353	ODYSSEY 2RCSH	565 X 1175	BLACK
041354	ODYSSEY 2RCSH	565 X 1175	WHITE
041355	ODYSSEY 2RCSH	565 X 1524	BLACK
041356	ODYSSEY 2RCSH	565 X 1524	WHITE
051322	ODYSSEY 4 RC POW WINDOW FRAME	813 X 762	BLACK
041360	ODYSSEY 4RCSH 2P 4LCK	903 X 914	WHITE
042057	ODYSSEY 4RCSH 2P 4LCK	903 X 914	BLACK

DOUBLE HOPPER

PART NO.	DESCRIPTION	SIZE (H X W)	COLOUR
041357	ODYSSEY 2RCDH	951 X 914	BLACK
041358	ODYSSEY 2RCDH	951 X 914	WHITE
041361	ODYSSEY 2RCDH	1137 X 914	BLACK
041362	ODYSSEY 2RCDH	1137 X 914	WHITE

ODYSSEY WINDOW EXPLODED VIEW

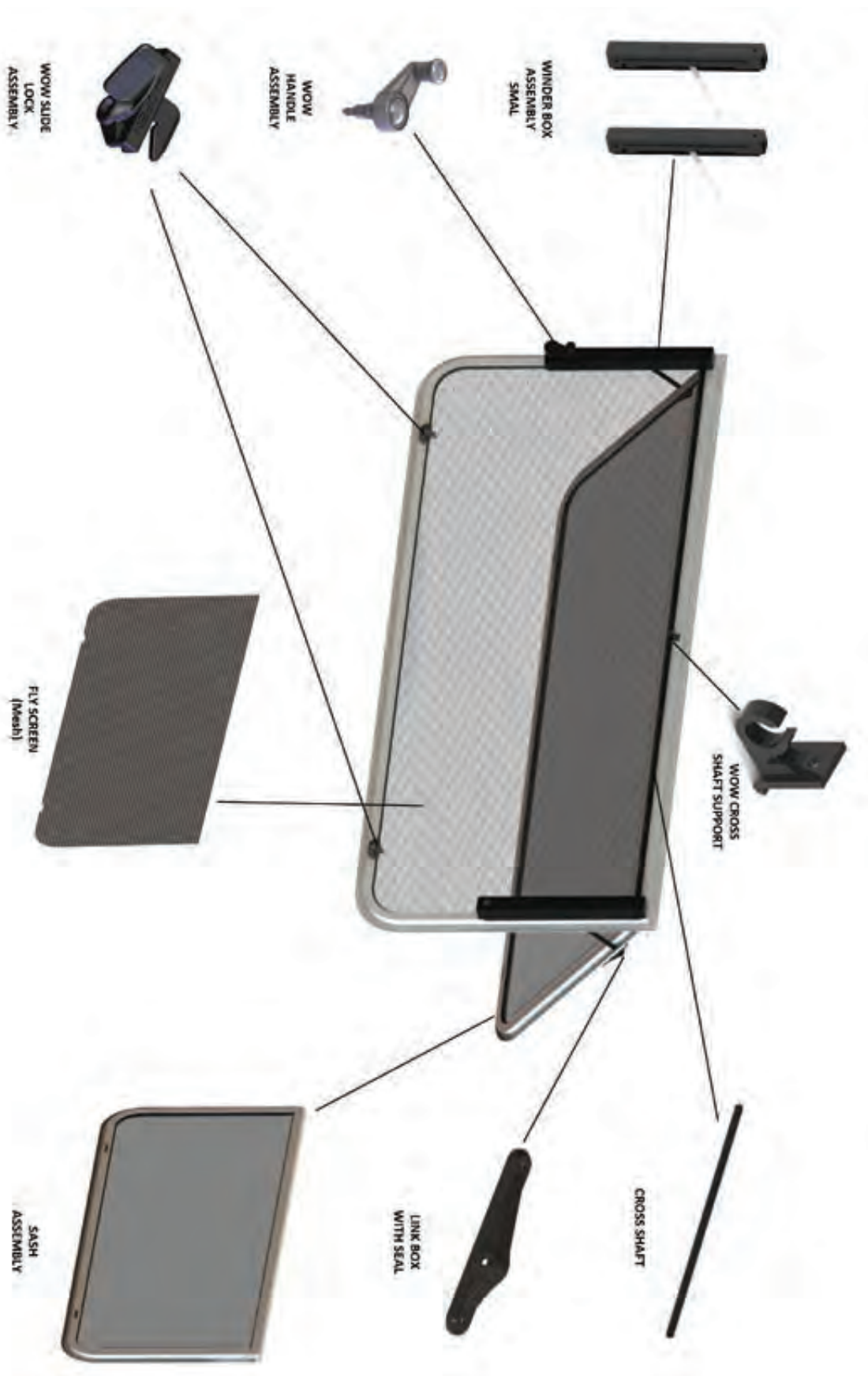

FITTING INSTRUCTIONS FOR ODYSSEY WIND OUT WINDOWS

1. All cut outs to be -0/+2mm larger than the normal size on ALL windows.
Example: 565 x 762 Odyssey 2RCSH (also applicable to 4RCSH) Window requires cut out size of 565 to 567 high x 762 to 764 wide, with a 70mm radius cut in each lower corner.
2. Cut outs to be square and parallel within 1-2mm.

WIDTH = 762mm
762mm to 764mm



HEIGHT = 565mm
565mm to 567mm

RADIUS =
70mm

1. Check the prepared opening is square and has been cut to the nominated size.
Clean dust and dirt from around the opening where the window is going to be fitted. Wipe window main frame flange with a dry cloth to remove dust.



2. Apply foam tape all the way around the mainframe flange. Top corner of the window is a suitable starting point. Take particular care around the 2 radius corner. Cut off tape end at the starting point to form a continuous seal. Join foam tape, cleanly, as above. Apply bead of silicone to foam tape.

- For bedding compound use:
1. Butyl Rubber Tape
 2. Double sided or one sided foam tape
 3. 100% silicone rubber sealant.
 4. A suitable combination of the above. MUST BE A FLEXIBLE ADHESIVE



3. Fill cladding seams with silicone then crush final 10mm. Position window in opening of the van where it is going to be permanently installed. Do this from the outside of the van. Bottom of the window to go in first - to clear thumb locks.



4. With the bottom of the window in place, gently push the top of the window in position in the opening. Insert screws into pre-drilled holes in main frame, DO NOT tighten screws until all screws have been inserted and window is in position. Once in position, fully tighten all screws in opposite sequence until all screws have been secured.
5. Unlock the thumb locks to the left
6. Insert handle fully into control box (left or right as required. A press plug is provided to blank off handle hole in control box not fitted with handle.
7. Wind clockwise until window is open.
8. Direct pressure on the window may be necessary to release the window from the packing blocks.
9. Remove packaging blocks from the window frame and discard.
10. REMOVE PLASTIC PACKING BLOCKS AND INSTALL WINDER HANDLE IN THE MOST CONVENIENT SIDE OF WINDOWS.
When installing on front of the caravan protector shade with drip mould must be used. Camec recommends installation of angles 20 degrees or less.
11. Close window checking sash alignment with window almost closed. It may be necessary to adjust as detailed below, particularly if the window frame is mounted on other than a flat plane

Example:
To prepare opening for window 565mm x 762mm

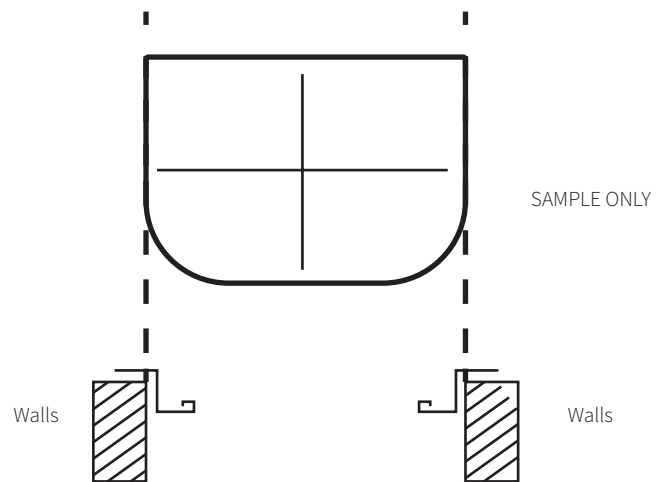

NOTE: Adjustment of blade alignment

- A. Sash & Frame - Disengage cross shaft by pushing shaft into R/H box against the spring to release left end from the L/H box. Turn handle to align blade parallel to frame measured with window almost closed. Replace rod and check.
- B. Double Hopper - 2 handles, individual control - adjust each sash and frame in instruction A.

ODYSSEY PLUS WINDOWS



ODYSSEY PLUS 4 RADIUS CORNER WINDOWS

The Camec Odyssey Plus is a wind out window with push-in fly screen, 4 radius corner design with a one piece, UV stabilised, acrylic window.

Supplied with curved winder boxes that contour with the window design. Available in a wide range of sizes, in black or white main frames, with clamp ring installation that suits 27mm or 29mm wall thicknesses.

FEATURES

- The Odyssey single glazed acrylic panel can be used in both caravans and motor homes
- Internal clamp ring included for specified 27mm or 29mm wall thicknesses. Internal locking catches without opening fly screen
- 4 radius corner design
- Single winder handle can be placed at either end with gearing to ensure mechanism cannot be overwound

SUIT WALL THICKNESS 27MM

PART NO.	DESCRIPTION	SIZE (H X W)	COLOUR
041255	ODYSSEY PLUS	380 X 457	BLACK
041256	ODYSSEY PLUS	380 X 457	WHITE
041257	ODYSSEY PLUS	380 X 914	BLACK
041258	ODYSSEY PLUS	380 X 914	WHITE
041259	ODYSSEY PLUS	380 X 1175	BLACK
041261	ODYSSEY PLUS	380 X 1524	BLACK
041263	ODYSSEY PLUS	450 X 610	BLACK
041264	ODYSSEY PLUS	450 X 610	WHITE
041265	ODYSSEY PLUS	450 X 762	BLACK
041266	ODYSSEY PLUS	450 X 762	WHITE
041267	ODYSSEY PLUS	450 X 914	BLACK
041268	ODYSSEY PLUS	450 X 914	WHITE
041269	ODYSSEY PLUS	450 X 1175	BLACK
041270	ODYSSEY PLUS	450 X 1175	WHITE
041271	ODYSSEY PLUS	565 X 610	BLACK
041272	ODYSSEY PLUS	565 X 610	WHITE
041273	ODYSSEY PLUS	565 X 762	BLACK
041274	ODYSSEY PLUS	565 X 762	WHITE
041277	ODYSSEY PLUS	565 X 1175	BLACK
041278	ODYSSEY PLUS	565 X 1175	WHITE
041279	ODYSSEY PLUS	565 X 1524	BLACK
041280	ODYSSEY PLUS	565 X 1524	WHITE
041282	ODYSSEY PLUS	665 X 1175	WHITE
041283	ODYSSEY PLUS	737 X 914	BLACK
041284	ODYSSEY PLUS	737 X 914	WHITE
041285	ODYSSEY PLUS	737 X 1175	BLACK
041286	ODYSSEY PLUS	737 X 1175	WHITE
041290	ODYSSEY PLUS 4LCK	903 X 914	WHITE
042055	ODYSSEY PLUS 4LCK	903 X 914	BLACK

SUIT WALL THICKNESS 29MM

PART NO.	DESCRIPTION	SIZE (H X W)	COLOUR
041292	ODYSSEY PLUS	380 X 457	BLACK
041293	ODYSSEY PLUS	380 X 457	WHITE
041294	ODYSSEY PLUS	380 X 914	BLACK
041296	ODYSSEY PLUS	450 X 610	BLACK
041299	ODYSSEY PLUS	450 X 914	BLACK
041300	ODYSSEY PLUS	450 X 1175	BLACK
041301	ODYSSEY PLUS	565 X 610	BLACK
041302	ODYSSEY PLUS	565 X 762	BLACK
041303	ODYSSEY PLUS	565 X 762	WHITE
041304	ODYSSEY PLUS	565 X 914	BLACK
041306	ODYSSEY PLUS	565 X 1175	BLACK
041307	ODYSSEY PLUS	565 X 1175	WHITE
041308	ODYSSEY PLUS	565 X 1524	BLACK
041309	ODYSSEY PLUS	565 X 1524	WHITE
041310	ODYSSEY PLUS	737 X 914	BLACK
041687	ODYSSEY PLUS	903 X 914	BLACK

ODYSSEY PLUS WINDOW EXPLODED VIEW

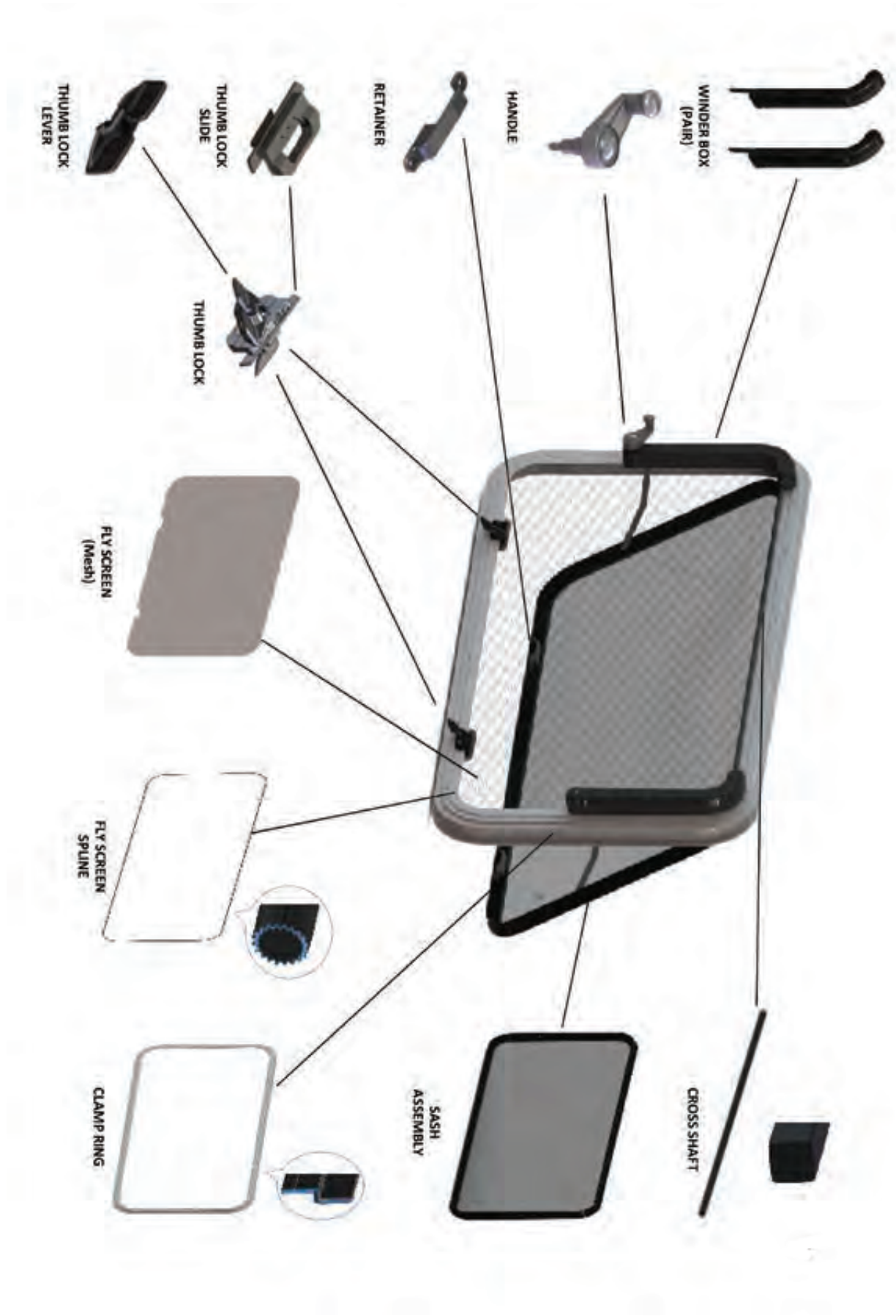

ODYSSEY PLUS / SLIMLINE SLIDER CLAMP RING INSTALLATION

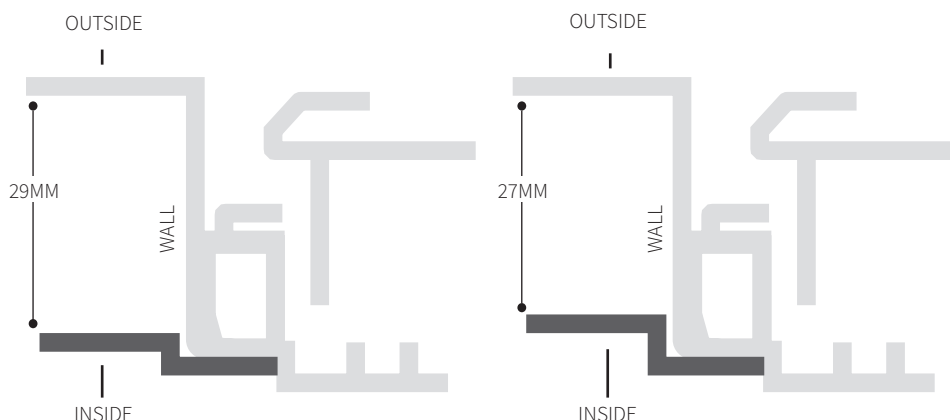

NORMAL

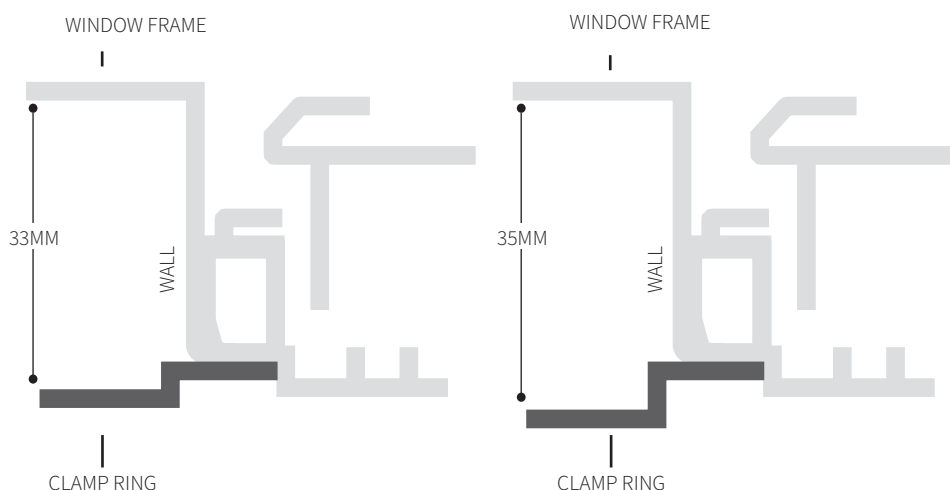

REVERSED

4 RADIUS CORNER CLAMP RINGS

4 radius corner clamp ring to suit Camec Slimline and Odyssey plus windows thickness of wall listed first

10.5MM OR 15MM CLAMP RING

PART NO.	DESCRIPTION	COLOUR	SUIT WINDOW SIZE
011851	4RC SLIM CLAMP	BLACK	565 X 762
011855	4RC SLIM CLAMP	BLACK	565 X 1175

22MM CLAMP RING

PART NO.	DESCRIPTION	COLOUR	SUIT WINDOW SIZE
011838	4RC SLIM SLIDER CLAMP	BLACK	280 X 762

26MM CLAMP RING

PART NO.	DESCRIPTION	COLOUR	SUIT WINDOW SIZE
050009	4RC S/L SLDR 26MM	BLACK	565 X 914

29MM CLAMP RING

PART NO.	DESCRIPTION	COLOUR	SUIT WINDOW SIZE
011681	4RC SLIM CLAMP 29MM	WHITE	380 X 1175

33MM CLAMP RING

PART NO.	DESCRIPTION	COLOUR	SUIT WINDOW SIZE
011836	4RC SLIM SLIDER CLAMP	BLACK	565 X 1175

ODYSSEY PREMIUM WINDOWS



WINDOW WITH 27MM BLIND CLIP

PART NO.	DESCRIPTION	BLIND INCLUDED	SIZE (H X W)	COLOUR
041621	ODYSSEY PREMIUM	NO	380 X 457	BLACK
041625	ODYSSEY PREMIUM	NO	380 X 914	BLACK
041614	ODYSSEY PREMIUM	NO	380 X 1175	BLACK
040476	ODYSSEY PREMIUM	NO	380 X 1175	BLACK
041632	ODYSSEY PREMIUM	NO	450 X 610	BLACK
041636	ODYSSEY PREMIUM	NO	450 X 762	BLACK
041640	ODYSSEY PREMIUM	NO	450 X 914	BLACK
041628	ODYSSEY PREMIUM	NO	450 X 1175	BLACK
041655	ODYSSEY PREMIUM	NO	565 X 762	BLACK
041644	ODYSSEY PREMIUM	NO	565 X 1175	BLACK
041648	ODYSSEY PREMIUM	NO	565 X 1524	BLACK
041649	ODYSSEY PREMIUM	NO	565 X 1524	BLACK
041663	ODYSSEY PREMIUM	NO	903 X 914	BLACK

ODYSSEY PREMIUM 4 RADIUS CORNER WINDOWS

The Camec Odyssey Premium window features an Odyssey acrylic panel in a double glazed form, with handle and locks with 3 positions - lock, open and ventilation. The separate blind and fly screen are housed in a stylish frame. With easy to use window stays that allow for multiple opening widths. The 4 radius corner push out design can be easily used as replacement for a Camec Odyssey Plus or Slimline window.

Designed for 27mm and 29mm wall thickness.

FEATURES

- The Odyssey double glazed acrylic panel can be used in both caravans and motor homes
- Aluminium window and blind clips included for specified 27mm or 29mm wall thickness
- 4 radius corner design on all windows
- 3 stage push button lock - open, ventilation and closed
- Push-out windows catch at pre-set distances and release with further push

SPECIFICATIONS

- Double glazed, UV stabilised, tinted acrylic panel
- Frame Colour: black or white
- Wall Thickness: 27mm or 29mm (using blind clips)

WINDOW WITH 29MM BLIND CLIP

PART NO.	DESCRIPTION	BLIND INCLUDED	SIZE (H X W)	COLOUR
041622	ODYSSEY PREMIUM	NO	380 X 457	BLACK
044017	ODYSSEY PREMIUM FIXED		380 X 1175	BLACK
041689	ODYSSEY PREMIUM	YES	380 X 1175	WHITE
041641	ODYSSEY PREMIUM	NO	450 X 914	BLACK
041645	ODYSSEY PREMIUM	NO	565 X 1175	BLACK
041647	ODYSSEY PREMIUM	NO	565 X 1175	WHITE
042611	ODYSSEY PREMIUM	NO	903 X 914	BLACK
042612	ODYSSEY PREMIUM	NO	903 X 914	WHITE

ODYSSEY PREMIUM WINDOW BLIND II

Blind/flyscreen to suit Camec Odyssey premium windows. Attaches to window installation clips.

PART NO.	DESCRIPTION	SUIT WINDOW SIZE
043288	ODYSSEY PREM BLIND II	380 X 457
050309	ODYSSEY PREM BLIND II	380 X 457
050310	ODYSSEY PREM BLIND II	380 X 914
050306	ODYSSEY PREM BLIND II	380 X 1175
043291	ODYSSEY PREM BLIND II	450 X 762
050311	ODYSSEY PREM BLIND II	450 X 1175
050314	ODYSSEY PREM BLIND II	565 X 762
050313	ODYSSEY PREM BLIND II	565 X 1175
050318	ODYSSEY PREM BLIND II	565 X 1524
050315	ODYSSEY PREM BLIND II	903 X 914



ODYSSEY PREMIUM EXPLODED VIEW



JUPITER WINDOWS



JUPITER 2 RADIUS SINGLE HOPPER WIND OUT WINDOWS

FEATURES

- Manufactured for Australian conditions
- Lightweight and glazed with UV stabilised tinted acrylic
- Wind out operation
- Easy face fix installation
- Removable fly screens
- Old style acrylic insert - limited sizes available.

PART NO.	DESCRIPTION	SIZE (H X W)	COLOUR
037708	JUPITER 2RCSH	450 X 762	BLACK
037716	JUPITER 2RCSH	450 X 1175	BLACK
037718	JUPITER 2RCSH	450 X 1175	WHITE

JUPITER 4 RADIUS SINGLE HOPPER WIND OUT WINDOWS

PART NO.	DESCRIPTION	SIZE	COLOUR
037766	JUPITER 4RCSH	813 X 1175	BLACK
038945	JUPITER 4RCSH	813 X 1524	BLACK
037769	JUPITER 4RCSH	903 X 914	BLACK

REPLACEMENT ACRYLIC PANEL ONLY (NO FRAME)

PART NO.	DESCRIPTION	SIZE
022967	JUPITER PANEL NO 4J	243 X 877
022992	JUPITER PANEL NO 55J	302 X 894



GLASS WINDOWS

PART NO.	DESCRIPTION	SIZE (H X W)	COLOUR
037173	CAMEC 2RCSH	280 X 457	WHITE
037248	CAMEC 2RCSH	280 X 1524	WHITE
039403	CAMEC 2RCSH	450 X 914	BLACK
040195	2RC FIXED WINDOWS-C/TSG*	565 X 762	WHITE
037508	CAMEC 2RCSH	565 X 1175	WHITE
037573	CAMEC 2RC DH	737 X 1524	WHITE

* Clear toughened safety glass

CAMEC SLIMLINE WINDOWS

PART NO.	DESCRIPTION	SIZE (H X W)	COLOUR	SUIT WALL THICKNESS
011982	CAMEC 4RC SLIMLINE	737 X 914	WHITE	27MM 6 LOCK
040381	CAMEC 4RC SLIMLINE	1028 X 914	BLACK	22MM 6 LOCK
040383	CAMEC 4RC SLIMLINE	1028 X 914	BLACK	27MM 6 LOCK
040382	CAMEC 4RC SLIMLINE	1028 X 914	WHITE	22MM 6 LOCK
040384	CAMEC 4RC SLIMLINE	1028 X 914	WHITE	27MM 6 LOCK



CAMEC SLIMLINE SLIDER

The CAMEC Slimline Slider range offers a two panel window, one panel sliding to allow for exceptional ventilation, with one panel fixed in position. The slider comes with a fixed fly screen, clamp ring for easy installation and can be used on a wide variety of wall sizes.

WITH 26MM CLAMP RING

PART NO.	DESCRIPTION	SIZE (H X W)	FRAME COLOUR	POSITION
038113	CAMEC S/LINE SLDR	280 X 457	BLACK	RH
038117	CAMEC S/LINE SLDR	280 X 457	BLACK	LH
038115	CAMEC S/LINE SLDR	280 X 457	WHITE	RH
038119	CAMEC S/LINE SLDR	280 X 457	WHITE	LH
034636	CAMEC S/LINE SLDR	280 X 762	BLACK	RH
034670	CAMEC S/LINE SLDR	280 X 762	BLACK	LH
034638	CAMEC S/LINE SLDR	280 X 762	WHITE	RH
034672	CAMEC S/LINE SLDR	280 X 762	WHITE	LH
034643	CAMEC S/LINE SLDR	280 X 1175	WHITE	RH
034677	CAMEC S/LINE SLDR	280 X 1175	WHITE	LH
034648	CAMEC S/LINE SLDR	450 X 762	BLACK	RH
034684	CAMEC S/LINE SLDR	450 X 762	WHITE	LH
038515	CAMEC S/LINE SLDR	450 X 1175	BLACK	LH
038570	CAMEC S/LINE SLDR	508 X 914	BLACK	RH
038571	CAMEC S/LINE SLDR	508 X 914	BLACK	LH
038328	CAMEC S/LINE SLDR	565 X 762	WHITE	RH
034660	CAMEC S/LINE SLDR	565 X 1175	BLACK	RH
034694	CAMEC S/LINE SLDR	565 X 1175	BLACK	LH
034663	CAMEC S/LINE SLDR	565 X 1175	WHITE	RH

WITH 33MM CLAMP RING

PART NO.	DESCRIPTION	SIZE (H X W)	FRAME COLOUR	POSITION
035941	CAMEC S/LINE SLDR	280 X 762	BLACK	RH
035940	CAMEC S/LINE SLDR	280 X 762	BLACK	LH

TINTED TOUGHENED SAFETY GLASS SLIDERS WITH MIDGE FLY SCREEN*

PART NO.	DESCRIPTION	SIZE (H X W)	FRAME COLOUR	POSITION
035101	S/LINE SLD MIDGE	280 X 762	BLACK	RH
035094	S/LINE SLD MIDGE	280 X 762	BLACK	LH
035095	S/LINE SLD MIDGE	565 X 762	BLACK	LH
035102	S/LINE SLD MIDGE	565 X 1175	BLACK	RH

* Not supplied with clamp ring. See page 15

RIGHT HAND = Kerb side. Fixed glass at front. Slides right to left (as viewed from outside)

LEFT HAND = Drivers side. Fixed glass at front. Slides left to right (as viewed from outside)



CAMEC 2 RADIUS CORNER MK2 SHADES

Suits all 2RC glass and acrylic windows. Features a formed acrylic panel with black or white powder coat frame and specially designed stays with in-built limit stops which allow full and easy adjustment. Full length waterproof hinge for ease of installation to the 2RC windows. White infill panel unless specified.

PART NO.	DESCRIPTION	FRAME COLOUR	SIZE (H X W)
039190	CAMEC 2RC MK2 SHADE	BLACK	290 X 1226
035915	CAMEC 2RC MK2 SHADE	WHITE	290 X 1226
035916	CAMEC 2RC MK2 SHADE	WHITE	290 X 1575
039191	CAMEC 2RC MK2 SHADE	BLACK	390 X 508
038475	CAMEC 2RC MK2 SHADE	BLACK	390 X 965
035918	CAMEC 2RC MK2 SHADE	WHITE	390 X 965
035919	CAMEC 2RC MK2 SHADE	BLACK	390 X 1226
039404***	CAMEC 2RC MK2 SHADE	BLACK	390 X 1226
042534*	CAMEC 2RC MK2 SHADE	BLACK	390 X 1226
035921	CAMEC 2RC MK2 SHADE	WHITE	390 X 1226
035922	CAMEC 2RC MK2 SHADE	BLACK	390 X 1575
035923	CAMEC 2RC MK2 SHADE	WHITE	390 X 1575
035924	CAMEC 2RC MK2 SHADE	BLACK	460 X 661
041724**	CAMEC 2RC MK2 SHADE	BLACK	460 X 661
035926	CAMEC 2RC MK2 SHADE	WHITE	460 X 661
035927	CAMEC 2RC MK2 SHADE	BLACK	460 X 1226
041934*	CAMEC 2RC MK2 SHADE	BLACK	460 X 1226
043371***	CAMEC 2RC MK2 SHADE	BLACK	460 X 1226
042917****	CAMEC 2RC MK2 SHADE	BLACK	460 X 1226
035930	CAMEC 2RC MK2 SHADE	WHITE	460 X 1226
035931	CAMEC 2RC MK2 SHADE	BLACK	460 X 1575
035932	CAMEC 2RC MK2 SHADE	WHITE	460 X 1575
039168	CAMEC 2RC MK2 SHADE	BLACK	518 X 508
041075****	CAMEC 2RC MK2 SHADE	BLACK	518 X 1226
035934	CAMEC 2RC MK2 SHADE	BLACK	518 X 1226

042326*	CAMEC 2RC MK2 SHADE	BLACK	518 X 1226
043596****	CAMEC 2RC SHADE NOVA	BLACK	518 X 1226
044069°	CAMEC 2RC MK2 SHADE	BLACK	518 X 1226
050367	CAMEC 2RC MK2 SHADE	BLACK	518 X 1226
035935	CAMEC 2RC MK2 SHADE	WHITE	518 X 1226
035936	CAMEC 2RC MK2 SHADE	BLACK	518 X 1575
044070°	CAMEC 2RC MK2 SHADE	BLACK	518 X 1575
035937	CAMEC 2RC MK2 SHADE	WHITE	518 X 1575
044197	CAMEC 2RC MK2 SHADE	WHITE	518 X 2000
038304	CAMEC 2RC MK2 SHADE	BLACK	575 X 1226
042535*	CAMEC 2RC MK2 SHADE	BLACK	575 X 1226
040936***	CAMEC 2RC MK2 SHADE	BLACK	575 X 1226
035938	CAMEC 2RC MK2 SHADE	WHITE	575 X 1226
038356	CAMEC 2RC MK2 SHADE	BLACK	575 X 1575
043597°	CAMEC 2RC MK2 SHADE	BLACK	575 X 1575
035939	CAMEC 2RC MK2 SHADE	WHITE	575 X 1575
043450	CAMEC 2RC SHADE SMW	WHITE	575 X 1575
042916****	CAMEC 2RC MK2 SHADE	BLACK	575 X 1575
041517*	CAMEC 2RC MK2 SHADE	BLACK	575 X 1575
041516*	CAMEC 2RC MK2 SHADE	BLACK	575 X 1575
050528°°	CAMEC 2RC MK2 SHADE	BLACK	575 X 1575
039455	CAMEC 2RC SHADE	WHITE	575 X 2083
050380*	CAMEC 2RC MK2 SHADE	BLACK	625 X 1575
050381	CAMEC 2RC MK2 SHADE	WHITE	625 X 1575
070032	CAMEC 2RC SHADE	WHITE	645 X 1681
050987****	MK2 SHADE PANEL	BLACK	625 X 1576

- * Cristal silver infill
- ** Diamond silver infill
- *** Polished grey infill
- **** Jet black infill
- ***** Nova light grey infill
- ° Onyx white AL infill
- °° Stucco white infill

SASH FRAMES



ODYSSEY SASH ONLY

To suit 2 radius corner single hopper window.

PART NO.	DESCRIPTION	SIZE (H X W)	FRAME COLOUR
042118	ODYSSEY SASH ASSY	280 X 457	BLACK
042121	ODYSSEY SASH ASSY	280 X 762	BLACK
042131	ODYSSEY SASH ASSY	380 X 762	BLACK
042133	ODYSSEY SASH ASSY	380 X 914	BLACK
042135	ODYSSEY SASH ASSY	380 X 1175	BLACK
042145	ODYSSEY SASH ASSY	508 X 1175	BLACK
042150	ODYSSEY SASH ASSY	565 X 610	BLACK
042152	ODYSSEY SASH ASSY	565 X 762	BLACK
042153	ODYSSEY SASH ASSY	565 X 762	WHITE
042154	ODYSSEY SASH ASSY	565 X 914	BLACK
042155	ODYSSEY SASH ASSY	565 X 914	WHITE
042156	ODYSSEY SASH ASSY	565 X 1175	BLACK
042157	ODYSSEY SASH ASSY	565 X 1175	WHITE



ODYSSEY PLUS 4 RADIUS CORNER SASH ONLY (BLACK FRAME ONLY)

To suit 4 radius corner single hopper window.

PART NO.	DESCRIPTION	SIZE (H X W)
042238	ODYSSEY PLUS SASH ASSY	380 X 457
042242	ODYSSEY PLUS SASH ASSY	380 X 1175
042252	ODYSSEY PLUS SASH ASSY	450 X 1175
042258	ODYSSEY PLUS SASH ASSY	565 X 914
042260	ODYSSEY PLUS SASH ASSY	565 X 1175
042264	ODYSSEY PLUS SASH ASSY	737 X 914
042370	ODYSSEY PLUS SASH ASSY	903 X 914

ODYSSEY PREMIUM 4 RADIUS CORNER SASH ONLY (BLACK FRAME ONLY)

To suit 4 radius corner single hopper window.

PART NO.	DESCRIPTION	SIZE (H X W)
044017	ODYSSEY PREMIUM FIXED	380 X 1175
041950	ODYSSEY PREM SASH ASSY	380 X 457
041949	ODYSSEY PREM SASH ASSY	380 X 914
042446	ODYSSEY PREM SASH ASSY	380 X 1175
042447	ODYSSEY PREM SASH ASSY	380 X 1524
042451	ODYSSEY PREM SASH ASSY	450 X 1175
042453	ODYSSEY PREM SASH ASSY	565 X 762
042454	ODYSSEY PREM SASH ASSY	565 X 914
044248	ODYSSEY PREM SASH ASSY	813 X 762
042458	ODYSSEY PREM SASH ASSY	903 X 914



ODYSSEY PREMIUM WINDOW SPARE PARTS

PART NO.	DESCRIPTION	SIZE
040762	ODYSSEY PREMIUM LOCKING CATCH	WITH STRIKER
042405	ODYSSEY PREM BLIND CLIP	27MM EACH
043722	ODYSSEY PREM BLIND CLIP	29MM EACH
042236	BLACK ODY PREM SCREW M4X10	BOX OF 200
051518	ODYSSEY PREM BULB WINDOW SEAL	
050060	ODYSSEY PREMIUM WINDOW SEAL	4.5M LONG



WINDOW STAYS FOR ODYSSEY PREMIUM WINDOWS

PART NO.	DESCRIPTION	SUIT WINDOW SIZE	POSITION
040673	STAY T/S ODYSSEY PREMIUM	380MM H	LH
040674	STAY T/S ODYSSEY PREMIUM	380MM H	RH
040675	STAY T/S ODYSSEY PREMIUM	450MM H	LH
040676	STAY T/S ODYSSEY PREMIUM	450MM H	RH
040677	STAY T/S ODYSSEY PREMIUM	565MM H	LH
040678	STAY T/S ODYSSEY PREMIUM	565MM H	RH
040679	STAY T/S ODYSSEY PREMIUM	903MM H	LH
040680	STAY T/S ODYSSEY PREMIUM	903MM H	RH



CAMEC JUPITER 2 RADIUS CORNER SASH ONLY

To suit 2 radius corner single hopper window.

PART NO.	DESCRIPTION	FRAME COLOUR	SUIT WINDOW SIZE
042181	JUPITER SASH ONLY	BLACK	280 X 457
042186	JUPITER SASH ONLY	WHITE	280 X 762
042187	JUPITER SASH ONLY	BLACK	280 X 914
042188	JUPITER SASH ONLY	WHITE	280 X 914
042189	JUPITER SASH ONLY	BLACK	280 X 1175
042190	JUPITER SASH ONLY	WHITE	280 X 1175
042193	JUPITER SASH ONLY	BLACK	380 X 610
042195	JUPITER SASH ONLY	BLACK	380 X 762
042196	JUPITER SASH ONLY	WHITE	380 X 762
042197	JUPITER SASH ONLY	BLACK	380 X 914
042198	JUPITER SASH ONLY	WHITE	380 X 914
042199	JUPITER SASH ONLY	BLACK	380 X 1175
042200	JUPITER SASH ONLY	WHITE	380 X 1175
042203	JUPITER SASH ONLY	BLACK	450 X 610
042205	JUPITER SASH ONLY	BLACK	450 X 762
042206	JUPITER SASH ONLY	WHITE	450 X 762
042207	JUPITER SASH ONLY	BLACK	450 X 914
042208	JUPITER SASH ONLY	WHITE	450 X 914
042209	JUPITER SASH ONLY	BLACK	450 X 1175
042210	JUPITER SASH ONLY	WHITE	450 X 1175
042211	JUPITER SASH ONLY	BLACK	450 X 1524
042212	JUPITER SASH ONLY	WHITE	450 X 1524
042215	JUPITER SASH ONLY	BLACK	508 X 762
042216	JUPITER SASH ONLY	WHITE	508 X 762
042217	JUPITER SASH ONLY	BLACK	508 X 914
042218	JUPITER SASH ONLY	WHITE	508 X 914
042219	JUPITER SASH ONLY	BLACK	508 X 1175
042220	JUPITER SASH ONLY	WHITE	508 X 1175
042226	JUPITER SASH ONLY	BLACK	565 X 762
042227	JUPITER SASH ONLY	WHITE	565 X 762
039202**	JUPITER 2RCSH SASH ONLY BLK	BLACK	565 X 914
039500*	JUPITER 2RCSH SASH ONLY WH	WHITE	565 X 914
042230	JUPITER SASH ONLY	BLACK	565 X 1175
042231	JUPITER SASH ONLY	WHITE	565 X 1175
042232	JUPITER SASH ONLY	BLACK	565 X 1524
042233	JUPITER SASH ONLY	WHITE	565 X 1524

* Suits 565 x 914mm window or lower section of 903 x 914mm window - white frame

** Suits 565 x 914mm window or lower section of 903 x 914mm window - black frame

ODYSSEY FLY SCREENS

NB: Size listed is to suit window cut out size. Actual measurements of fly screen is 20mm less.
Eg. 010235 fly screen suits window 280 x 762. Actual fly screen measures 260 x 742mm.



ROUND BOTTOM CORNER

Insect screens for Camec wind-out windows are removable and fully flexible.

Note: The top screen of all double hopper windows has square bottom corners. All single hopper windows and the lower screens of double hopper windows, have round bottom corners. Suits Odyssey and Jupiter windows.

PART NO.	DESCRIPTION	SUIT WINDOW SIZE
010229	FLY SCREEN	280 X 457
010233	FLY SCREEN	280 X 610
010235	FLY SCREEN	280 X 762
010237	FLY SCREEN	280 X 914
010239	FLY SCREEN	280 X 1175
010241	FLY SCREEN	280 X 1524
010231	FLY SCREEN	380 X 457
010243	FLY SCREEN	380 X 610
010245	FLY SCREEN	380 X 762
010247	FLY SCREEN	380 X 914
010249	FLY SCREEN	380 X 1175
010251	FLY SCREEN	380 X 1524
010253	FLY SCREEN	450 X 610
010255	FLY SCREEN	450 X 762
010257	FLY SCREEN	450 X 914
010259	FLY SCREEN	450 X 1175
010261	FLY SCREEN	450 X 1524
010265	FLY SCREEN	508 X 457
010267	FLY SCREEN	508 X 762
010269	FLY SCREEN	508 X 914
010271	FLY SCREEN	508 X 1175
010273	FLY SCREEN	508 X 1524
010263	FLY SCREEN	512 X 762
010275	FLY SCREEN	565 X 457
010277	FLY SCREEN	565 X 610
010279	FLY SCREEN	565 X 762
010281	FLY SCREEN	565X914
010283	FLY SCREEN	565 X 1175
010285	FLY SCREEN	565 X 1524

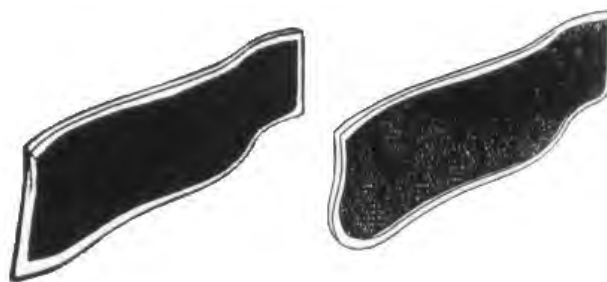

SQUARE BOTTOM CORNER

PART NO.	DESCRIPTION	SUIT WINDOW SIZE
010288	FLY SCREEN	280 X 457
010290	FLY SCREEN	280 X 762
010292	FLY SCREEN	280 X 914
010294	FLY SCREEN	280 X 1175
010296	FLY SCREEN	280 X 1524
010299	FLY SCREEN	512 X 762
010303	FLY SCREEN	565 X 914
010305	FLY SCREEN	565 X 1175



MIDGE SCREEN

Replacement screen with midge proof material insert. Suits Odyssey and Jupiter windows.

PART NO.	DESCRIPTION	SUIT WINDOW SIZE
010230	RD BOT CNR	280 X 457
010234	RD BOT CNRS	280 X 610
010236	RD BOT CNR	280 X 762
010293	SQ BOT CNR	280 X 914
010240	RD BOT CNRS	280 X 1175
010242	RD BOT CNRS	280 X 1524
010246	RD BOT CNR	380 X 762
010250	RD BOT CNRS	380 X 1175
010252	RD BOT CNRS	380 X 1524
010258	RD BOT CNR	450 X 914
010262	RD BOT CNRS	450 X 1524
010280	RD BOT CNR	565 X 762
010282	RD BOT CNR	565 X 914
010304	SQ BOT CNR	565 X 914
010272	RD BOT CNRS	508 X 1175
010284	RD BOT CNRS	565 X 1175
010286	RD BOT CNRS	565 X 1524

SLIMLINE SLIDER AND WIND OUT WINDOW SPARE PARTS



SLIMLINE LOCK KIT

040643

4 locks - 6 retainers



SLIMLINE WINDOW SEAL

040664

Sold per metre



SLIMLINE WINDER BOXES- PAIR

010179

Curved window boxes to suit slimline and odyssey plus windows



SLIMLINE THUMB LOCK LEVER

010181

Suit slimline wind out windows



SLIMLINE MK2 RETAINER

010182

Thumb lock slide retainer - suit slimline wind out windows



SLIMLINE THUMB LOCK SLIDE

010184

Suit slimline wind out windows



CAMEC SLIMLINE SLIDER LOCK KIT

038430

Lock kit for sliding window. (1 x slide, 1 x retainer, 3 x rivets, 1 x catch) Complete window requires 2 kits.



CAMEC SLIMLINE WIND OUT WINDOW LOCK KIT

039280

Lock kit for slimline wind out window. 2 lock sets per kit



SLIMLINE SLIDER SLIP COAT SEAL

039460

Seals the sliding section of the window when closed



SLIM/SLIDER FLY SCREEN SPLINE

018030

3mm foam type spline to suit the slimline wind out and sliding, as well as odyssey plus and premium windows

FEATURES

- Sold per metre
- Fly screen not included



CAMEC SLIMLINE SASH ASSEMBLY

4 radius corner MK2 sash assembly to suit Slimline windows.

PART NO.	DESCRIPTION	SUIT WINDOW SIZE
040037	SLIM/L MK2 SASH ASSEM	380 X 457
018300	SLIM/L MK2 SASH ASSEM	380 X 914
018301	SLIM/L MK2 SASH ASSEM	380 X 1175
018303	SLIM/L MK2 SASH ASSEM	450 X 610
018304	SLIM/L MK2 SASH ASSEM	450 X 762
018305	SLIM/L MK2 SASH ASSEM	450 X 914
018306	SLIM/L MK2 SASH ASSEM	450 X 1175
018309	SLIM/L MK2 SASH ASSEM	565 X 610
018311	SLIM/L MK2 SASH ASSEM	565 X 914
018312	SLIM/L MK2 SASH ASSEM	565 X 1175
018313	SLIM/L MK2 SASH ASSEM	565 X 1524
040023	SLIM/L MK2 SASH ASSEM	665 X 1175
018314	SLIM/L MK2 SASH ASSEM	737 X 914
039780	SLIM/L MK2 SASH ASSEM	737 X 1175
018315	SLIM/L MK2 SASH ASSEM 2 LOCKS	1028 X 914
040120	SLIM/L MK2 SASH ASSEM 4 LOCKS	1028 X 914

SLIMLINE SLIDER & WIND OUT WINDOW SPARE PARTS



SHADE HOLD DOWN CATCH 2 PIECE

016417

External catch that holds the window protector shade down



SHADE STAY

- 016419 250MM
- 016420 200MM
- 016421 100MM



MK2 P/SHADE HEAD NO GROOVE WHITE

039405

Top section of protector shade - aluminium only. Sold per length 5.06m



NEW P/SHADE HEAD PLAIN

- 039904 BLACK 1575MM
- 039342 WHITE 1575MM

Sold per metre

SHADE DRIP MOULD

The drip mould on the Camec protector shade serves the purpose of catching rain water coming from the top section of the RV and dispersing it away from the front window. Enables the fitting of a shade over 4RC window.



PART NO.	COLOUR	SIZE
016401	BLACK	1251 MM
016402	WHITE	1251 MM
039697	WHITE	1524 MM
016403	BLACK	1600 MM
016408	WHITE	1600 MM
016409	BLACK	2500 MM
016412	WHITE	2500 MM



MOULDED PANEL WHITE ACRYLIC REPLACEMENT

PART NO.	DESCRIPTION	SIZE
039393	CAMEC MK2 SHADE PANEL	360X1543
038876	CAMEC MK2 SHADE PANEL	430X1194
039029	CAMEC MK2 SHADE PANEL	488X1194



LOCK CATCH T/S ODY CAMPER DR

044359

Catch section only



WIND OUT WINDOW WEATHER SEAL SANTOPRENE

010219

Also known as 'dust seal' Seals sash section of wind out window when closed

FEATURES

- Sold per metre
- 50m rolls

CAMEC MK2 SHADE PANELS

Moulded Panel

ALUMINIUM FLAT PANEL ONLY

PART NO.	DESCRIPTION	SIZE
020049	PANEL ALI POLAR GREY	360 X 1194
020449	PANEL ALI SMWHITE	545 X 1194
020454	PANEL ALI SMWHITE	545 X 1543



WIND OUT WINDOW GLAZE

- 010220 WEDGE-3MM GLASS
- 010221 WEDGE - 5MM GLASS

FEATURES

- Per metre
- 150m rolls



CNR BRKT STAKE METAL WIND OUT WINDOW

015599



FLY SCREEN SPLINE 6MM

015665



SCREW 6G X5/16 PAN X/R S/T/KB

016749



MESH 610MM F/GLASS CHARCOAL

021533

FEATURES

- Fibreglass fly screen mesh 610mm wide
- Sold per metre



MILLARD WIND OUT WINDOW BULB RUBBER PER M

008548

Suit older Millard windows



MILLARD WIND OUT WINDOW GLAZE-WDG PER M

008549

Glazing Rubber Suit wind out windows, specifically MILLARD and YORK. Price is per metre. This rubber was used on genuine early Millard/York wind out windows with 2 or three louvres.

FEATURES

- Per metre
- 100m rolls



MILLARD WIND OUT WINDOW WEATHER SEAL

008550

Wind out Window Weatherstrip suit Millard. Leg is about 27mm long and section that slips into window is about 5mm high.

SPECIFICATIONS

- 2.06m length
- Commonly used on multi louvred windows



MILLARD/ALFAB POW GLAZE-WEDGE

008552

Glazing Rubber Early Millard, & ALFAB windows. Designed to retain 3mm glass with the ALFAB sash extrusion. Also used on very early Millard and Viscount vans.

FEATURES

- Per metre
- 100m rolls



VISCOUNT POW GLAZE-WDG PER M

008555

Glazing rubber for older viscount style push out windows.

FEATURES

- Per metre
- 100m rolls

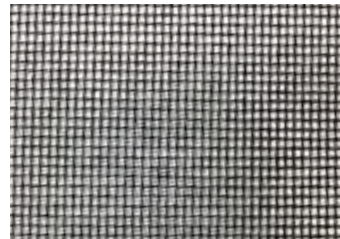

FLY SCREEN MESH

015662

FEATURES

- Sold per metre
- 910 x 1000

VIENTO BLINDS



VIENTO BLIND

- 050330 300 X 900
- 050321 450 X 1100
- 050331 900 X 700
- 050329 900 X 900

Suitable for Viento windows



GATEWAY

- 043084 450 X 1175
- 043086 565 X 1175

FEATURES

- 4 Radius Corners
- Double Glazed
- 27mm Clamp
- Black



VIENTO LOCK ASSEMBLY

043759

VIENTO REPLACEMENT WINDOW SASH ONLY 450X1100

050014



WIND OUT WINDOW 45 DEGREE CONTROL BOX

PART NO.	DESCRIPTION
010175	WIND OUT WINDOW CONTROL BOX LGE R/H
010176	WIND OUT WINDOW CONTROL BOX LGE L/H
010177	WIND OUT WINDOW CONTROL BOX SML R/H
010178	WIND OUT WINDOW CONTROL BOX SML L/H
010199	WIND OUT WINDOW HANDLE



WIND OUT WINDOW CONTROL BOX - BLACK

- 010189 LGE R/H 295 X 30 X 30MM
- 010190 LGE L/H 295 X 30 X 30MM
- 010191 SML R/H 190 X 30 X 30MM
- 010192 SML L/H 190 X 30 X 30MM
- 010193 WIND OUT WINDOW LINK BOX WITH SEAL
- 010197 WIND OUT WINDOW HANDLE ASSEMBLY - BLACK
- 010204 WIND OUT WINDOW END PLUG



WIND OUT WINDOW SLIDE LOCK ASSY BLACK

010196

Common sliding catch used on winding windows.

FEATURES

- Black
- Sold as a set (1 lock)



WIND OUT WINDOW CROSS SHAFT

Replacement cross shaft. 2RC (SUITS ODYSSEY & JUPITER)

- 010207 FOR 762MM WIDE WINDOW
- 010208 FOR 914MM WIDE WINDOW
- 010210 FOR 1175MM WIDE WINDOW
- 010211 FOR 1524MM WIDE WINDOW
- 010213 FOR 1630MM WIDE WINDOW



WIND OUT WINDOW CNR INSERT

- 010202 NYLON BLACK
- 010203 DIE-CAST

Used in top corner of many wind out windows



WIND OUT WINDOW CROSS SHAFT SUPPORT

010205

FEATURES

- Supports the middle of the cross shaft from winder box to winder box
- Black



Odyssey 4SC Doors	245
Odyssey 2RC Doors	247
Odyssey 4RC Doors	248
Odyssey Premium 2RC & 4RC Doors	249
Camec Vista 2RC Doors	252
Camec Aero Doors	253
Miscellaneous Main Doors	255
Camec Door Blinds	256
Spare Parts	257
Keyless Entry	258
Picnic Table	259
Camec 2RC,4SC & 4RC Access Doors	260
Camec Boot Storage Doors	261
One Key System	262

ODYSSEY 4SC DOOR



ODYSSEY 4 SQUARE CORNER DOORS

Available in a range of sizes to suit most RV designs the Odyssey 4 Square door has a light but strong main door infill and a one piece outer door. Available in white, jet black, polished grey or cristal silver, with a white or black frame, left or right hinge set up and featuring a 3 point lock system and aluminium grille mesh security door with fly screen. The stylish Odyssey tinted single glazed acrylic panel completes the Odyssey range's modern look.

FEATURES

- One piece door panel
- PVC infill for greater strength
- Black grill mesh security door with fly-screen
- White, black, polished grey or cristal silver infill colours.
- Fully customizable checker plate door infills available in any height.
Please contact Camec for further details
- Lower Venturi vent in white or black

SPECIFICATIONS

- Frame Colour: black or white
- Left or right hand hinge set up
- Slim look main frame extrusion

PART NO.	SIZE	INFILL	HINGE	VENT	FRAME
044633	1425 X 622	JET BLACK	LHH	NO	BLACK
051308	1425 X 622	JET BLACK	LHH	MAIN DOOR ONLY - SPARE PART	
041126	1540 X 572	SMOOTH WHITE	RHH	WHITE	BLACK
043188	1540 X 572	SMOOTH WHITE	LHH	WHITE	BLACK
041136	1540 X 572	SMOOTH WHITE	LHH	WHITE	WHITE
041137	1540 X 572	SMOOTH WHITE	RHH	WHITE	WHITE
041976	1540 X 622	SMOOTH CRISTAL SILVER	LHH	BLACK	BLACK
041977	1540 X 622	SMOOTH CRISTAL SILVER	RHH	BLACK	BLACK
042011	1540 X 622	POLISHED GREY	RHH	BLACK	BLACK
043764	1540 X 622	SMOOTH WHITE	RHH	BLACK	BLACK
041138	1540 X 622	SMOOTH WHITE	LHH	WHITE	WHITE
041139	1540 X 622	SMOOTH WHITE	RHH	WHITE	WHITE
050079	1540 X 622	JET BLACK	LHH	BLACK	BLACK
041140	1623 X 572	SMOOTH WHITE	RHH	WHITE	BLACK
041141	1623 X 572	SMOOTH WHITE	LHH	WHITE	WHITE
041142	1623 X 572	SMOOTH WHITE	RHH	WHITE	WHITE
041978	1623 X 622	SMOOTH CRISTAL SILVER	LHH	BLACK	BLACK
041979	1623 X 622	SMOOTH CRISTAL SILVER	RHH	BLACK	BLACK
042005	1623 X 622	STUCCO WHITE	RHH	WHITE	WHITE
044200	1623 X 622	SMOOTH JET BLACK	LHH	BLACK	BLACK
044201	1623 X 622	SMOOTH JUST BLACK	RHH	BLACK	BLACK
041143	1623 X 622	SMOOTH WHITE	LHH	WHITE	BLACK
041144	1623 X 622	SMOOTH WHITE	RHH	WHITE	BLACK
041145	1623 X 622	SMOOTH WHITE	LHH	WHITE	WHITE
041147	1623 X 622	SMOOTH WHITE	RHH	WHITE	WHITE
041148	1690 X 622	SMOOTH WHITE	LHH	WHITE	BLACK
041149	1690 X 622	SMOOTH WHITE	RHH	WHITE	BLACK
041150	1690 X 622	SMOOTH WHITE	LHH	WHITE	WHITE
041151	1690 X 622	SMOOTH WHITE	RHH	WHITE	WHITE

PART NO.	SIZE	INFILL	HINGE	VENT	FRAME
041983	1723 X 572	SMOOTH CRISTAL SILVER	RHH	BLACK	BLACK
041152	1723 X 572	SMOOTH WHITE	LHH	WHITE	WHITE
041153	1723 X 572	SMOOTH WHITE	RHH	WHITE	WHITE
042891	1750 X 572	SMOOTH WHITE	LHH	WHITE	BLACK
041154	1750 X 572	SMOOTH WHITE	RHH	WHITE	BLACK
041984	1750 X 622	SMOOTH CRISTAL SILVER	LHH	BLACK	BLACK
041985	1750 X 622	SMOOTH CRISTAL SILVER	RHH	BLACK	BLACK
042006	1750 X 622	STUCCO WHITE	LHH	WHITE	BLACK
042007	1750 X 622	STUCCO WHITE	RHH	WHITE	BLACK
042008	1750 X 622	STUCCO WHITE	LHH	WHITE	WHITE
042009	1750 X 622	STUCCO WHITE	RHH	WHITE	WHITE
042016	1750 X 622	POLISHED GREY	LHH	BLACK	BLACK
042806	1750 X 622	JET BLACK	LHH	BLACK	BLACK
042807	1750 X 622	JET BLACK	RHH	BLACK	BLACK
041155	1750 X 622	SMOOTH WHITE	LHH	WHITE	BLACK
041156	1750 X 622	SMOOTH WHITE	RHH	WHITE	BLACK
041157	1750 X 622	SMOOTH WHITE	LHH	WHITE	WHITE
041158	1750 X 622	SMOOTH WHITE	RHH	WHITE	WHITE
042017	1750 X 622	POLISHED GREY	RHH	BLACK	BLACK
041987	1822 X 622	SMOOTH CRISTAL SILVER	RHH	BLACK	BLACK
041162	1822 X 622	SMOOTH WHITE	LHH	WHITE	WHITE
041163	1822 X 622	SMOOTH WHITE	RHH	WHITE	WHITE
043093	1822 X 622	JET BLACK	LHH	BLACK	BLACK
043094	1822 X 622	JET BLACK	RHH	BLACK	BLACK
041160	1822 X 622	SMOOTH WHITE	LHH	WHITE	BLACK
041161	1822 X 622	SMOOTH WHITE	RHH	WHITE	BLACK
051267	1822 X 622	SMOOTH WHITE S/S MESH	LHH	WHITE	BLACK
051281	1822 X 622	BLACK S/S MESH	RHH	BLACK	BLACK
051268	1822 X 622	SMOOTH WHITE S/S MESH	LHH	WHITE	WHITE
051269	1822 X 622	SMOOTH WHITE S/S MESH	LHH	WHITE	WHITE
041989	1908 X 622	SMOOTH CRISTAL SILVER	RHH	BLACK	BLACK
042097	1908 X 622	SMOOTH WHITE	LHH	WHITE	BLACK
041164	1908 X 622	SMOOTH WHITE	RHH	WHITE	BLACK
041165	1908 X 622	SMOOTH WHITE	LHH	WHITE	WHITE
041166	1908 X 622	SMOOTH WHITE	RHH	WHITE	WHITE
051279	1908 X 622	SMOOTH WHITE S/S MESH	LHH	WHITE	BLACK
051270	1908 X 622	SMOOTH WHITE S/S MESH	LHH	WHITE	BLACK
051271	1908 X 622	SMOOTH WHITE S/S MESH	LHH	WHITE	WHITE
051272	1908 X 622	SMOOTH WHITE S/S MESH	RHH	WHITE	WHITE
041989	1908 X 622	SMOOTH CRISTAL SILVER	RHH	BLACK	BLACK

4SC CAMPER DOOR

044075	1822 X 522	2 PIECE LOWER SECT 830MM UPPER 990MM BLACK	RHH	BLACK	BLACK
--------	------------	---	-----	-------	-------

ODYSSEY 2RC DOORS



ODYSSEY 2 RADIUS CORNER DOORS

The Camec Odyssey 2 Radius Corner door features a light but strong main door infill and one piece outer door and is available in many infill colours, with a white or black frame. The Odyssey 2 Radius Corner door come with a left or right hinge set up, standard 3 point lock system and aluminium grill mesh security door with fly screen. The tinted single glazed acrylic panel completes the Odyssey range's modern look.

FEATURES

- 878mm wide access doors available to suit wheelchairs*
- One piece door panel
- PVC infill for greater strength
- Black grill mesh security door with fly-screen
- White, grey, black or silver infill colours
- Fully customizable checker plate door infill available in any height. Please contact Camec for further details
- Lower Venturi vent in white or black

SPECIFICATIONS

- Frame Colour: black or white
- Left or right hand hinge set up
- Slim look main frame extrusion

PART NO.	SIZE	INFILL	HINGE	VENT	FRAME
042801	1750 X 622	STUCCO WHITE	LHH	WHITE	BLACK
043369	*1750 X 878	JET BLACK	LHH	BLACK	BLACK
043370	*1750 X 878	JET BLACK	RHH	BLACK	BLACK
043493	*1750 X 878	SMOOTH WHITE	LHH	WHITE	WHITE
043494	*1750 X 878	SMOOTH WHITE	RHH	WHITE	WHITE
041169	1623 X 572	SMOOTH WHITE	LHH	WHITE	WHITE
041170	1623 X 572	SMOOTH WHITE	RHH	WHITE	WHITE
042284	1623 X 622	SMOOTH WHITE	LHH	NO VENT	WHITE
041936	1623 X 622	SMOOTH WHITE	RHH	WHITE	BLACK
041937	1623 X 622	SMOOTH WHITE	LHH	WHITE	WHITE
041938	1623 X 622	SMOOTH WHITE	RHH	WHITE	WHITE
044627	1623 X 622	SMOOTH WHITE	LHH	WHITE	WHITE
044631	1623 X 622	CRISTAL SILVER	LHH	BLACK	BLACK
041172	1690 X 622	SMOOTH WHITE	RHH	WHITE	BLACK
041175	1723 X 572	SMOOTH WHITE	LHH	WHITE	WHITE
041176	1723 X 572	SMOOTH WHITE	RHH	WHITE	WHITE
041178	1750 X 622	SMOOTH WHITE	RHH	WHITE	BLACK
041180	1750 X 622	SMOOTH WHITE	RHH	WHITE	WHITE
042099	1750 X 622	DIAMOND SILVER	LHH	BLACK	BLACK
042100	1750 X 622	DIAMOND SILVER	RHH	BLACK	BLACK
042477	1750 X 622	CRISTAL SILVER	RHH	WHITE	BLACK
042802	1750 X 622	STUCCO WHITE	RHH	WHITE	BLACK
042808	1750 X 622	JET BLACK	LHH	BLACK	BLACK
042809	1750 X 622	JET BLACK	RHH	BLACK	BLACK
041177	1750 X 622	SMOOTH WHITE	LHH	WHITE	BLACK
041179	1750 X 622	SMOOTH WHITE	LHH	WHITE	WHITE
042020	1750 X 622	POLISHED GREY	RHH	BLACK	BLACK
042478	1750 X 622	CRISTAL SILVER	LHH	WHITE	BLACK
050046	1750 X 622	SMOOTH WHITE	LHH	BLACK	BLACK

PART NO.	SIZE	INFILL	HINGE	VENT	FRAME
044194	1750 X 622	ONYX WHITE	LHH	BLACK	BLACK
042084	1750 X 622	NEW AGE GREY	RHH	BLACK	BLACK
042085	1750 X 622	JURGEN STUCCO YELLOW TONE	RHH	BLACK	WHITE
042086	1750 X 622	JURGEN STUCCO YELLOW TONE	LHH	BLACK	WHITE
050539	1750 X 622	ONYX WHITE	RHH	BLACK	BLACK
050077	1750 X 878	JET BLACK	LHH	BLACK	BLACK
050078	1750 X 878	JET BLACK	RHH	BLACK	BLACK
041181	1822 X 622	SMOOTH WHITE	LHH	WHITE	BLACK
042914	1822 X 622	CRISTAL SILVER	RHH	BLACK	BLACK
042915	1822 X 622	CRISTAL SILVER	LHH	BLACK	BLACK
043095	1822 X 622	JET BLACK	LHH	BLACK	BLACK
043096	1822 X 622	JET BLACK	RHH	BLACK	BLACK
041182	1822 X 622	SMOOTH WHITE	RHH	WHITE	BLACK
041183	1822 X 622	SMOOTH WHITE	LHH	WHITE	WHITE
041184	1822 X 622	SMOOTH WHITE	RHH	WHITE	WHITE
051275	1822 X 622	SMOOTH WHITE	RHH	WHITE	WHITE
041185	1908 X 622	SMOOTH WHITE	LHH	WHITE	BLACK
051276	1908 X 622	SMOOTH WHITE S/S MESH	LHH	SMOOTH WHITE	BLACK
041186	1908 X 622	SMOOTH WHITE	RHH	SMOOTH WHITE	BLACK
041187	1908 X 622	SMOOTH WHITE	LHH	SMOOTH WHITE	WHITE

ODYSSEY 4RC DOORS



The Camec Odyssey 4 Radius Corner door features a light but strong main door infill and one piece outer door. Available in assorted coloured infill with a white or black frame, the Odyssey 4 Radius Corner door come with a left or right hinge set up, standard 3 point lock system and aluminium grill mesh security door with fly screen. The tinted single glazed acrylic panel completes the Odyssey range's modern look.

FEATURES

- One piece door panel
- PVC infill for greater strength
- Black grill mesh security door with fly screen
- Fully customizable checker plate door infill available in any height. Please contact Camec for further details
- Lower Venturi vent in white or black

SPECIFICATIONS

- Frame Colour: black or white
- Left or right hand hinge set up
- Slim look main frame extrusion

PART NO.	SIZE	INFILL	HINGE	VENT	FRAME
041197	1723 X 572	SMOOTH WHITE	LHH	WHITE	WHITE
041201	1750 X 622	SMOOTH WHITE	LHH	WHITE	WHITE
041202	1750 X 622	SMOOTH WHITE	RHH	WHITE	WHITE
041195	1723 X 622	SMOOTH WHITE	LHH	WHITE	BLACK
041203	1822 X 622	SMOOTH WHITE	LHH	WHITE	BLACK
041205	1822 X 622	SMOOTH WHITE	LHH	WHITE	WHITE
041206	1822 X 622	SMOOTH WHITE	RHH	WHITE	WHITE
041207	1908 X 622	SMOOTH WHITE	LHH	WHITE	BLACK
051277	1908 X 622	SMOOTH WHITE S/S MESH	LHH	WHITE	WHITE

ODYSSEY PREMIUM 2RC DOORS



ODYSSEY PREMIUM 2RC DOORS

Odyssey Premium 2 and 4 Radius Corner doors offer an extensive list of features. You can choose from white, grey, black or silver in the 2RC, or white or silver in the 4RC. Featuring a double glazed tinted acrylic window panel, the Odyssey Premium door combine the ultimate security of Camec's 3 point locking system combined with our patented RVSafe stainless steel security door.

Simply the safest and most stylish door on the market.

FEATURES

- RVSafe security door
- One piece door panel
- PVC infill for greater strength
- Range of infill colours

SPECIFICATIONS

- Frame Colour: black or white
- Left or right hand hinge set up
- Slim look main frame extrusion

All Odyssey Premium Doors can be purchased with keyless entry and or blinds (Odyssey Door Blind or Premium Door Blind). Some listed are already packaged, but call to enquire about packaging to suit your desired configuration.

PART NO.	SIZE	INFILL	HINGE	VENT	FRAME
044774	1425 X 572	SMOOTH WHITE	RHH	NO	WHITE
041212	1540 X 572	SMOOTH WHITE	RHH	WHITE	WHITE
043854	1540 X 572	JET BLACK	RHH	BLACK	BLACK
041213	1623 X 572	SMOOTH WHITE	LHH	WHITE	WHITE
041214	1623 X 572	SMOOTH WHITE	RHH	WHITE	WHITE
042105	1623 X 622	POLISHED GREY	RHH	BLACK	BLACK
042107	1623 X 622	SMOOTH WHITE	RHH	WHITE	BLACK
041215	1690 X 622	SMOOTH WHITE	LHH	WHITE	WHITE
041216	1690 X 622	SMOOTH WHITE	RHH	WHITE	WHITE
041994	1690 X 622	SMOOTH CRISTAL SILVER	LHH	BLACK	BLACK
041995	1690 X 622	SMOOTH CRISTAL SILVER	RHH	BLACK	BLACK
041218	1723 X 572	SMOOTH WHITE	RHH	WHITE	BLACK
041219	1723 X 572	SMOOTH WHITE	LHH	WHITE	WHITE
041220	1723 X 572	SMOOTH WHITE	RHH	WHITE	WHITE
041221	1750 X 622	SMOOTH WHITE	LHH	WHITE	BLACK
041222	1750 X 622	SMOOTH WHITE	RHH	WHITE	BLACK
041223	1750 X 622	SMOOTH WHITE	LHH	WHITE	WHITE
041224	1750 X 622	SMOOTH WHITE	RHH	WHITE	WHITE
041998	1750 X 622	SMOOTH CRISTAL SILVER	LHH	BLACK	BLACK
041999	1750 X 622	SMOOTH CRISTAL SILVER	RHH	BLACK	BLACK
042101	1750 X 622	DIAMOND SILVER	LHH	BLACK	BLACK
042102	1750 X 622	DIAMOND SILVER	RHH	BLACK	BLACK
042109	1750 X 622	POLISHED GREY	RHH	BLACK	BLACK
042110	1750 X 622	POLISHED GREY	LHH	BLACK	BLACK
042810	1750 X 622	JET BLACK	LHH	BLACK	BLACK
042811	1750 X 622	JET BLACK	RHH	BLACK	BLACK
044808	1750 X 622	JET BLACK KEYLESS ENTRY	LHH	BLACK	BLACK
043598	1750 X 622	ONYX WHITE	LHH	BLACK	BLACK
041225	1822 X 622	SMOOTH WHITE	LHH	WHITE	BLACK
041226	1822 X 622	SMOOTH WHITE	RHH	WHITE	BLACK
041227	1822 X 622	SMOOTH WHITE	LHH	WHITE	WHITE

PART NO.	SIZE	INFILL	HINGE	VENT	FRAME
041228	1822 X 622	SMOOTH WHITE	RHH	WHITE	WHITE
041802	1822 X 622	SMOOTH CRISTAL SILVER	RHH	BLACK	BLACK
041803	1822 X 622	SMOOTH CRISTAL SILVER	LHH	BLACK	BLACK
043351	1822 X 622	JET BLACK	RHH	BLACK	BLACK
043352	1822 X 522	JET BLACK	LHH	BLACK	BLACK
043354	1822 X 622	STUCCO WHITE	LHH	BLACK	BLACK
041229	1908 X 622	SMOOTH WHITE	LHH	WHITE	BLACK
041230	1908 X 622	SMOOTH WHITE	RHH	WHITE	BLACK
041231	1908 X 622	SMOOTH WHITE	LHH	WHITE	WHITE
041232	1908 X 622	SMOOTH WHITE	RHH	WHITE	WHITE
042002	1908 X 622	CRISTAL SILVER	LHH	BLACK	BLACK
042003	1908 X 622	SMOOTH CRISTAL SILVER	RHH	BLACK	BLACK
043299	1908 X 622	SMOOTH WHITE	RHH	NO VENT	BLACK
043996	1908 X 622	JET BLACK	LHH	BLACK	BLACK
042043	1623 X 572	SMOOTH WHITE	LHH	WHITE	WHITE
042044	1623 X 572	SMOOTH WHITE	RHH	WHITE	WHITE
042041	1723 X 572	SMOOTH WHITE	LHH	WHITE	WHITE
042042	1723 X 572	SMOOTH WHITE	RHH	WHITE	WHITE
050106	1908 X 622	SMOOTH WHITE	LHH	NIL	WHITE
051376	1822 X 622	SMOOTH WHITE	LHH	NIL	BLACK
051377	1822 X 622	SMOOTH WHITE	RHH	NIL	BLACK
051445	1822 X 622	JET BLACK	LHH	NIL	BLACK
051446	1822 X 622	JET BLACK	RHH	NIL	BLACK
050366	1908 X 622	JET BLACK	RHH	BLACK	BLACK
050413	1425 X 572	SMOOTH WHITE	RHH	WHITE	WHITE
043284	1750 X 622	SMOOTH CRISTAL SILVER	RHH	BLACK	BLACK
041233	1540 X 572	SMOOTH WHITE	LHH	WHITE	WHITE
041234	1540 X 572	SMOOTH WHITE	RHH	WHITE	WHITE
041241	1723 X 572	SMOOTH WHITE	LHH	WHITE	WHITE
041245	1750 X 622	SMOOTH WHITE	LHH	WHITE	WHITE
041246	1750 X 622	SMOOTH WHITE	RHH	WHITE	WHITE
041249	1822 X 622	SMOOTH WHITE	LHH	WHITE	WHITE
041250	1822 X 622	SMOOTH WHITE	RHH	WHITE	WHITE
041254	1908 X 622	SMOOTH WHITE	RHH	WHITE	WHITE

ODYSSEY PREMIUM 4RC DOORS



ODYSSEY PREMIUM 4RC DOORS

PART NO.	SIZE	INFILL	HINGE	VENT	FRAME
41233	1540 X 572	SMOOTH WHITE	LHH	WHITE	WHITE
41234	1540 X 572	SMOOTH WHITE	RHH	WHITE	WHITE
41241	1723 X 572	SMOOTH WHITE	LHH	WHITE	WHITE
41245	1750 X 622	SMOOTH WHITE	LHH	WHITE	WHITE
41246	1750 X 622	SMOOTH WHITE	RHH	WHITE	WHITE
43284	1750 X 622	SMOOTH SILVER	RHH	BLACK	BLACK
41250	1822 X 622	SMOOTH WHITE	RHH	WHITE	WHITE
41254	1908 X 622	SMOOTH WHITE	RHH	WHITE	WHITE
041249	1822 X 622	SMOOTH WHITE	LHH	WHITE	WHITE

CAMEC VISTA 2RC DOORS



CAMEC VISTA 2RC DOORS

FEATURES

- Modern and stylish door design
- Features stylish glazed acrylic panels
- Camec RVSafe security door as standard
- Camec 3 Point locking system as standard
- Full weather and dust seal
- Manufactured and assembled in Australia

PART NO.	SIZE	INFILL	HINGE	VENT	BLIND	KEYLESS
044157	1750 X 622	BLACK	RHH	BLACK	YES	NO
044159	1822 X 622	BLACK	RHH	BLACK	YES	NO
044160	1822 X 622	BLACK	LHH	BLACK	YES	NO
044661	1822 X 622	SMOOTH WHITE	RHH	BLACK	YES	NO
044679	1822 X 622	SMOOTH WHITE	LHH	BLACK	YES	YES
044942	1822 X 622	SMOOTH WHITE	LHH	NO	NO	NO
044158	1750X 622	JET BLACK	LHH	BLACK	BLACK	NO
044160	1822 X 622	JET BLACK	LHH	BLACK	BLACK	NO
044447	1750 X 622	JET BLACK	RHH	BLACK	BLACK	YES
044449	1822 X 622	JET BLACK	RHH	BLACK	BLACK	YES
044452	1908 X 622	JET BLACK	LHH	BLACK	BLACK	YES
044942	1822 X 622	SMOOTH WHITE	LHH	NO	WHITE	NO
044660	1750 X 622	SMOOTH WHITE	LHH	BLACK	WHITE	NO
044661	1822 X 622	SMOOTH WHITE	RHH	BLACK	WHITE	NO
044679	1822 X 622	SMOOTH WHITE	LHH	BLACK	WHITE	YES
044166	1750X 622	JET BLACK	LHH	BLACK	BLACK	NO
050296	1750X 622	SMOOTH WHITE	RHH	NO	WHITE	NO

CAMEC AERO 2 RADIUS CORNER DOORS



ODYSSEY AERO DOOR

FEATURES

- RVSafe security door
- Stylish one piece door panel design with integrated flat tinted acrylic giving a sleek aerodynamic feel
- PVC infill for greater strength
- Range of colours available
- Door blind option available
- Camec can further customize sizes, shapes and configurations. Please enquire about other possibilities

SPECIFICATIONS

- Frame colours: Black or white
- Left or right hand hinge setup
- Slim look main frame extrusion
- * Off road seal option
- ** Keyless entry option
- ODY = Odyssey Blind, PREM = Premium Blind



CAMEC ODYSSEY AERO 2 RADIUS CORNER DOORS

PART NO.	SIZE	INFILL	FRAME	VENT	HINGE	BLIND
050099	1425 X 572	BLACK	BLACK	BLACK	RHH	NO
044834	1750 X 622	BLACK	BLACK	BLACK	LHH	NO
044835	1750 X 622	BLACK	BLACK	BLACK	RHH	NO
044876	1750 X 622	SMOOTH WHITE	BLACK	BLACK	LHH	NO
044877	1750 X 622	SMOOTH WHITE	BLACK	BLACK	RHH	NO
044838	1750 X 622	CRISTAL SILVER	BLACK	BLACK	LHH	NO
044839	1750 X 622	CRISTAL SILVER	BLACK	BLACK	RHH	NO
044840	1822 X 622	BLACK	BLACK	BLACK	LHH	NO
044841	1822 X 622	BLACK	BLACK	BLACK	RHH	NO
044846	1908 X 622	BLACK	BLACK	BLACK	LHH	NO
044847	1908 X 622	BLACK	BLACK	BLACK	RHH	NO
050063	1908 X 622	SMOOTH WHITE	BLACK	BLACK	LHH	NO
050064	1908 X 622	SMOOTH WHITE	BLACK	BLACK	RHH	NO
044795	1623 X 622	BLACK	BLACK* OFF ROAD SEAL	BLACK	LHH	ODY
044796	1623 X 622	BLACK	BLACK* OFF ROAD SEAL	BLACK	RHH	ODY
044828	1750 X 622	CRISTAL SILVER	BLACK* OFF ROAD SEAL	BLACK	RHH	ODY
044852	1750 X 622	BLACK	BLACK	BLACK	LHH	ODY
044853	1750 X 622	BLACK	BLACK	BLACK	RHH	ODY
044854	1750 X 622	SMOOTH WHITE	WHITE	WHITE	LHH	ODY
044855	1750 X 622	SMOOTH WHITE	WHITE	WHITE	RHH	ODY
044884	1750 X 622	SMOOTH WHITE	BLACK	BLACK	LHH	ODY
044885	1750 X 622	SMOOTH WHITE	BLACK	BLACK	RHH	ODY
044856	1750 X 622	CRISTAL SILVER	BLACK	BLACK	LHH	ODY
044857	1750 X 622	CRISTAL SILVER	BLACK	BLACK	RHH	ODY
044858	1822 X 622	BLACK	BLACK	BLACK	LHH	ODY
044859	1822 X 622	BLACK	BLACK	BLACK	RHH	ODY
044860	1822 X 622	SMOOTH WHITE	WHITE	WHITE	LHH	ODY
044864	1908 X 622	BLACK	BLACK	BLACK	LHH	ODY
044865	1908 X 622	BLACK	BLACK	BLACK	RHH	ODY
044866	1908 X 622	SMOOTH WHITE	WHITE	WHITE	LHH	ODY

PART NO.	SIZE	INFILL	FRAME	VENT	HINGE	BLIND
044907	1908 X 622	BLACK	BLACK	BLACK	LHH	PREM
044908	1908 X 622	BLACK	BLACK	BLACK	RHH	PREM
050785	1750 X 622	BLACK	BLACK	BLACK	LHH	PREM
050787	1750 X 622	BLACK	BLACK	BLACK	RHH	PREM
050783	1750 X 622	CRISTAL SILVER	BLACK	BLACK	RHH	PREM
051482	1908 X 622	BLACK	BLACK	BLACK	LHH	OUTER DOOR ONLY
051483	1908 X 622	BLACK	BLACK	BLACK	RHH	OUTER DOOR ONLY
050895	1750 X 622	BLACK	BLACK	BLACK	LHH	OUTER DOOR ONLY
050896	1750 X 622	BLACK	BLACK	BLACK	RHH	OUTER DOOR ONLY

CAMEC AERO 4 SQUARE CORNER DOOR



PART NO.	SIZE	INFILL	FRAME	VENT	HINGE	BLIND
050010	1750 X 622	BLACK	BLACK	BLACK	LHH	NO
050011	1750 X 622	BLACK	BLACK	BLACK	RHH	NO
050012	1750 X 622	BLACK	BLACK	BLACK	LHH	ODY
050013	1750 X 622	BLACK	BLACK	BLACK	RHH	ODY
044882	1822 X 622	BLACK	BLACK	BLACK	LHH	NO
044883	1822 X 622	BLACK	BLACK	BLACK	RHH	NO
044890	1822 X 622	BLACK	BLACK	BLACK	LHH	ODY
044891	1822 X 622	BLACK	BLACK	BLACK	RHH	ODY

PART NO.	DESCRIPTION	HINGE	DETAILS
051447	4SQ AERO DR WH	LHH	1723 X 572 SMW S/S MESH NO BLIND
051449	4SQ AERO DR WH	LHH	1822 X 622 SMW S/S MESH NO BLIND
051448	4SQ AERO DR WH	RHH	1723 X 572 SMW S/S MESH NO BLIND
051450	4SQ AERO DR WH	RHH	1822 X 622 SMW S/S MESH NO BLIND

CAMEC AERO 4 RADIUS CORNER DOOR

PART NO.	DESCRIPTION	HINGE	DETAILS
050891	AERO 4RC DR	LHH	1850 X 672 SS MESH NO VENTS
050893	AERO 4RC DR BLD	LHH	1850 X 672 SS MESH NO VENTS BLIND

MISCELLANEOUS MAIN DOORS



CAMEC MAIN DOORS

038961 CAMEC 2RC DOOR 1750X672 WH RHH
041061 CAMEC 2RC DOOR 1750X622 BL LHH - CRISTAL INFILL

027791 CAMEC MK1 DOOR 1822X672&SEC/MESH
027792 CAMEC MK1 DOOR 1822X672&SEC/MESH
043595 CAMEC MK1 DOOR 1822X672&SEC/MESH
051165 CAMEC MK1 DOOR 1822X622 NO VENT
051288 CAMEC MK1 DOOR 1822X672&SS/MESH
051289 CAMEC MK1 DOOR 1822X672&SS/MESH



013038 CAMEC MK2 DOOR 1908X762 WH RHH
013039 CAMEC MK2 DOOR 1908X762 WH LHH
043953 CAMEC MK2 DOOR 1623X572 OUTER DOOR ONLY
043593 CAMEC MK2 DOOR 1822X672 ADOOR LHH
050920 CAMEC MK2 DOOR 1750X622 BSMW LHH
050921 CAMEC MK2 DOOR 1750X622 BSMW RHH



042867 CAMEC MK6 DOOR 1750X622 BL LHH
042868 CAMEC MK6 DOOR 1750X622 BL RHH

015099 RAPID DOOR (FRONT) 1210X2054MM
015102 RAPID DOOR (REAR) 1210X2054MM

043389 GLIDER DOOR SMOOTH CRI SILVER
043393 GLIDER DOOR SMOOTH WHITE
044066 GLIDER DOOR STUCCO CRI SILVER
044068 GLIDER DOOR STUCCO WHITE
050262 GLIDER DOOR STUCCO WHITE NEW AGE

035451 CARAVAN SERVICE DOOR 700 X 305



CAMEC DOOR BLINDS



CAMEC PREMIUM DOOR BLIND

To suit Camec Premium and Vista doors.

FEATURES

- Engineered in Australia
- Fully integrated blind solution
- For any Camec premium security door
- Colour: Black
- Easy to fit
- Suitable for left or right handed doors
- Suitable for DIY installation
- Micro chain drive
- Full length blind

PART NO.	TO SUIT DOOR	HINGE
044390	OSYSSEY PREMIUM DOOR 572W 1750H & UNDER	LHH
044391	ODYSSEY PREMIUM DOOR 572W 1750H & UNDER	RHH
044392	ODYSSEY PREMIUM DOOR 622W 1750H & UNDER	LHH
044393	ODYSSEY PREMIUM DOOR 622W 1750H	RHH
044395	ODYSSEY PREMIUM DOOR 622W 1822 H & 1908H & UNDER	RHH

PART NO.	TO SUIT DOOR	HINGE
044383	VISTA DOOR BLIND 1750 X 622	LHH
044384	VISTA DOOR BLIND 1750 X 622	RHH
044385	VISTA DOOR BLIND 1822 X 622	LHH
044386	VISTA DOOR BLIND 1822 X 622	RHH
044388	VISTA DOOR BLIND 1908 X 622	RHH

*NOTE: Hinge side listed is looking from the inside of the van out. Chain will then be on the hinge, not lock side.



SPARE PARTS

PART NO.	TO SUIT DOOR	HINGE
044617	ODY PREM / VISTA DOOR BLIND	PELMET COVER - 572W
044618	ODY PREM / VISTA DOOR BLIND	PELMET COVER - 622W
044389	ODY PREM / VISTA DOOR BLIND	SIDE RAIL ALL SIZES
044619	ODY PREM / VISTA DOOR BLIND	PELMET END CAPS - SET

ODYSSEY DOOR BLIND - UNIVERSAL BLIND TO FIT STANDARD ODYSSEY DOORS ONLY

PART NO.	TO SUIT DOOR	OVERALL DIMENSIONS
044610	ODYSSEY DR BLIND T/S 572 X WIDTH	BLACK 475W X 1000MM
044611	ODYSSEY DR BLIND T/S 622 WIDTH	BLACK 530W X 1080MM
050617	ODYSSEY DR BLIND T/S 672 WIDTH	BLACK 565W X 1060MM

Suits left or right hinged doors. Size listed is door cut out size.



SPARE PARTS



PART NO.	PRODUCT DESCRIPTION
039716	CAMEC NEW STYLE DOOR VENT WHITE
040460	WHITE INTERNAL 2RC/4RC FLEXI DR TRIM
040965	CAMEC NEW STYLE DR VENT BLACK
050982	TOP/BOTTOM FLY FRAME 2/4RC CAMEC DR 572 BLACK
050983	TOP/BOTTOM FLY FRAME 2/4RC CAMEC DR 622 BLACK
043921	2RC CAMEC ROUND CORNER FLY FRM WHITE
013553	PANORAMA DOOR LOCK ASSY COMP KEYED ALIKE
013552	PANORAMA DOOR LOCK ASSY COMP
013554	PANORAMA DOOR LOCK - OUTER
013555	PANORAMA DOOR LOCK - INNER
013556	PANORAMA DOOR - LOCK STRIKER PLATE - BLACK
013566	PANORAMA DOOR SCREEN SLIDE
013574	PANORAMA DOOR - PLASTIC CNR INSERT
013578	PANORAMA DOOR - WEATHER SEAL
013579	PANORAMA DOOR HINGE - BLACK
013581	PANORAMA MKII LOCK ASSEMBLY
014374	AUSTRALITE VENTURI VENT ASSY
014379	CAMEC 3 POINT DOOR LOCK RACK
014381	CAMEC 3 POINT DOOR - INNER HANDLE KIT
014382	CAMEC 3 POINT DOOR - OUTER HANDLE KIT
014383	CAMEC 3 POINT DOOR - LOCK STRIKE
014384	CAMEC 3 POINT DOOR - MAIN LOCK LH
014385	CAMEC 3 POINT DOOR - MAIN LOCK RH
014386	CAMEC 3 POINT DOOR - REMOTE LATCH LH
014387	CAMEC 3 POINT DOOR - REMOTE LATCH RH
014389	CAMEC 3 POINT DOOR - LOCK CATCH PIN
039233	CAMEC 3 POINT DOOR - CENTER CATCH PIN
039273	CAMEC 3 POINT DOOR - LOCK OUTER TRIM
014390	CAMEC 3 POINT DOOR - LOCK HOOK CATCH
039316	CAMEC 3 POINT DOOR - REMOTE CATCH PIN

014392	CAMEC 3 POINT DOOR - BARREL & KEYS
039323	CAMEC 3 POINT DOOR - LHH DOOR LOCK COMP.
039324	CAMEC 3 POINT DOOR - RHH DOOR LOCK COMP.
014414	CAMEC DR FLYSCREEN CNR INSERT
014395	TRI DOOR - LOCK ASSY OUTER - BLACK
014396	TRI DOOR - LOCK ASSY COMP - BLACK
014397	TRI DOOR - LOCK ASSY COMPLETE -KEYED ALIKE BLACK
014398	TRI DOOR - INNER LOCK - BLACK
014399	TRI DOOR - LOCK STRIKE PLATE BLACK
014401	TRI DOOR - OUTER PLATE FOR LOCK-BLACK
014402	TRI DOOR - WEATHER SEAL
014403	PANORAMA/TRI DOOR TREAD SEAL
014404	TRI DOOR - MAIN DOOR 2-PCE CNR STAKE
014406	TRI DOOR EARTH STRAP
014407	TRI DOOR 4 PIECE HINGE
015624	INTERNAL DOOR TRIM X 4.38M BLACK
050083	CAMEC 3 POINT DOOR - LOCK OUTER TRIM
039376	CAMEC 2RC DOOR 4 PIECE HINGE
051334	HEAVY DUTY REMOTE CATCH PIN
038974	INTERNAL 2RC/4RC FLEXI DR TRIM
043129	DOOR PINCH WELD
043226	DOOR SANTOPRENE WEATHER SEAL
043130	DOOR BRUSH SEAL / SCHLEGEL KIT

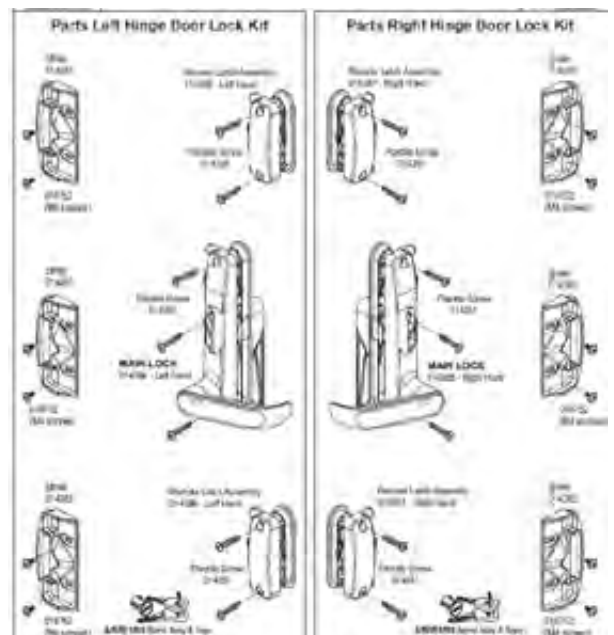

CAMEC OUTER HANDLE

014382

KEYLESS ENTRY



KEYLESS ENTRY LOCKS

PART NO.	PRODUCT NAME
044435	KEYLESS ENTRY 3-POINT LOCK LHH
044436	KEYLESS ENTRY 3-POINT LOCK RHH



KEYLESS ENTRY ACCESSORIES

PART NO.	PRODUCT NAME
042271	CAMEC ENTRY DOOR KEY BLANK PR
044442	KEYLESS ENTRY WRIST BAND BLACK
044438	KEYLESS ENTRY SPARE KEY TAG BLUE
044439	KEYLESS ENTRY SPARE KEY TAG RED
044437	KEYLESS ENTRY SPARE KEY TAG TEAL
044441 LARGE (195MM)	KEYLESS ENTRY BRACELET TEAL
044440 SMALL (180MM)	KEYLESS ENTRY BRACELET TEAL



KEYLESS ENTRY SPARE PARTS

PART NO.	PRODUCT NAME
044446	KEYLESS ENTRY BATTERY COVER RH
044444	KEYLESS ENTRY INSIDE HANDLE
044443	KEYLESS ENTRY POWERED STRIKE
044562	KEYLESS ENTRY OUTSIDE HANDLE L/HH
044705	KEYLESS ENTRY OUTSIDE HANDLE R/HH
044132	BATTERIES T/S KEYLESS ENTRY PKT 4 AA

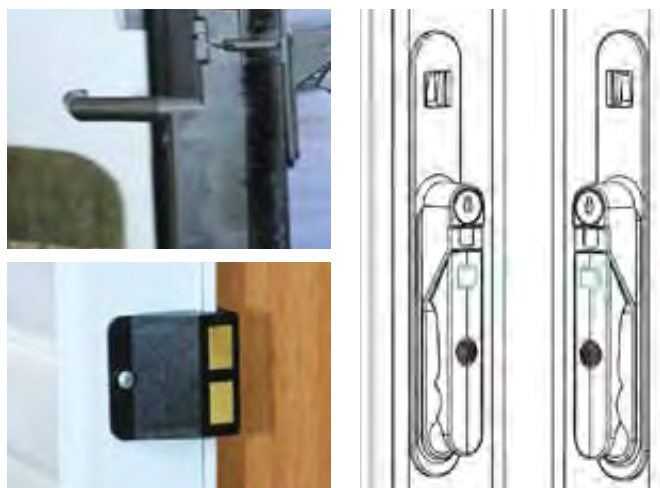

PICNIC TABLE



SURFACE MOUNTED

Similar to an access door, this laminated picnic table folds down from the side of the caravan. Ideal for any caravan or camper.

FEATURES

- Australian made
- Suit most RV vehicles
- Lockable fold down table

PART NO.	SIZE	INFILL	FRAME
040261	450 X 800	WHITE PLASTIC	WHITE



RECESS MOUNTED

PART NO.	SIZE	INFILL	FRAME
041368	450 X 800	SMOOTH CRISTAL SILVER	BLACK
043147	450 X 800	JET BLACK	BLACK
038738	450 X 800	SMOOTH WHITE / ZINC	BLACK
037988	450 X 800	POLISHED GREY/ZINC	POLISHED GREY
037989	450 X 800	SOOTH WHITE/ZINC	WHITE
037990	450 X 1000	SMOOTH WHITE/ZINC	WHITE

PICNIC TABLE SPARE PARTS

PART NO.	SIZE
035060	STAINLESS STEEL CABLE 450MM
017949	STAINLESS STEEL CABLE 565MM
042024	CAMEC PICNIC TABLE LOCK CAMEC PICNIC TABLE LOCK

CAMEC 2RC, 4SC AND 4RC ACCESS DOORS



CAMEC 2RC, 4SC AND 4RC ACCESS DOORS

Fully framed, laminated (LAM) or vented (VENT) door to suit caravan or camper. Easy to install. CAMEC One Key Fits All compatible. Left hand hinge (LHH), right hand hinge (RHH), top hinge (TH) or bottom hinge (BH)

FEATURES

- Easy to install
- CAMEC 2 lock system

4 SQUARE CORNER

PART NO.	LAMINATED / VENT	CUT OUT SIZE	INFILL	HINGE	FRAME COLOUR
037906	LAMINATED	445 X 408	SMOOTH WHITE	LHH	WHITE
038204	LAMINATED	445 X 408	SMOOTH WHITE	RHH	WHITE
040247	LAMINATED	445 X 410	SMOOTH WHITE	BH	WHITE
041127	LAMINATED	500 X 500	SMOOTH WHITE	LHH	BLACK
039027	LAMINATED	230 X 638	SMOOTH WHITE	BH	WHITE
038218	VENT	480 X 550	SMOOTH WHITE	RHH	WHITE
040662	LAMINATED	325 X 225	SMOOTH WHITE	LHH	WHITE
039121	LAMINATED	480 X 550	SMOOTH WHITE	LHH	WHITE
038501	LAMINATED	500 X 580	SMOOTH WHITE	LHH	WHITE
041666	LAMINATED - 2LK	560 X 350	SMOOTH WHITE	RHH	BLACK
040661	LAMINATED - 2LK	560 X 350	SMOOTH WHITE	RHH	WHITE
038719	LAMINATED - 2LK	762 X 457	SMOOTH WHITE	RHH	WHITE
040004	PCP-2LK	492 X 330	PROPELLER	LHH	CLEAR ANODISED
038224	PCP-2LK	492 X 645	PROPELLER	LHH	CLEAR ANODISED
037987	PCP-2LK	492 X 645	PROPELLER	RHH	CLEAR ANODISED

4 RADIUS CORNER

PART NO.	LAMINATED / VENT	SIZE	INFILL	HINGE	COLOUR
041933	VENT	390 X 554	SMOOTH WHITE	TOP	WHITE
016595	N/A	205 X 305	WHITE	N/A	WHITE
016597	N/A	525 X 280	WHITE	N/A	WHITE
016594	N/A	280 X 530	WHITE	N/A	WHITE



2 RADIUS CORNER

PART NO.	LAMINATED / VENT	SIZE	INFILL	HINGE	COLOUR
038008	LAM	230 X 457	SMOOTH WHITE	TH	WHITE
038010	LAM	230 X 500	SMOOTH WHITE	TH	WHITE
038012	LAM	230 X 762	SMOOTH WHITE	TH	WHITE
038017	LAM	280 X 457	SMOOTH WHITE	TH	WHITE
038019	LAM	280 X 762	SMOOTH WHITE	TH	WHITE

SPARE PARTS

PART NO.	PRODUCT DESCRIPTION
015642	BSD THREADED LOCK
015644	BSD LOCKING RODS & BKTS
015646	BSD AFTER/MKT GAS STRUT KIT
015653	GAS STRUT 100N W 2BALLS BLK/KB
019812	LOCK / RAPID DOOR FRONT / REAR
041111	RAPID DOOR ROD
044570	CEREDI PLASTIC HANDLE KIT
040975	EUROPA HATCH SPARE LOCK KIT



INSPECT HATCH

016600 380 X 280MM EXT

016601 600 X 350MM

UV resistant with rounded corners and anti-skid surface.

FEATURES:

- 180 degree opening waterproof
- Lock can be mounted
- White

CAMEC BOOT STORAGE DOORS



PART NO.	SIZE	INFILL	FRAME	GAS STRUTS (GAZ)
040293	380 X 1524	CHECK	BLACK	GAZ
037778	280 X 1524	SMOOTH WHITE	WHITE	N/A
037780	450 X 1175	SMOOTH WHITE	WHITE	N/A
037783	450 X 1524	SMOOTH WHITE	WHITE	N/A
039257	450 X 762	STUCCO WHITE	WHITE	GAZ
037784	380 X 1524	SMOOTH WHITE	BLACK	GAZ
037786	380 X 1524	SMOOTH WHITE	WHITE	GAZ
037807	380 X 1524	CHECK	WHITE	GAZ
041852	380 X 1524	PROPELLER	WHITE	GAZ
038211	450 X 1524	BURGUNDY VINYL	WHITE	N/A
044196	450 X 1524	STEEL PEAR CHECKER PLATE	BLACK	GAZ
037834	450 X 1524	OLYMPIC BLACK PLAIN VINYL	WHITE	GAZ
037840	450 X 1524	SMOOTH WHITE	WHITE	GAZ
038212	450 X 1524	STUCCO WHITE	WHITE	GAZ
037845	565 X 1524	MILL CHECKER PLATE	WHITE	GAZ
042524	380 X 1524	CHECK BLACK	BLACK	GAZ
037846	450 X 1524	MILL CHECKER PLATE	BLACK	GAZ
042525	450 X 1524	CHECK BLACK	BLACK	GAZ
037847	450 X 1524	MILL CHECKER PLATE	CLEAR	N/A
037848	450 X 1524	MILL CHECKER PLATE	WHITE	GAZ
043036	450 X 1524	STUCCO C'TAL SILVER	BLACK	N/A
039955	450 X 1524	MILL CHECKER PLATE	WHITE	GAZ
043518	450 X 1524	STUCCO WHITE	BLACK	GAZ
043961	450 X 1524	OLYMPIC BLACK PLAIN VINYL	BLACK	GAZ
043466	450 X 914	NO INFILL	CLEAR	GAZ
044979	450 X 1175	SMOOTH WHITE	WHITE	GAZ

ONE KEY SYSTEM

One key fits all system. Used to replace a multitude of different keys, with one. Fits Camec locks only, or Thetford access doors (requires adaptor 043073 or 040185). Additional barrels with specific key numbers can be special ordered.



1 KEY BARREL KIT

- 042087 - BARREL 2*
- 042088 - BARREL 4*
- 042089 - BARREL 6*
- 042090 - BARREL 8*
- 043071 - BARREL 12*
- 041815 - BARREL 20*

*NB: One barrel in each kit is a longer one to fit the deeper boot lock 042092, 044947, 044946



1 KEY DOOR LOCK

042093

Replacement outer housing for all Camec 3-point locking doors. This housing will enable it to accommodate the One Key Fits All barrel. Replacement housing only required for doors without a Camec logo on the handle.



ONE KEY FITS ALL T HANDLE WINDSOR RAPID DOOR NO BARREL

- 042092 REPLACEMENT HANDLE - CHROME
- 042508 BARREL ONLY, GENERIC KEY
- 042509 BARREL ONLY, KEYED TO MATCH ALL OTHER KEYS (SPECIAL ORDER)
- 044947 BLACK
- 044946 SATIN

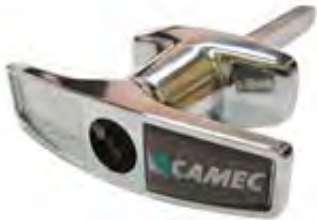

ONE KEY LARGE T HANDLE

- 044947 BLACK
- 044946 SATIN

Fits all rapid glider boot doors



PADLOCK KIT

041567 PADLOCK WITH 2 BARRELS

This chrome plated padlock is fitted with Camec's One Key Fits All barrel. Each padlock can be keyed alike to the same key as the other locks on the caravan/RV. See your Camec RV retailer if you require additional keyed alike barrels for your application. Padlock shackle diameter is 6.3mm.



ONE KEY FITS ALL T HANDLE SMALL BOOT DOOR NO BARREL

- 042091 REPLACEMENT HANDLE
- 042506 BARREL ONLY GENERIC KEY
- 042507 BARREL ONLY KEYED TO MATCH ALL OTHER KEYS (SPECIAL ORDER)

The replacement handle features a housing capable of accommodating the One Key Fits All barrel.



1 KEY FITS ALL CAMEC 2RC MINI

040268

Supplied with additional shorter cam for a van water filler application.



1 KEY ZADI ADAPTOR

- 043073 BLACK
- 040185 ALL BARREL ADAPTOR - WHITE

One key fits all adaptor to suit the Thetford access/toilet door

FEATURES

- Two adaptors per packet
- Some installation required.



1 KEY FITS ALL CAMEC TONGUE LOCK HOUSINGS

- 040186 CAMEC SQ ACCESS
 - 040187 ALL STORAGE
- Suits one key fits all system



ONE KEY RED ASSEMBLY KEY

- 041577 SUITS LOCKS BEFORE 2015
- 051826 SUITS LOCKS AFTER 2015



BUILDING SUPPLIES

Aluminium Cladding & Sheeting 263

Building Accessories 265

Plastic Mouldings 265

ALUMINIUM CLADDING & SHEETING



**ALUMINIUM CLADDING CP10 PROFILE
SMOOTH 250MM COVERAGE**

PART NO.	COLOUR	LENGTH
006764	SMOOTH WHITE	10.68M
040362	SMOOTH WHITE	8.0M
041527	SMOOTH WHITE	7.6M
038746	SMOOTH WHITE	7.3M
038415	SMOOTH WHITE	7.0M
038418	SMOOTH WHITE	6.5M
038748	SMOOTH WHITE	6.1M
038420	SMOOTH WHITE	5.5M
038940	SMOOTH WHITE	3.0M
040848	CRISTAL SILVER	10.68M
042327	CRISTAL SILVER	8.0M
042434	CRISTAL SILVER	7.3M
042759	CRISTAL SILVER	7.6M
043602	CRISTAL SILVER	7.0M
042761	CRISTAL SILVER	5.5M
043575	ONYX WHITE	10.68M
043582	DIAMOND SILVER	7.6M
044257	DIAMOND SILVER	7.0M



**ALUMINIUM CLADDING CP10 PROFILE -
STUCCO 250MM COVERAGE**

PART NO.	COLOUR	LENGTH
006768	STUCCO WHITE	10.68M
041528	STUCCO WHITE	7.6M
038416	STUCCO WHITE	7.0M
038421	STUCCO WHITE	5.5M
041446	CRISTAL SILVER	7.6M

ALUMINIUM CLADDING LP10 PROFILE

PART NO.	COLOUR	LENGTH
040363	SMOOTH WHITE	7.6M

**ALUMINIUM CLADDING NF10 PROFILE -
SMOOTH**

PART NO.	COLOUR	LENGTH
040914	SMOOTH WHITE	10.68M X 320MM
044624	SMOOTH WHITE	8.0M X 315MM
040114	SMOOTH WHITE	7.6M X 320MM
051516	SMOOTH WHITE	7.3M X 320MM
040113	SMOOTH WHITE	7.0M X 320MM
044585	CRISTAL SILVER	10.68M X 315MM
044614	CRISTAL SILVER	8.0M X 315MM
051089	CRISTAL SILVER	7.6M X 315MM
050237	CRISTAL SILVER	7.3M X 315MM
051546	CRISTAL SILVER	7.0M X 315MM
044654	DIAMOND SILVER	10.68M X 315MM
040118	STUCCO WHITE	7.6M X 320MM



ALUMINIUM CLADDING SF10 PROFILE - SMOOTH

PART NO.	COLOUR	LENGTH
006777	SMOOTH WHITE	10.68M
038931	SMOOTH WHITE	8.5M
038937	SMOOTH WHITE	8.0M
041525	SMOOTH WHITE	7.6M
038742	SMOOTH WHITE	7.3M
038406	SMOOTH WHITE	7.0M
038409	SMOOTH WHITE	6.5M
038744	SMOOTH WHITE	6.1M
038412	SMOOTH WHITE	5.5M
034757	SMOOTH WHITE	3.0M
040849	CRISTAL SILVER	10.68M
041799	CRISTAL SILVER	8.0M
042760	CRISTAL SILVER	7.6M
043948	CRISTAL SILVER	7.3M
041591	CRISTAL SILVER	7.0M
041681	CRISTAL SILVER	3.0M
044251	CRISTAL SILVER	2.4M
041039	DIAMOND SILVER (CONCEPT/FRANKLIN)	10.68M
042435	DIAMOND SILVER (CONCEPT/FRANKLIN)	7.6M
044256	DIAMOND SILVER (CONCEPT/FRANKLIN)	7.0M
043574	ONYX WHITE (CONCEPT/FRANKLIN)	10.668M
051300	ONYX WHITE (CONCEPT/FRANKLIN)	7.6M
044254	ONYX WHITE (CONCEPT/FRANKLIN)	7.0M
044253	ONYX WHITE (CONCEPT/FRANKLIN)	2.4M

STUCCO

PART NO.	COLOUR	LENGTH
051550	STUCCO WHITE	7.8M
041526	STUCCO WHITE	7.6M
038407	STUCCO WHITE	7.0M
038413	STUCCO WHITE	5.5M
041445	CRISTAL SILVER	10.68M
051549	CRISTAL SILVER	7.8M
041447	CRISTAL SILVER	7.6M
043949	CRISTAL SILVER	7.3M
042764	CRISTAL SILVER	5.5M



ALUMINIUM SHEETING CPF3 PROFILE

PART NO.	COLOUR	LENGTH
006961	SMOOTH WHITE	1220 X 2440MM
006999	STUCCO WHITE	1220 X 2440MM
043576	SMOOTH ONYX WHITE	1220 X 2440MM
040852	SMOOTH CRISTAL SILVER	1220 X 2440MM
041041	SMOOTH DIAMOND SILVER (CONCEPT/FRANKLIN)	1220 X 2440MM
041116	STUCCO DIAMOND SILVER (CONCEPT/FRANKLIN)	1220 X 2440MM
041443	STUCCO CRISTAL SILVER	1220 X 2440MM



ALUMINIUM CLADDING FLAT PROFILE

PART NO.	COLOUR	LENGTH
006806	SMOOTH WHITE	1220 X MTR
006920	SMOOTH WHITE	1220 X 2400MM
040851	SMOOTH CRISTAL SILVER	1220 X 2400MM
041040	SMOOTH DIAMOND SILVER	1220 X 2400MM
051387	JET BLACK	536 X 433MM
051384	JET BLACK	660 X 505MM
051385	JET BLACK	688 X 497MM
051386	JET BLACK	1090 X 536MM
006808	STUCCO WHITE	1220 X MTR
039711	STUCCO WHITE	1220 X 5000MM
041442	STUCCO CRISTAL SILVER	1220 X 2440MM



ALUMINIUM SHEETING CP48 PROFILE

PART NO.	COLOUR	LENGTH
006856	SMOOTH WHITE	1220 X 2400MM
040850	SMOOTH CRISTAL WHITE	1220 X 2400MM
006894	STUCCO WHITE	1220 X 2400MM
041441	STUCCO CRISTAL SILVER	1220 X 2400MM



ALUMINIUM COROMAL FR8

PART NO.	COLOUR	LENGTH
007045	POLAR GREY	1220 X 2440MM
040041	SMOOTH WHITE	8 X 4
043099	CRISTAL SILVER	1220 X 2440MM



ALUMINIUM COROMAL

PART NO.	COLOUR	LENGTH
050631	POLISH GREY	7.3M
035961	POLISH GREY	7.7M
050416	CRISTAL SILVER	6.5M
050632	CRISTAL SILVER	7.3M
043100	CRISTAL SILVER	7.7M
040042	SMOOTH WHITE	6.5M
050630	SMOOTH WHITE	7.3M
050419	CARBON FIBRE	6.5M
050633	CARBON FIBRE	7.3M
050418	CARBON FIBRE	7.3M

BUILDING ACCESSORIES



SPRAY PAINT BRIGHT WHITE
016772



SILICONE
007173 V4 NON ACETIC - WHITE
007174 V60 NON ACETIC - CLEAR
007175 V60 NON ACETIC - WHITE



FOAM TAPE

PART NO.	COLOUR	LENGTH
007284	BLACK	12MM X 6MM X 15M
007289	BLACK	6.4MM X 15MM X 15.2M
050219	BLACK	12MM X 3MM X 25M
050220	BLACK	12MM X 6MM X 15M
050221	BLACK	12MM X 12MM X 7M
007297	POLAR GREY	3MM X 12MM X 25M
007298	POLAR GREY	6MM X 12MM X 15M
007300	POLAR GREY	12MM X 12MM X 7M
007301	POLAR GREY	12MM X 24MM X 8M
035445	SELF ADHESIVE - GREY	24MM X 3MM X 25M
035457	SELF ADHESIVE - GREY	25MM X 9MM X 7M
035462	SELF ADHESIVE - GREY	18MM X 9MM X 7M
039922	SUITS 4 SEASON HATCH	22MM X 6MM X 2.7M

PAINT REPAIR

Camec aluminium paint codes are as follows:
FOR CLADDING AND PANELS, PAINT CODES ARE AS FOLLOWS:

WHITE	CARV1006
CAMEC ONYX WHITE	CARV9050
CRISTAL SILVER	CARV9001
DIAMOND SILVER	CARV9000

FOR FRAMES OR EXTRUSIONS, POWDER COAT CODES ARE AS FOLLOWS:

BRIGHT WHITE GLOSS	MA030A OR MA037A
BLACK SATIN	MN152A OR TN111A

Camec cladding paint colours are exclusive to Camec . To ensure the correct paint colour is matched, please refer to the colour codes listed above .
Paint codes not available in aerosol can .

PLASTIC MOULDINGS



WINDOW RADIUS MOULD X 3.6M
007308 WHITE
007309 BLACK



ANGLE
007313 10 X10 X4850MM WHITE
007314 25 X 25 X1.5MM X 3.6M WHITE
007316 12 X12 X 2440MM GT/BROWN
007318 EXT 12 X12 X 2440MM WHITE
007325 EXT 19 X19 X 3600MM WHITE



CAP MOULD TYPE C
007336 3-4MM X 4850MM WHITE
007340 20MM X 4850MM WHITE
007344 25MM X 4850MM TAN
007345 25MM X 4850MM WHITE

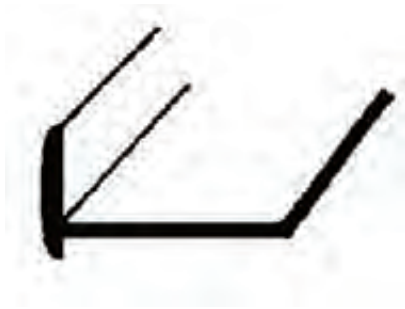

CEILING STRIP X 4850MM

007354 TAN
007355 WHITE



C/BOARD CORNER X 4850MM

007359 TAN
007360 WHITE



DOOR STEP MOULD X 4850MM BLACK

007361

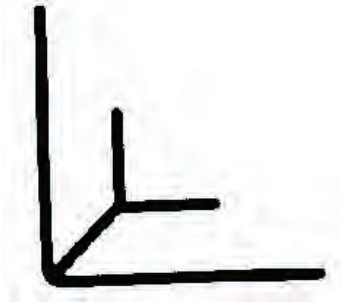

INTERNAL CORNER MOULD 2.4M

007369 WHITE
040149 SNOW WHITE



WINDOW MOULD

007383 25MM X 4850MM TAN
007384 25MM X 4850MM WHITE
007390 45MM X 4850MM WHITE



4MM H MOULD

007366 4MM X 4.85M WHITE
007397 4MM X 2.4M GT/BROWN
007398 4MM X 2.4M SILVER GREY
007399 4MM X 2.4M WHITE
039772 LONG LEG W/GRAIN



CAP MOULD TYPE L

007350 CAP WITH LEG 4MM X 4850MM WHITE
007403 3MM CAP MOULD 2.44M SILVER GREY
007404 3MM CAP MOULD 2.44M WHITE
007406 4MM CAP MOULD 2.40M GT BROWN
007408 4MM CAP MOULD 2.4M WHITE



32MM L MOULD 2.44M WHITE

007413



WEATHER SEAL-POP TOP EXTRUSION
007420

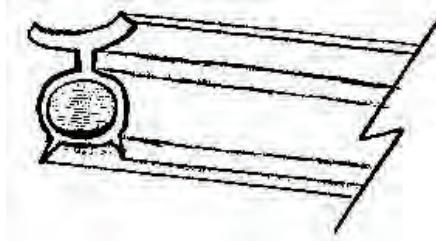

POP-TOP BUBBLE SEAL GREY
007421



ALI AMERICAN INFILL - PER METRE

- 007428 BROWN
- 007430 BEIGE
- 007432 GREY
- 007434 WHITE
- 007436 BLACK

Roll size is 250m



FENDERWELT X METRE (JOIN COVER)

- 007438 WHITE
- 007440 TAN
- 007446 APO-GRY
- 007479 KNOCK-IN MLD 20MM PER M WHITE

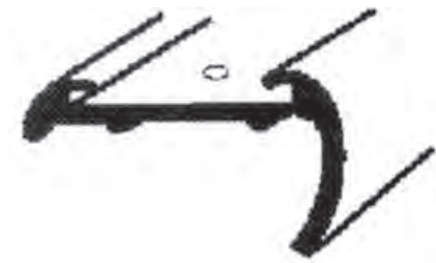

ALI AMERICAN MOULD X 5M

- 007127 WHITE
- 036684 BLACK
- 041761 CLEAR ANODISED



PINCHWELD PVC BL 100M ROLL

044917

Suit odyssey door window. Trim internal



ALI EDGEMLD 22 X 10.2MM X 5M MIL
007123



ALI P-TOP XTRUN X 6.5M
007137 WHITE



ALI BOTT P-TOP EXTN X 6.5M-WHT
007139

INDEX

A

Access Door	260
Accessory Plug	94
Aero Door	253
Air Conditioner	56
Alocholder	12, 13
Aluminium	
Cladding & Sheeting	263 - 264
Aluminium Step	7
Ampfibian	109
Anderson Plug	98
Annex Pole	20
Annex	38, 39
Pegs	20
Pole Container	20
Anode	182
Antenna	27, 28
Antenna Signal Meter	29
Anti Flap	40
Aqua Kem	173
Rinse	173
Auto Lights	81 - 88
Auto Wire	111
Awning	33 - 37
Rafter	41
Safety Straps	41
Spare Parts	41 - 51
Tension Rafter	40
Tie Down	41, 42
Bracket	41
Axles	113

B

Ball Weight Scale	135
Basin	207
Basin Mixer	209 - 212
Bathroom Cabinet	206
Battery	89 - 90
Box	89
Charger	112
Monitor	140
Switch	98
Bearings	114
Bike Racks	4, 5
Books	19
Boot Storage Doors	261
Breakaway System	140
Brake - Hydraulic	115
Arm	124
Controller	139
Magnets	115
Plates	115
Shoes	115
Spare Parts	125
Breaksafe	140
Bucket	18
Bug & Tar Remover	22
Bug Zapper	18
Bungy Cords	17

C

Cabin Hook	155
Cabinet	206
Camlock	153 - 154
Camp Forks	16
Camper Roof Lock	158
Trailer Cover	53
Canopy Lifter	159
Canopy Lifter - Springs	159
Canvas Cleaner	22
Tape	22
Caravan Covers	53
Movers	129
Carbon Monoxide Alarm	8
Catch - Cupboard	148 - 149
Ceiling Lights	102
Chock	2
Cigarette Lighter Plug	93
Socket	107
Circuit Breaker	93, 106
Cladding	263 - 264
Cleaner	22
Clock	11
Clothes Dryer	10
Clothesline	10
Coaxial Lead	30
Socket	30
Combination Lamp	83
Compressor	16
Copper Tube	217
Coupling	123 - 125
Cowl	170
Crockery Rack	8
Cupboard Stays	150
Catch	148
Curtain Hardware	156 - 157
Rod	156
Runner	156
Cutlery Tray	9

D

D Shackle	135
Damp Rid	11
Deflapper	40
Diaphragm Kit	204
Dish Drainer	8, 9
Door - Lock Spare Parts	257
Spare Parts	257
Blind	256
Handle	154
Handle - Camec	155
Lock	155
Stop	155
Access	260
Aero	253 - 254
Boot	261
MK1	255
MK2	255
MK6	255
Odyssey	245 - 248
Odyssey Premium	249 - 251
Vista	252
Down Light	102
Drier	78
Drop Shank	137
Drum	116
Drum Tap	14

E

Edge Mould	267
Egg Container	9
Electrical Leads	96
Storage Bag	96
Expanding Hose	16
External Lights	102 - 103
Extractor Fan	168
Extrusion	267

F

Fan	18
Faucet	210 - 212
Fiamma Awnings	33 - 39
Spare Parts	44 - 51
Fiamma Brackets	43 - 44
Fiamma Motors	42 - 43
Filter	215
Inline	197
Filtration Kit	215
Fire Blanket	8
Extinguisher	8
Extinguisher Holder	8
Box	8
First Aid Kit	8
Flask	13
Floor Matting	52
Fluro Lights	104
Fly Screens	238
Foam Tape	265
Fridge	57 - 73
Level	3
Spare Parts	74 - 75
Fuel Can	14
Drum	14
Fuse Blade	99
Fuse Box	99

G

Gas Compliance	216
Cylinders	221
Detector	216
Fittings	217 - 220
Hoses	222
Regulators	223
Struts	151
Generator	110
Glass Rack	9
Globes	100 - 101
12V	100
GPS Tracking	141
Grab Handle - LED	103
Replacement lens	104
Grease - bearing	114

H	
Hair Dryer	15
Halogen Globe	100
Hand Pump	209
Handles	150
Grab	150
Happy Hook	42
Hatch	260
Heater	18
Hinges	147
Cupboard	147
Hitch Cover	138
Pin Lock	137
Step	135
Holding Tank	180
Accessories	180
Hook - Bathroom	206
Cabin	155
Fittings	189
Hose - Sullage	190 - 191
Water	190 - 191
Bag	190
Connector	196 - 197
Gas	222
Shower	213
Hot Water System	181
Spare parts	182
Hubs	116
I	
Interior Lights	102 - 105
Inline Filter	215
J	
Jerry Can	14
Holders	14
Jockey Wheels	118
Off Road	120
Spare Parts	121
Jupiter Windows	233
K	
Keyless Entry	258
L	
Ladder	6
Lamp - Marker	81, 84, 85
Trailer	87
Combination	86
Latch - Compress	149
Stream	149
LED Auto Lights	84 - 88
Globes	99 - 101
Handle Light	105
Interior Light	102
Leg Drop Down	121
Leg Support Plates	3
Level	3
Levelling Ramps	2, 3
Licence Plate Lights	81 - 83
Light Board	83
Fluro	104
Interior	102 - 103
Lock - Hitch Pin	130
Wheel	131
Coupling	130
Trailer	130 - 131
LPG Compliance Plate	216
M	
Magnesium Rod	182
Marker Lights	84
Mast	29
Matting	52
Mattress	142
Microwave	76
Midge Insect Screen	161, 238
Miracle Grip	9
Motorhome Covers	54
Mud Guard	117
Mugs	13, 15
N	
Non Slip Mat	8
Number Plate Lights	81
Nut and Tail	197 - 198
O	
One Key System	152, 262
Overtake Sticker	132
P	
Paint Repair	265
Pantry Basket	151
Pedestal Leg	144
Peg - Annex	20
Tent	20
Picnic Tables	259
Plastic Mouldings	265 - 267
Step	7
Plate Retainer	9
Stacker	9
Plug - Accessory	94 - 96
Cigarette	107
Trailer	94 - 96
Sink	208
Tank	188
Plumbing Fittings	194 - 201
Pocket Torch	17
Pop Top Support	158
Cover	53
Pop Up	9
Portable Shower	15
Steps	7
Pots	11
Power Adaptor	109
Inlet	108
Mover	119
Outlet	108
Point	97
Privacy Room	38, 39
Screen	38, 52
Screen Pegs	52
Pull Pin	130, 136
Pumps	200 - 203
Inline	205
Spare Parts	204
Push Rod - Camper	159

R	
R Clips	137
Rack - Crockery	9
Rangehood	77
Ratchet Tie Down	21
Reading Lamp	106
Reading Light	105
Reducer	192, 195, 198
Reflectors	81
Refrigerators	57 - 73
Spare Parts	74 - 75
Regulator - Solar	92
Remote Control	25
Repair Tape	22
Rollout Pantry	151
Roof Hatch	160 - 166
Roof Hatch - Spare Parts	161, 166 - 168
Roof Rail	40
Curved	40
Roof Vent	162 - 163
Spare Parts	164 - 165
Room Divider	157
Rope Track	41
S	
Sash Frames	236
Saucepan	11
Screen Mesh	242
Seal	267
Security Handle	154
Sender Probe	183
Service Door	255
Shade - Drip Mold	241
Hold Down Catch	241
Stay	241
Sheeting	263 - 264
Shin Protector	132
Shock Absorbers	127
Shock Cord	17
Shovel	16
Shower	213 - 214
Tray	206
Side Mark Lights	81
Silicone	265
Sink	207
Mixer	209 - 212
Plug	208
Smart Space Pots	11
Smoke Alarm	8
Soap Dispenser	206
Dish	206
Socket Cigarette	107
Trailer	94 - 96
Solar Panels	91
Cables	92
Junction Box	92
Regulator	92
Speakers	31
Spray Paint	265
Springs	126
Spare Parts	126
Stab Pads	3
Stabilisers	3
Steady Drop Down	121
Steps	7
Light	105
Stool	16
Storage Pocket	9
Stove	77
Striker	148
Super Suction	206
Sway Control	136
Switch	96, 106

T	
Table	15
Legs	143 - 146
Picnic	259
Tank - Water	185-186
Brackets	186
Clean	183
Gauge	183
Fittings	187
Roll	180
Tap	188
Tap - Hand pump	209 - 212
Mixer	209 - 212
Jerry Can	14
Water Tank	188
Tape Canvas Repair	22
Gas	217
Tapware	209 - 212
Television	23, 24
Tent Pegs	20
Pole	20
Pole Container	20
Tie Down	21, 40
Toggle Switch	96
Toilet - Cassette	176
Portable	175
Fittings	178 - 179
Spare Parts	177 - 178
Consumables	173 - 174
Paper	173
Tow aid	138
Towball	131 - 132, 137
Tow Ball Adaptor	136
Cover	132
Towel Rail	153, 206
Towing Kit	137 - 138
Towing Mirrors	133
Coppa Rossa	133
Ora	133
Camec	133
Trail A Mate	119
Trailer Lights	87 - 88
Plug	94 - 96
Valet	129
Travel Books	19
Mug	12, 13, 15
Tumblers	12, 13
TV	23 - 24
Antenna	27, 28, 31
Antenna Signal Meter	29
Bracket	26
Fly Lead	29
Plug pack	25
Power Adaptor	25
Remote	25
Smart Remote	25
Wall Connections	28
Tyre	117
Tyre Saver	2
U	
U bolt	127
Union	188, 196, 201, 203, 212, 218, 219
Utility Table	15
USB Ports	98
Socket	107
V	
Van Plug	95
Vehicle Step	128
Vents - Aluminium	169
Exhaust	168
Plastic	168 - 169
Rotary	169
Scupper	170
Spare Parts	170
Vin Plates	123
Vista Door	252
Vitrifrigo Fridges	57 - 72
Voltage Relay	93
Voltmeter	106, 107
W	
Washing Machines	78
Spare Parts	79-80
Waste Kit	208
Waste Outlet	208
Deodoriser	174
Water Fillers	191 - 192
Water Filter	215
Water Monitor	183
Water Hose	190 - 191
Water Tanks	185 - 186
Tank Fittings	187 - 188
Tank Gauge	183 - 184
Tank Probe	183
Water Treatment	215
Weight Distribution	135 - 136
Weight Scale	135
Wheels	117
Arch	117
Alloy	117
Chock	2
Level	2
Lock	131
Winch	130
Window Boxes	239
Blinds	243
Spare Parts	239 - 242
Jupiter	233
MK2	235
Odyssey	225
Odyssey Plus	228
Odyssey Premium	231
Sash	236 - 237, 240
Slimline Slider	234
Wine Cups	13
Wineglass Table	144
Wireless Charger	112
Wiring	111
WITI	131, 141

Disclaimer:

At the time of publication the information contained in this catalogue was and is correct. However, products contained in the catalogue are subject to being made discontinued or may change without notice. Camec recommends prospective purchasers establish that the product is suitable for their needs before making any purchase. Products are made to a specification and due to varying manufacturing methods and variances in material, may be subject to change without notification. Images contained in the catalogue are used for illustration purposes only. Images may not always be representative of the actual product listed due to changes in specifications or general illustration representation. All specifications and sizes have been listed with intention of being correct at the time of printing. Camec recommends that all purchasers establish whether the product is fit for purpose prior to purchase. Camec reserves the right to delete, update, modify or make additions to any product contained or displayed within the catalogue without prior consent or notification. The publication is subject to copyright and may not be displayed or reproduced without prior authorisation by Camec Pty Ltd or Fleetwood Corporation. Other than for the purpose of and subject to the conditions prescribed under the copyright act, no part of it may be in any form or by any means (electronic or mechanical) reproduced, stored in a retrieval system or transmitted without the permission of Camec Pty Ltd or Fleetwood Corporation. ABN 35 004 846 584.

FREEZE YOUR MOMENTS



MAKE EVERY SPECIAL MOMENT UNIQUE.

INNOVATION, DESIGN AND ECO-SUSTAINABILITY: this is the fundamental core of vitrifrigo and is part of a broader corporate strategy aimed at respecting environmental obligations.

We have developed a policy to continue our commitment to operate as a responsible company. This covers every aspect of the Company's activities, whether directly or indirectly involved in the design, engineering, manufacturing, maintenance of our products, or distribution of their parts.

In line with this policy, vitrifrigo has invested multiple resources to Renew the ranges of products with low GWP and natural gas solutions.

MADE IN ITALY



VITRIFRIGO
COOL AND BEYOND

**REFRIGERATORS AND FREEZERS
FOR RECREATIONAL VEHICLES**

VAG
VITRI ALCESTE GROUP

www.vitrifrigo.com



For all trade & retail enquiries contact:

National Customer Service

Phone 1300 4 CAMEC (1300 422 632)
Fax 03 9799 6488
Email camec@camec.com.au

Victoria

47-63 Remington Drive
Dandenong South VIC 3175

23-27 Freight Drive
Somerton VIC 3062
P 1300 422 632

New South Wales

Unit 2 & 3, No. 1 Koonya Circuit
Caringbah NSW 2229
P 02 9525 2588

Queensland

Building 3, Archerfield Industrial
Park Cnr Kerry & Beaudesert Rd,
Archerfield QLD 4108
P 07 3710 9000

Western Australia

190 Welshpool Road
Welshpool WA 6106
P 08 9351 0044