



Coast to Coast

2023 CATALOGUE



Your Caravan Store with MORE !!

ETOURER M-SERIES



See More on Page 100

Powerful, quiet and perfectly integrated - these are the attributes of the M-Series.



CONTENTS

1

AIR CONDITIONERS (Product Group - 100)

| | |
|---------|-----------|
| Dometic | 004 - 006 |
| Truma | 005 - 007 |
| Heating | 007 - 008 |

PRIVACY ROOMS (Product Group - 150)

| | |
|------------------------|-----------|
| Fiamma | 009 - 011 |
| Coast Awning Wall Kits | 012 |
| Orbit Annexes | 013 |

AWNINGS & ACCESSORIES (Product Group - 200)

| | |
|----------------------------------|-----------|
| Fiamma Awnings | 014 - 020 |
| Fiamma Adapter Brackets | 020 - 022 |
| Awning Accessories | 022 - 026 |
| Floor Matting | 028 - 030 |
| Sunscreens | 031 - 035 |
| Carefree Awnings and Accessories | 036 - 046 |

BUILDING MATERIALS (Product Group - 250)

| | |
|-------------------------------------|-----------|
| Stabilus Gas Struts | 047 |
| Caravan Bed Frames | 048 |
| Canopy Lift Mechanisms | 049 |
| Pop Top & Camper Parts | 049 - 050 |
| Aluminium Extrusion & Mould Infills | 051 - 052 |
| Aluminium Cladding | 053 |
| Tape Foam | 053 |
| Lippert Slide Out Rooms | 054 - 055 |

2

CAMPING EQUIPMENT (Product Group - 300)

| | |
|--|-----------|
| Camping Accessories | 060 - 063 |
| Coast Fire Pits | 064 |
| Collapsible Homeware | 065 |
| Palm Drinkware and Kitchen Accessories | 066 - 070 |

CAR ACCESSORIES (Product Group - 350)

| | |
|------------------------------|-----------|
| Towing Accessories | 070 - 074 |
| Towing Mirrors | 074 - 076 |
| Brake Controllers | 077 - 079 |
| CURT Towing Accessories | 079 - 082 |
| Tyre Pressure Monitoring | 083 |
| Lippert Swap Command Kit | 084 |
| Quick Fit Bike Racks | 085 - 086 |
| Carry Bikes and Accessories | 087 - 090 |
| Hayman Reese Hitches | 091 - 092 |
| Eaz Lift WDH and Accessories | 093 - 096 |
| Tips For Safer Towing | 097 - 098 |
| Throttle Controllers | 100 |

3

CARAVAN ACCESSORIES (Product Group - 400)

| | |
|--------------------------------|-----------|
| Dinnerware | 104 - 105 |
| Caravan Accessories | 106 - 110 |
| First Aid | 110 |
| Table Legs and Components | 111 - 113 |
| Picnic Tables | 114 - 116 |
| Roof Racks and Accessories | 117 - 118 |
| Security Handles | 118 - 119 |
| ADCO RV Covers and Tyre Guards | 120 - 122 |
| Cleaning Products | 122 - 123 |

CHASSIS EQUIPMENT (Product Group - 450)

| | |
|-------------------------------------|-----------|
| Trail-A-Mate | 123 - 124 |
| Jacks and Levels | 124 - 128 |
| Jockey Wheels and Accessories | 128 - 131 |
| Trailer Locks | 131 - 132 |
| Steps | 132 - 134 |
| Wheel Spats | 135 |
| Hub Kits and Accessories | 135 - 137 |
| Bearings and Seals | 137 - 139 |
| Level Indicators | 140 |
| Heavy Duty Couplings | 141 |
| Shackles and Couplings | 142 - 143 |
| Corner Steadies | 143 - 144 |
| Shackle Pins and Nuts | 144 - 145 |
| Tow Ball Scales and Weight Controls | 145 |
| Purpleline Levellers and Security | 146 - 148 |
| Milenco Levellers | 149 |
| Stone Shields | 150 - 151 |

4

ELECTRICAL EQUIPMENT (Product Group - 500)

| | |
|----------------------------------|----------------------|
| Fans and Smoke Alarms | 156 |
| Battery & Accessories | 157 - 159 |
| Narva Electrical Fittings | 171 - 175 |
| Power Inlets and Outlets | 175 - 177, 181 - 182 |
| Power Points & Switches | 176 - 182 |
| Electrical Leads | 179 - 180 |
| CMS Equipment | 180 - 182 |
| 15amp-10amp Adaptors | 182 - 183 |
| NARVA Accessory Sockets | 183 - 184 |
| Solar Panels | 185 - 186 |
| Tyre Inflators (Air Compressors) | 186 - 187 |
| Trailer Plugs and Sockets | 187 - 189 |
| Auto Cable | 189 - 194 |
| Caframo Fans | 195 - 196 |
| Briggs and Stratton Generators | 197 |

5

LIGHTING EQUIPMENT (Product Group - 500)

| | |
|----------------------------|-----------|
| Lights and Lenses | 160 - 162 |
| Truck and Trailer Lighting | 163 - 165 |
| LEDs | 166 - 167 |
| Reflectors | 168 |
| Sphere™ Wireless Lighting | 169 - 170 |

GAS EQUIPMENT (Product Group - 550)

| | |
|-----------------------------|-----------|
| Gas Regulators and Hoses | 198 - 201 |
| Gas Unions, Nuts and Valves | 201 - 203 |
| Gas Cylinders and Cradles | 198 |
| Gas Detector | 198 |

CARAVAN HARDWARE (Product Group - 600)

| | |
|--|-----------|
| Coast Access Doors | 208 - 210 |
| Grab Handles and Cabin Hooks | 210 - 212 |
| Thetford Service Doors | 212 - 213 |
| Rosettes, Nickels and Door Locks | 213 - 214 |
| Valterra Access Hatches | 215 |
| Window Parts | 215 - 216 |
| DGN Hinges | 216 |
| Caravan Cleaners, Touch Up Paint and Sealers | 217 - 221 |

HATCHES & VENTS (Product Group - 650)

| | |
|--|-----------|
| Elixir Mini Vent | 222 |
| Ventline Vents and Spares | 222 - 223 |
| Unimaxx Replacement Vent Lids | 223 |
| Four Seasons Hatch and Spares | 223 - 224 |
| Fantastic Vents and Spares | 224 |
| Dust Reduction System | 224 |
| Fiamma Hatches, Vents and Hatch Spares | 225 - 226 |
| MaxxAir Ventilation | 226 - 227 |
| Skymaxx Ventilation | 228 - 229 |
| Exterior, Rotary and Scupper Vents | 229 - 230 |

6

MAJOR APPLIANCES (Product Group - 700)

| | |
|---------------------------------------|-----------|
| Rangehoods | 234 |
| Washing Machines and Spare Parts | 235 - 237 |
| Fridge Fans | 238 |
| Waecco Refrigeration | 239 - 240 |
| Dometic Refrigeration and Accessories | 240 - 242 |
| Thetford Refrigeration | 243 - 245 |
| Thetford Cooking Appliances | 246 - 250 |
| Dometic Cooking Appliances | 251 |
| Lido Stoves | 251 |
| Barbeques | 252 - 253 |
| Sphere Microwave | 253 |
| My Coolman Fridges | 254 - 255 |

7

PLUMBING (Product Group - 800)

| | |
|--|-----------|
| Shurflo Pumps and Parts | 261 - 266 |
| Lockable Water Fillers | 266 - 267 |
| Waste Hose and Drinking Hose | 268 - 269 |
| Water Tanks | 270 - 272 |
| JG Plumbing Fittings | 272 - 277 |
| Plastic Plumbing Fittings | 277 - 280 |
| Fuel Safe Cans | 281 |
| Accumulator Tanks | 281 |
| Tank Cleaners | 281 - 282 |
| Thetford Sinks, Smev Sinks and Ceramic Sinks | 282 - 285 |
| Shower Hoses, Mixers and Hand Pumps | 285 - 287 |
| Faucets | 287 - 288 |

TOILETS (Product Group - 850)

| | |
|---|-----------|
| Fiamma Bipots and Thetford Porta Pottis | 289 - 290 |
| Thetford Additives Cleaners | 291 - 293 |
| Toilet Tissue | 294 |
| Thetford Cassette Toilets | 295 - 296 |
| Thetford Toilet Accessories and Spares | 296 - 298 |
| Valterra Hoses, Valves and Fittings | 298 - 299 |
| Camco Sewer Fittings and Hoses | 299 - 301 |
| Fiamma Waste Tanks | 301 |
| Caravan Loo Treatment | 302 |
| Toilet Deodorisers | 302 - 303 |

8

TV EQUIPMENT (Product Group - 900)

| | |
|-----------------------------------|-----------|
| Winegard Antenna and Spares | 307 - 310 |
| Antennatek Spare Parts | 311 - 312 |
| Foldaway Antenna and Accessories | 312 |
| Happy Wanderer Antenna and Spares | 313 |
| Signal Boosters | 313 |
| Furion Visions | 314 |
| Reversing Cameras | 314 - 317 |
| Sphere™ Entertainment | 318 - 320 |
| Sphere™ Cables and TV Fittings | 321 - 322 |
| Sphere™ Satellite | 324 - 325 |
| Sphere Wifi Routers | 326 |
| Fusion Entertainment | 327 |
| Furion Audio/Visual Entertainment | 328 - 330 |
| Rokk Tablet Mount | 331 |

WATER HEATERS (Product Group - 950)

| | |
|---------------------------------------|-----------|
| Suburban HWS Range | 332 - 335 |
| HWS Maintenance Accessories | 336 - 338 |
| Suburban Nautilus HWS and Accessories | 339 - 342 |

**SPHERE
TWIN
CELL
SOLAR
PANEL**

Sphere Twin Cell Solar Technology is the future of solar power generation



See More on Page 185

Twin Cell Technology vs Standard Cell Panels

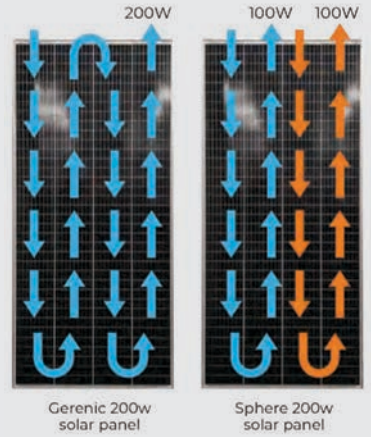

**MAXXFAN
DELUXE
WITH
SMOKE LID**

Maxxfan Deluxe now available with an extra strong polycarbonate smoke lid!



See More on Page 227

**THETFORD
SEAL
LUBRICANT**

200ml Aerosol Spray that thoroughly lubricates and protects toilet seals.



See More on Page 292

SECTION 1

AIR CONDITIONERS

(Product Group - 100)

| | |
|---------|-----------|
| Dometic | 004 - 006 |
| Truma | 005 - 007 |
| Heating | 007 - 008 |

PRIVACY ROOMS

(Product Group - 150)

| | |
|------------------------|-----------|
| Fiamma | 009 - 011 |
| Coast Awning Wall Kits | 012 |
| Orbit Annexes | 013 |

AWNINGS & ACCESSORIES

(Product Group - 200)

| | |
|----------------------------------|-----------|
| Fiamma Awnings | 014 - 020 |
| Fiamma Adapter Brackets | 020 - 022 |
| Awning Accessories | 022 - 026 |
| Floor Matting | 028 - 030 |
| Sunscreens | 031 - 035 |
| Carefree Awnings and Accessories | 036 - 046 |

BUILDING MATERIALS

(Product Group - 250)

| | |
|-------------------------------------|-----------|
| Stabilus Gas Struts | 047 |
| Caravan Bed Frames | 048 |
| Canopy Lift Mechanisms | 049 |
| Pop Top & Camper Parts | 049 - 050 |
| Aluminium Extrusion & Mould Infills | 051 - 052 |
| Aluminium Cladding | 053 |
| Tape Foam | 053 |
| Lippert Slide Out Rooms | 054 - 055 |



100-00007
COAST H40 -
AIRCONDITIONER
ALUMINIUM ROOF
MOUNT H FRAME

SPECIFICATIONS

400 x 405mm Fit



100-00008
COAST H36 -
AIRCONDITIONER
ALUMINIUM ROOF
MOUNT H FRAME
- 361 X 365MM FITD

SPECIFICATIONS

361 x 365mm Fit



100-00082
UNIVERSAL AIR
CONDITIONER GASKET KIT

Acts as a seal between your air conditioner and your roof to limit rain from entering where the air conditioner has been installed. The kit includes a self adhesive square gasket [356L x 356W (mm)] and x2 self adhesive levelling pads.



100-00400
DOMETIC IBIS 4 LOW
PROFILE ROOF TOP
AIR CONDITIONER (INC.
PLENUM 2 PART PICK)

The Dometic IBIS 4 sets a new standard for air conditioning in the mobile living market thanks to several refinements made from the acclaimed IBIS 3. The Dometic IBIS 4 features a powerful dual-cylinder horizontal compressor, a first for the RV industry, which creates a more balanced roof top unit and reduces the level of vibration.



FEATURES

- > Excellent cooling capacity of 2.6kW
- > Dimensions: 758 x 230 x 1112mm
- > Extremely quiet cooling, even at maximum speed
- > Adjustable vents for even air distribution
- > Lightweight rooftop unit at only 40kg
- > Four fan speeds, including a turbo speed
- > Suitable for both 400 x 400mm and 360 x 360mm roof openings

SPECIFICATIONS

Rooftop Dimensions (W x H x D): 758 x 230 x 1112mm
 ADB Dimensions (W x H x D): 518 x 48 x 579mm
 Installed Weight: 40kg
 Compressor Type: New Generation Variable Speed
 Cooling Capacity: 2625W
 Current Draw (Cooling): 6.9A
 Start-up Current: 7.5A Maximum
 Maximum Current Draw: 8A Maximum
 Fan Speeds 4: (including Turbo speed)
 Roof Opening Fitment: 400 x 400mm or 360 x 360mm

100-00450 DOMETIC HARRIER LITE ROOF TOP AIR CONDITIONER (INCL PLENUM 2PART PICK

The Dometic Harrier Lite is Dometic's latest innovation in air conditioning and has been specially designed to fit small to medium-sized caravans, pop-tops, and campers. Dometic has struck a balance between utilising a lightweight, compact design, and an impressive heating and cooling performance. It comes featured with cool, white LED lights, and the dual-cylinder inverter compressor that the market has come to know through the highly sought-after IBIS 4.



Dual-Cylinder Inverter Compressor

The Dometic Harrier Lite features an innovative dual-cylinder inverter compressor and its patented design minimises vibration and provides improved performance over conventional compressors. It's this kind of smart design that puts the Harrier Lite in a league of its own and allows RV goers to enjoy cool and fresh air at the touch of a button.

FEATURES

- > Easy Control
- > LED Lights
- > Lightweight
- > Dual-cylinder inverter compressor reduces vibration and is highly efficient
- > Low fan noise with three standard speeds
- > Cool white LED lights in the ADB which can be activated via the remote control
- > Adjustable outlet vents with individual vertically adjustable airflow
- > Connectivity with CI-BUS compatible control panels
- > Lightweight for a low centre of gravity
- > Low profile rooftop unit

SPECIFICATIONS

Dimensions Product Depth: 997mm
 Dimensions Product Height: 240mm
 Dimensions Product Width: 665mm
 Net Weight: 37kg
 Input Voltage (AC): 220-240V
 Cooling Capacity (ISO 5151): 2413W
 Heating Capacity (ISO 5151): 2421W

100-02090 TRUMA SAPHIR REVERSE CYCLE AIR CON. SAPHIR R/C- KIT

Had enough of balmy days and chilly nights camping out in the van, well it might be the right time to get reverse cycle air-conditioner to make your stay comfortable no matter where or when you camp in this great country and if you don't want any more weight or height on your roof but still want the powerful cooling or the cosy ambient warmth that a roof top A/C offers then the Truma Saphir may be your best friend with a big 2400 watts of cool air & toasty 1700 watts of warmth all effortlessly supplied from a self-contained unit that is even small enough to fit under your bed or the cupboard, all you'll need to do is connect up some ducting to any of the three included outlets and you'll be able to send enough air anywhere you want it in your van for maximum coverage and comfort.



Being a small unit the Saphir air-conditioner it isn't exactly small on features thou as Truma have packed it with everything you need and nothing you don't such as

FEATURES

- > Remote Controlled Operation
- > Automatic Heating & Cooling Function
- > 3 Speed Blower with Sleep Mode
- > 3 Outlets Included for Maximum Coverage
- > Will Run off a 2 kVA Generator*
- > Handles Vans up to 6.5m
- > Ultra-Light Weight at 23.5 Kg & Smallest Sized in its Class
- > Low Mount Installation Provides Lower Centre of Gravity for Your Van Aiding Stability
- > Smart Timer Function - Will Allow a Generous Cooling Time of Up to 15 Hours That Can be Programmed in Advance
- > Pollen Filter to Provide Relief for Allergy Sufferers
- > Closed Refrigeration Circuit Design Provide Maintenance-Free Operation

* Premium brand generators use only that have genuine 2Kva & above specifications

SPECIFICATIONS

Cooling Capacity: 2.4 kW
 Heating Capacity: 1.7 kW
 Power: 240V
 Max Airflow: 380 m³/h or 105 L/s
 Dimensions: 628 mm x 400 mm 290 mm
 Weight: 23.5kg
 Ducting Required: 60mm ID
 Operating Temperature Range: 4°C to 43°C
 Warranty: 12 Months

100-02100**TRUMA AVENTA COMFORT
REVERSE CYCLE AIR
CONDITIONER**

The new Truma Aventa is quite powerful with a surprisingly slim and attractive plenum. It offers 1700W of heating power and a powerful 2400W of cooling capability. Its energy saving heat pump ensures a comfortable temperature inside your RV (provided the outside temperature is greater than 40°C), and it provides dehumidified, cleaned air thanks to its air filter system.



NOT
AVAILABLE IN
NEW ZEALAND

The Truma Aventa cools the inside of your RV quickly and quietly. Its flexible air distribution system allows you to direct the air where it is mostly needed, thus cooling efficiently. It even has a sleep mode function; if this is selected, the evaporator and condenser fans will run slower, resulting in even quieter operation for a restful sleep. The plenum has LED lighting which can be dimmed if ambience is required. It is suitable for RVs up to 7.5m in external length and comes with a remote control with a programmable timer function. Dometic offers a 2 year warranty on the Truma Aventa Comfort.

SPECIFICATIONS

Electrical Rating (single phase): 240V, 50Hz

Nominal Cooling Capacity: 2.4kW

Nominal Heating Capacity: 1.7kW

Max Rated Current - Cooling: 4.2A

Max Rated Current - Heating: 3.7A

Max Air Delivery: 400m³/hour

Installed Weight: 33kg

Dimensions: 248H x 523W x 1008L (mm)

Air Dimensions: 46H x 670W x 523L (mm)

Operating Temperature Range: +4°C to +40°C

100-00461**DOMETIC HARRIER
PLUS ROOF-TOP AIR
CONDITIONER. (INCL
PLENUM 2 PART PICK)**

The Dometic Harrier Plus is a rooftop RV air conditioner that is efficient, powerful and quiet. It uses the advanced technology of a dual-cylinder inverter compressor that is smoother and quieter when operating and has a powerful cooling capacity. Featuring a lightweight design and low profile, the Harrier Plus will impress with its functionality, output, cooling and heating. The innovative dual-cylinder inverter compressor has a patented design that helps reduce vibration and provides improved performance over conventional compressors. It's the kind of smart design that puts Dometic air-conditioners in a league of their own and allows RV owners to enjoy cool and refreshing air at the touch of a button.

**FEATURES**

- > Cooling capacity of 3.0 kW
- > Dual cylinder inverter compressor means lower energy consumption, noise and vibration
- > 4-speed fan including Turbo mode for rapid cooling or heating
- > Low profile ADB with optimised airflow
- > Lightweight at 44 kg
- > Wide operating temperature range of - 2°C to + 52°C
- > Fitment to both 360 and 400 mm roof opening sizes possible

DIMENSIONS

Depth: 1070 mm

Height: 280 mm

Width: 750 mm

Net weight 44 kg

Electrical

Input voltage (AC): 220-240 V

Input frequency: 50 Hz

Performance

Cooling capacity (ISO 5151): 3028 W

Heating capacity (ISO 5151): 3017 W

Power consumption - Cooling mode (ISO 5151): 1587 W

Power consumption - Heat pump (ISO 5151) - Display: 1357 W

TRUMA AIR HEATING SYSTEM

The new compact Truma heater for motorhomes, caravans and vans.

The Truma VarioHeat eco is an extremely compact and lightweight heater of the latest generation. It is very powerful and heats your vehicle to the required temperature very quickly. Thanks to the various functions, you can always set the heater to your precise requirements.

FEATURES

- > Powerful caravan heater with two outputs levels
- > Automatic regulation of the heating output depending on the set temperature
- > Lightweight, requires little space
- > Even heat distribution in the vehicle via air outlets
- > Exact setting of the requires room temperature
- > High air throughput for very quick heating

100-02130

TRUMA VARIOHEAT GAS AIR HEATING SYSTEM - VARIOHEAT - KIT

Includes a basis air kit and is a complete single outlet unit. Includes Cream Cowl.



100-02140

TRUMA VARIOHEAT GAS AIR HEATING SYSTEM VARIOHEAT - KIT - BLK

Includes Black Cowl

100-02136

TRUMA VARIOHEAT ADDITIONAL SET WARM AIR

If a second outlet is required an additional ducting set can be purchased. A Truma VarioHeat with two outlets will consist of 100-02130 + 100-02136

100-02062

DOMETIC DUCTING T/S SAPHIR AND CLIMASTER - 15M

100-02063

TRUMA DUCTING T/S SAPHIR & CLIMASTER 5M LENGTH

100-02064

DOMETIC DIESEL HEATER DUCTING 60MM T/S D2 - HEATER SOLD PER METRE



100-02400

EBERSPACHER AIRTRONIC 12V DIESEL HEATER

Offering automatic room temperature control, the energy efficient Airtronic Diesel Heaters allow you to set and forget. You simply need to program in a desired temperature and the heater will deliver hot blown air until the desired temperature has been reached. Thanks to their low fuel consumption, they're a great option for those of us who need to run them for long periods of time. Available in both single and twin outlet models, they're a great companion for life on the road.



FEATURES

- > Fully electronic microprocessor control
- > Continuous monitoring
- > Power stage to cut heating times
- > Smooth automatic room temperature control with a temperature pre-set facility
- > Low fuel and power consumption, suitable for longer periods of operation
- > More comfort thanks to wide control range and quiet night-time operation
- > Diagnostic system

DIMENSIONS

Depth: 310 mm
 Height: 122 mm
 Width: 115 mm
 Net weight 2.7 kg
 Electrical
 Input voltage (AC): 12 V
 Performance
 Fuel type: Diesel
 Fuel consumption peak: 0.28 l/h

100-02058

EBERSPACHER DIESEL HEATER BLACK 10L FUEL TANK

A slimline storage canister that holds up to 10L of diesel to run your Dometic heater. It has three bolting points to avoid spillage.



AUTOTERM AIR HEATERS

Autoterm air heaters are designed to provide warm air to living areas of vehicles and buses, as well as to cars, motorhomes, campers, in housing and cabins of yachts and ships in the cold seasons. quietest heaters in the market.

**FEATURES**

- > Silent pump. The Autoterm manufactured fuel dosing pump reduces noise output by 95% - perfect for the lightest sleepers.
- > Brushless fan motor. No one else is using this technology that provides much more torque and longer lifetime of the motor.
- > Stepless fan speed. All other heaters use fixed fans speed steps, but Autoterm computer algorithm can precisely choose the fan speed required to achieve the best heater temperature response, which maintains room temperature more accurately and allows more efficiency from the heater.
- > Balanced fan. Each heater fan assembly is run on a balancing machine, the balancing prevents noise and vibration from the heater even at its max speed of 4500rpm. Prevents premature wear of the heater.
- > Air intake silencer included. This is a genuine silencer that helps make Autoterm heaters the quietest heaters in the market.
- > Operation at -40 degrees. These heaters are built not to fail. They are relied on all over the world to provide heat in extreme weather conditions.

100-02502**AUTOTERM DIESEL AIR HEATER 12VOLT 2KW KIT WITH ROTARY CONTROLLER**

The PU-5 Rotary Controller is very easy to operate and install. Simply turn the heater on and adjust the fan speed/heat output with the rotary knob.

**100-02504****AUTOTERM DIESEL AIR HEATER 12VOLT 2KW KIT WITH DIGITAL CONTROLLER**

The PU-27 Digital Controller is the recommended controller for most people as once you have it set up, you simply press one button and adjust the temperature up or down. It also has other functions the Rotary Controller does not such as multi day timers.

**SPECIFICATIONS**

Fuel: Diesel
 Fuel Consumption: 0.1-0.24 L/h
 Hot Air Flow: 34-75 m3/h
 Set Weight: 6.5kg
 Power Consumption: Min 10W to max 29W
 Stepless DC Induction Motor
 Made in Europe

100-02510**DIESEL HEATER LOCKABLE FUEL TANK - BLACK - 10L (390X390MM)**

FIAMMA PRIVACY ROOMS



Classic enclosure suitable for all seasons, the best solution for medium and long term stays.

BENEFITS AT A GLANCE

- > Quick installation in 15 minutes with Fast Clip poles
- > Ideal for all seasons
- > Composed of one front panel and two side panels
- > All Crystal full light windows that can be rolled up, with Mosquito net and curtains as standard
- > 3 heights are available: Van [S], Medium [M], Large [L]
- > Standard pegs for safe anchoring
- > Complete with Mega Bag to store Privacy Room and poles.

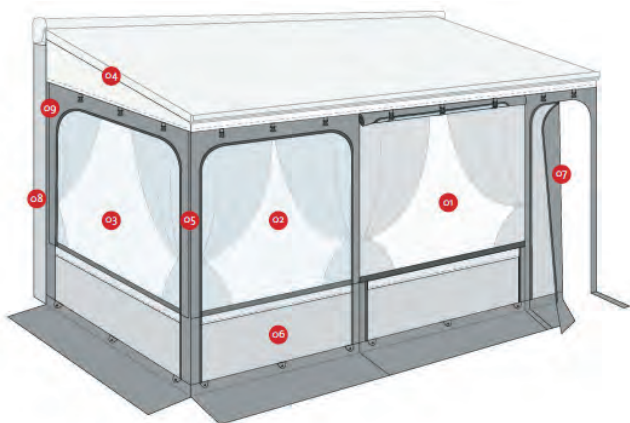

1. Panels

With roll-up Crystal full light window, fitted with mosquito net and curtains as standard

2. Additional front panels

With fixed Crystal full light window and curtains as standard equipment

3. Windows

Equipped with a thick velcro strip for a safe closing of the window

4. Fast Clip

For quick and safe hooking to the awning fabric with internal lever hooks

5. Zippers

Join the front and side Panels

6. Fabric

Waterproof and UV resistant, rot-proof and washable vinyl

7. Door

It can be positioned on the left side of the front panel and easily moved to the right side of the same

8. Protective sponge

Positioned vertically at the rear of the side panels

9. Vertical Rafter

Telescopic aluminium as standard (2 pieces) to lock the protective sponge

PRIVACY ROOM F45

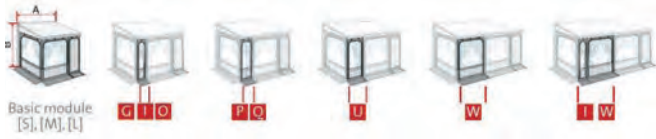

| Part Number | Basic Module |
|--------------------|----------------------|
| 150-02400 S | P. Room Van 260 Van |
| 150-02402 M | P. Room 300 - Medium |
| 150-02406 L | P. Room 300 - Large |

| Part Number | Front Panels |
|--------------------|--------------|
| 150-02451 G | Van 40 cm |
| 150-02453 I | 50 cm |
| 150-02455 O | 75 cm |
| 150-02456 P | 100 cm |
| 150-02457 Q | 125 cm |
| 150-02458 U | 150 cm |
| 150-02459 W | 200 cm |

| Description | Awning length A | Basic module B | Composition | |
|----------------------|-----------------|--------------------------|-------------------------|---------|
| Privacy Room Van 260 | 260 cm | Van [S] | [S] | |
| Privacy Room Van 300 | 300 cm | 180-220 cm | [S] + G | |
| P. Room 300 Medium | 300 cm | Medium [M] 225-250 cm | [M] | |
| P. Room 350 Medium | 350 cm | | [M] + I | |
| P. Room 375 Medium | 375 cm | | [M] + O | |
| P. Room 400 Medium | 400 cm | | [M] + P | |
| P. Room 425 Medium | 425 cm | | [M] + Q | |
| P. Room 450 Medium | 450 cm | | [M] + U | |
| P. Room 300 Large | 300 cm | | Large [L] 251-280 cm | [L] |
| P. Room 350 Large | 350 cm | | | [L] + I |
| P. Room 375 Large | 375 cm | [L] + O | | |
| P. Room 400 Large | 400 cm | [L] + P | | |
| P. Room 425 Large | 425 cm | [L] + Q | | |
| P. Room 450 Large | 450 cm | [L] + U | | |
| P. Room 500 Large | 500 cm | [L] + W | | |
| P. Room 550 Large | 550 cm | [L] + I + W | | |

PRIVACY ROOM F65 / F80



| Part Number | Basic Module |
|--------------------|-----------------------------|
| 150-02410 S | P. Room 300 Ducato >06 |
| 150-02412 M | P. Room 300 H3 * |
| 150-02414 L | P. Room 300 / H: 245-280 ** |

| Part Number | Front Panels |
|--------------------|--------------|
| 150-02450 F | 20 cm |
| 150-02452 H | 40 cm |
| 150-02454 N | 77 cm |
| 150-02456 P | 100 cm |
| 150-02457 Q | 125 cm |
| 150-02458 U | 150 cm |

* Designed for Mercedes Sprinter, VW Crafter, Fiat Ducato, Citroën Jumper and Peugeot Boxer - H3, Fast Clip Light aluminium poles delivered as standard.

** This model is suitable for vehicles with straight wall, height from ground 245-280cm.

| Description | Awning length A | Basic module B | Composition |
|---------------------------|-----------------|---------------------|--------------------------|
| P. Room 300 Ducato >06/06 | 300 cm | Van [S] 245 cm | [S] |
| P. Room 320 Ducato >06/06 | 330 cm | | [S] + F |
| P. Room 340 Ducato >06/06 | 340 cm | | [S] + H |
| P. Room 370 Ducato >06/06 | 370 cm | | [S] + N |
| P. Room 400 Ducato >06/06 | 400 cm | | [S] + P |
| P. Room 425 Ducato >06/06 | 425 cm | | [S] + Q |
| P. Room 450 Ducato >06/06 | 450 cm | | [S] + U |
| P. Room 300 H3 | 300 cm | | Medium [M] 245-280 cm |
| P. Room 320 H3 | 330 cm | [M] + F | |
| P. Room 340 H3 | 340 cm | [M] + H | |
| P. Room 370 H3 | 370 cm | [M] + N | |
| P. Room 400 H3 | 400 cm | [M] + P | |
| P. Room 425 H3 | 425 cm | [M] + Q | |
| P. Room 450 H3 | 450 cm | [M] + U | |
| P. Room 300 / H: 245-280 | 300 cm | Large [L] 280 cm | |
| P. Room 320 / H: 245-280 | 330 cm | | [L] + F |
| P. Room 340 / H: 245-280 | 340 cm | | [L] + H |
| P. Room 370 / H: 245-280 | 370 cm | | [L] + N |
| P. Room 400 / H: 245-280 | 400 cm | | [L] + P |
| P. Room 425 / H: 245-280 | 425 cm | | [L] + Q |
| P. Room 450 / H: 245-280 | 450 cm | | [L] + U |

150-01200

FIAMMA VEHICLE DRAUGHT SKIRT

Great for protection against wind or rain. The Draught Skirt comes with an installation kit which includes snap fasteners and even has skirting protection for your wheels. It can be shortened if required.



SPECIFICATIONS

Dimensions: 550L x 60H cm

150-02200N

FIAMMA SIDE W PRO

Fiamma's side panels can be installed on either side of a Fiamma awning. Suitable for use on F45 awnings from 3m long with 2.5m extension.

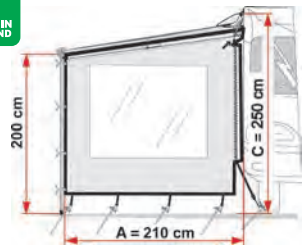

200-08096

FIAMMA SIDE W PRO CARAVAN STORE

Side panel with a large full light Crystal window and vinyl extension to the floor. Made of rot-proof vinyl, washable fabric with UV protection. Simple to install. Delivered as standard with telescopic tension rafter and elastic hooks and pegs. Suits 2.25m and 2.55m awnings.



200-08099

FIAMMA SIDE W PRO CARAVAN STORE XL

Suits 2.8m, 3.1m and 3.6m awnings

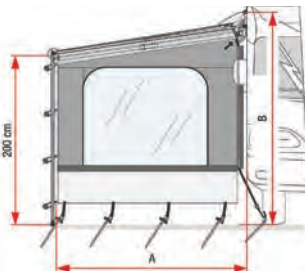

COAST AWNING WALL KITS



An inexpensive alternative for Pop Top and Caravan owners to extend your living space whilst on holiday.

Innovative design has ensured that each Coast Awning Wall Kit is supplied with three doors (one on each wall), giving you flexibility on which side to open up for access. Suitable for rollout awnings (from 11ft - 18ft) these Awning Wall Kits are made from polyester; not only is polyester easy to wash and dry but it is known for its strength and durability.

BENEFITS AT A GLANCE

- > Each window comprises three components: an outer polyester flap, Clear PVC and a flyscreen allowing for permanent airflow minus the insects!
- > Installation is flexible (i.e. it can be fitted using telescopic poles or sail track)
- > A draught skirt and wheel kit is provided with each kit, these are made from a light weight grey PVC
- > Adaptable to suit awnings with its guide track at up to 9ft (2.7m) in height and projections of up to 8ft (2.4m)

SPECIFICATIONS

The walls are constructed of weaved Polyester yarns (0.46mm thick).

The windows are made from clear PVC with a 0.27mm thickness.

The side wall and front wall mudflaps are manufactured from a non-fraying, grey PVC with webbing.

The draft and wheel covers are made from a light weight grey PVC with webbing.

| Part Number | Description |
|------------------|----------------------------|
| 150-03070 | To Suit 11' Rollout Awning |
| 150-03000 | To Suit 12' Rollout Awning |
| 150-03010 | To Suit 13' Rollout Awning |
| 150-03020 | To Suit 14' Rollout Awning |
| 150-03030 | To Suit 15' Rollout Awning |
| 150-03040 | To Suit 16' Rollout Awning |
| 150-03050 | To Suit 17' Rollout Awning |
| 150-03060 | To Suit 18' Rollout Awning |



Awning Wall Kit shown has been installed on a Caravan

ORBIT ASTRO ANNEXE



The Orbit Air Astro Annexe is an inflatable annexe suitable for various caravans and camper trailers.

It is manufactured using high-strength waterproof 300D micro weave poly cotton canvas. Its lightweight structure and modern curved design make it very robust for optimal performance in high winds. The Orbit Air Astro Annexe provides an additional living or storing area while camping or caravanning.

150-06000

ORBIT AIR ASTRO ANNEXE 325 LOW

It protects you, your family, your friends and your gear from weather, dirt and insects. It is spacious and filled with light, while offering superior UV protection. Setting-up the Orbit Air Astro Annexe is simple and easy for anyone! You won't believe how soon your annexe will be set up leaving you to kick back and enjoy your caravanning adventures.

The Orbit Air Astro Annexe comes in 2 different heights to suit a multitude of caravan or camper trailer sizes: there is a "low" version for touring caravans and campers, and a "high" version for off-road variants.

FEATURES

- > Inflatable for easy set-up
- > Roof beam structure for simplistic rigidity
- > Waterproof 300D micro weave poly cotton canvas
- > Superior UV protection: UPF50+
- > Excellent ventilation
- > 3-layered window system (mesh, plastic & canvas)
- > Super quick to set up and take down
- > Wind skirt, ground sheet and dirt skirt included
- > Plastic LED sleeve for fitting an optional LED light strip
- > Pre-attached storm buckles and webbing straps
- > Sail track included
- > Hand pump with pressure gauge included
- > Adjustable ladder bands and steel pegs included
- > All packed in a practical carry bag

150-06002

ORBIT AIR ASTRO ANNEXE 325 HIGH



FIAMMA CARAVANSTORE AWNINGS

A lightweight bag awning with a manual rollout operation. Specifically made for caravans and minivans, the Caravanstore Awning has an extra wide roller tube which can be rewound without the fabric wrinkling. It takes seconds to roll it out and since the legs are inside the roller tube, they too are quick and easy to position. The legs are hinged and telescopic so they can't fall out and get lost. The design of the Caravanstore Awning has been improved recently and it now comes with a Central Rafter fixing kit to ensure a centre rafter is installed safely (from Caravanstore 255). The lead bar now also features a second track so that a sunscreen or LED lights can be utilised.



EASY INSTALLATION

Slides easily into existing sail track. Once unrolled, simply pull out the legs and position accordingly. When it's time to pack up, the roller tube can be rolled up either way.

COLOURS AND MATERIALS

Housed in a soft bag with a self-lubricating zipper that won't get stuck. The canopy is available in Royal Grey and is waterproof, rot proof and UV resistant.

Use the table below to choose the right Caravanstore Awning for your RV.

| Part Number | Description | Awning Length (A) | Canopy Length (B) | Extension (C) | Shade Surface | Weight |
|-------------|------------------|-------------------|-------------------|---------------|-------------------|--------|
| 200-20000 | Caravanstore 190 | 196cm | 162cm | 180cm | 2.9m ² | 6.1kg |
| 200-20002 | Caravanstore 225 | 236cm | 202cm | 225cm | 4.5m ² | 7.6kg |
| 200-20004 | Caravanstore 255 | 266cm | 232cm | 225cm | 5.2m ² | 8.4kg |
| 200-20056 | Caravanstore 280 | 288cm | 254cm | 225cm | 5.7m ² | 9.0kg |
| 200-20058 | Caravanstore 310 | 318cm | 284cm | 225cm | 6.4m ² | 10.2kg |
| 200-20060 | Caravanstore 360 | 369cm | 334cm | 225cm | 7.5m ² | 11.3kg |

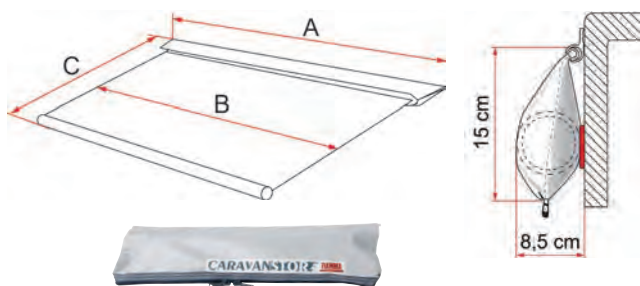

FIAMMA F35 PRO AWNINGS

Perfect for your minivan, 4x4 or even a station wagon. Housed in a light anodized aluminium case, the Fiamma F35 Pro has a manual mechanism—press the red button on the side of the casing to open and then walk backwards while unrolling the awning. The drop down legs are housed inside the roller tube.



Adapters are available to help with installation onto the roof racks of your vehicle. The fabric is printed on both sides on a UV-resistant and waterproof vinyl. The F35 Pro extends up to 225. Also comes with ropes and hooks for securing to the ground. Available in royal grey colour only.

200-20100
FIAMMA F35 PRO 180

Specifications
Length: 180cm
Extension: 180cm
Weight: 6.0kg

200-20102
FIAMMA F35 PRO 220

Specifications
Length: 220cm
Extension: 225cm
Weight: 8.5kg

200-20104
FIAMMA F35 PRO 250

Specifications
Length: 250cm
Extension: 225cm
Weight: 9.0kg

200-20108
FIAMMA F35 PRO 300

Specifications
Length: 300cm
Extension: 225cm
Weight: 10.5kg

FIAMMA F45 S AWNINGS

Fiamma's best selling awning has had a few cosmetic changes, with the result being a more compact and functional box awning. The lead bar now has two tracks allowing for use of a sunscreen and/ or LED lights. The F45 S range of awnings are simple to use and easy to install on the wall of your RV or horse trailer. When not in use, the F45 S takes up little space while snugly enclosed in its polar white aluminium case. It is sturdy and safe to operate, with an easy-to-hook winch loop. The canopy is available in five colours and is UV resistant, waterproof and washable. The colour is printed on both sides of the canopy.

Use the table below to help decide which F45 S awning is right for you.



| Description | Awning Length (A) | Width (B) | Extension (C) | Shade Surface | Weight |
|-------------|-------------------|-----------|---------------|-------------------|--------|
| F45 S 190* | 185cm | 169cm | 100cm | 1.7m ² | 11.5kg |
| F45 S 260 | 263cm | 247cm | 200cm | 4.9m ² | 19.5kg |
| F45 S 300 | 308cm | 292cm | 250cm | 7.3m ² | 23kg |
| F45 S 350 | 348cm | 331cm | 250cm | 8.3m ² | 24kg |
| F45 S 400 | 398cm | 381cm | 250cm | 9.5m ² | 27kg |

* Awning comes without vertical support legs

ALUMINIUM CASE DIMENSION:

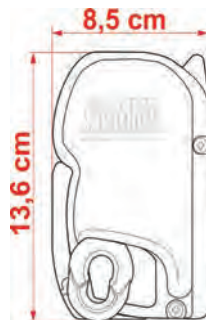
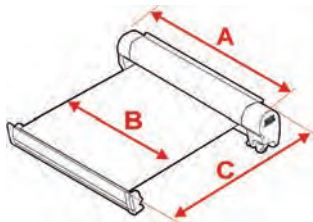

200-20200
FIAMMA F45 S 190
Royal Grey Awning

200-20220
FIAMMA F45 S 230
Royal Grey Awning

200-20240
FIAMMA F45 S 260
Royal Grey Awning

200-20260
FIAMMA F45 S 300
Royal Grey Awning

200-20280
FIAMMA F45 S 350
Royal Grey Awning

200-20300
FIAMMA F45 S 400
Royal Grey Awning

200-20246
FIAMMA F45 S 260
Deep Black Royal Grey Awning

200-20264
FIAMMA F45 S 300
Deep Black Royal Grey Awning

200-20284
FIAMMA F45 S 350
Deep Black Royal Grey Awning



200-20202
FIAMMA F45 S 190
Royal Blue Awning

200-20222
FIAMMA F45 S 230
Royal Blue Awning

200-20242
FIAMMA F45 S 260
Royal Blue Awning

200-20262
FIAMMA F45 S 300
Royal Blue Awning

200-20282
FIAMMA F45 S 350
Royal Blue Awning

200-20302
FIAMMA F45 S 400
Royal Blue Awning



FIAMMA F45 AWNINGS

Perfect for larger RVs the popular F45 TiL has been improved to create the F45 L awnings, featuring an increased box size and extra large roller tube. The F45L awning provides a large shaded area for your family to enjoy on your next holiday. Suitable for mounting onto the wall of your RV, F45 L awnings open and close by means of a crank handle and have a beautiful polar white aluminium case to compliment any RVs exterior. Silent when opening, closing and even during travel, the F45 L range is sturdy and easy to operate. Best of all, the F45 L case features two guide tracks enabling you to have a sunscreen and a front wall installed at the same time if you so choose!



Available in two colours, the vinyls are printed on both sides and are UV-resistant, waterproof and washable to ensure you get quality for your money. Supplied with one Straight Centre Rafter as standard (200-04602).

| Description | Awning Length (A) | Width (B) | Extension (C) | Shade Surface | Weight |
|-------------|-------------------|-----------|---------------|--------------------|--------|
| F45 L 450 | 452cm | 435cm | 250cm | 10.9m ² | 35kg |
| F45 L 500 | 502cm | 485cm | 250cm | 12.0m ² | 39kg |

ALUMINIUM CASE DIMENSION:

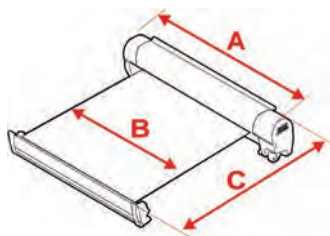

200-20307

FIAMMA F45 S 450

Royal Grey Awning



200-20420

FIAMMA F45 L 500

Royal Grey Awning

200-20308

FIAMMA F45 S 450

Royal Blue Awning



200-20422

FIAMMA F45 L 500

Royal Blue Awning

FIAMMA F80 AWNINGS



The new Fiamma F80s Awning range is the new, modern, and compact awning for roof installation. These awnings have an extremely small cross-section that allows it to integrate better with your vehicle's roof line curvature, and feature a number of improvements on its predecessor, the F65s.

NEW Triple Guide Feature

Three guides on the lead bar for fitting two front panels, awning shades or walls, and other accessories.

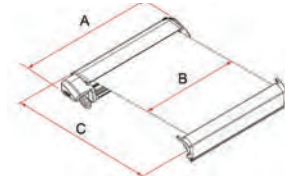
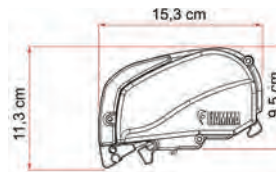

NEW LED Predefined

Position in Lead Bar + Case Housing for optional LED strips are built inside the case as well as the lead bar.

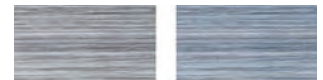

FEATURES

- > Aluminum End Caps: Newly designed aluminum end caps for maximum strength.
- > Extra-Strong Arms: Wider, reinforced and articulated arms with double steel cables for optimal canopy tension.

CANOPY FINISH

Available in two colours

- > Royal Grey
- > Royal Blue

Three Case Colour options available



| Description | Awning Length (A) | Canopy Length (B) | Extension Length (C) |
|-----------------|-------------------|-------------------|----------------------|
| Fiamma F80s 290 | 290cm | 278cm | 200cm |
| Fiamma F80s 320 | 320cm | 308cm | 250cm |
| Fiamma F80s 340 | 340cm | 328cm | 250cm |
| Fiamma F80s 370 | 370cm | 358cm | 250cm |
| Fiamma F80s 400 | 400cm | 388cm | 250cm |
| Fiamma F80s 425 | 425cm | 412cm | 250cm |
| Fiamma F80s 450 | 450cm | 431cm | 250cm |

**F80 POLAR WHITE CASE
- ROYAL GREY CANOPY FINISH**

200-20700
FIAMMA F80S 290 POLAR WHITE AWNING
200-20704
FIAMMA F80S 320 POLAR WHITE AWNING
200-20708
FIAMMA F80S 340 POLAR WHITE AWNING
200-20712
FIAMMA F80S 370 POLAR WHITE AWNING
200-20716
FIAMMA F80S 400 POLAR WHITE AWNING
200-20720
FIAMMA F80S 425 POLAR WHITE AWNING
200-20724
FIAMMA F80S 450 POLAR WHITE AWNING

**F80 POLAR DEEP BLACK CASE
- ROYAL GREY CANOPY FINISH**

200-20756
FIAMMA F80S 290 DEEP BLACK AWNING
200-20760
FIAMMA F80S 320 DEEP BLACK AWNING
200-20764
FIAMMA F80S 340 DEEP BLACK AWNING
200-20768
FIAMMA F80S 370 DEEP BLACK AWNING
200-20772
FIAMMA F80S 400 DEEP BLACK AWNING
200-20776
FIAMMA F80S 425 DEEP BLACK AWNING
200-20780
FIAMMA F80S 450 DEEP BLACK AWNING

**80 POLAR TITANIUM CASE
- ROYAL GREY CANOPY FINISH**

200-20728
FIAMMA F80S 290 TITANIUM AWNING
200-20732
FIAMMA F80S 320 TITANIUM AWNING
200-20736
FIAMMA F80S 340 TITANIUM AWNING
200-20740
FIAMMA F80S 370 TITANIUM AWNING
200-20744
FIAMMA F80S 400 TITANIUM AWNING
200-20748
FIAMMA F80S 425 TITANIUM AWNING
200-20752
FIAMMA F80S 450 TITANIUM AWNING

**F80 POLAR WHITE CASE
- ROYAL BLUE CANOPY FINISH**

200-20702
FIAMMA F80S 290 POLAR WHITE AWNING
200-20706
FIAMMA F80S 320 POLAR WHITE AWNING
200-20710
FIAMMA F80S 340 POLAR WHITE AWNING
200-20714
FIAMMA F80S 370 POLAR WHITE AWNING
200-20718
FIAMMA F80S 400 POLAR WHITE AWNING
200-20722
FIAMMA F80S 425 POLAR WHITE AWNING
200-20726
FIAMMA F80S 450 POLAR WHITE AWNING

FIAMMA F80 AWNINGS

SECTION

F80 POLAR WHITE CASE - ROYAL GREY CANOPY FINISH



- 200-20700
FIAMMA F80S 290 POLAR WHITE AWNING
- 200-20704
FIAMMA F80S 320 POLAR WHITE AWNING
- 200-20708
FIAMMA F80S 340 POLAR WHITE AWNING
- 200-20712
FIAMMA F80S 370 POLAR WHITE AWNING
- 200-20716
FIAMMA F80S 400 POLAR WHITE AWNING
- 200-20720
FIAMMA F80S 425 POLAR WHITE AWNING
- 200-20724
FIAMMA F80S 450 POLAR WHITE AWNING

F80 POLAR DEEP BLACK CASE - ROYAL GREY CANOPY FINISH



- 200-20756
FIAMMA F80S 290 DEEP BLACK AWNING
- 200-20760
FIAMMA F80S 320 DEEP BLACK AWNING
- 200-20764
FIAMMA F80S 340 DEEP BLACK AWNING
- 200-20768
FIAMMA F80S 370 DEEP BLACK AWNING
- 200-20772
FIAMMA F80S 400 DEEP BLACK AWNING
- 200-20776
FIAMMA F80S 425 DEEP BLACK AWNING
- 200-20780
FIAMMA F80S 450 DEEP BLACK AWNING

80 POLAR TITANIUM CASE - ROYAL GREY CANOPY FINISH



- 200-20728
FIAMMA F80S 290 TITANIUM AWNING
- 200-20732
FIAMMA F80S 320 TITANIUM AWNING
- 200-20736
FIAMMA F80S 340 TITANIUM AWNING
- 200-20740
FIAMMA F80S 370 TITANIUM AWNING
- 200-20744
FIAMMA F80S 400 TITANIUM AWNING
- 200-20748
FIAMMA F80S 425 TITANIUM AWNING
- 200-20752
FIAMMA F80S 450 TITANIUM AWNING

F80 POLAR WHITE CASE - ROYAL BLUE CANOPY FINISH



- 200-20702
FIAMMA F80S 290 POLAR WHITE AWNING
- 200-20706
FIAMMA F80S 320 POLAR WHITE AWNING
- 200-20710
FIAMMA F80S 340 POLAR WHITE AWNING
- 200-20714
FIAMMA F80S 370 POLAR WHITE AWNING
- 200-20718
FIAMMA F80S 400 POLAR WHITE AWNING
- 200-20722
FIAMMA F80S 425 POLAR WHITE AWNING
- 200-20726
FIAMMA F80S 450 POLAR WHITE AWNING

F80 POLAR TITANIUM CASE - ROYAL BLUE CANOPY FINISH



- 200-20730
FIAMMA F80S 290 TITANIUM AWNING
- 200-20734
FIAMMA F80S 320 TITANIUM AWNING
- 200-20738
FIAMMA F80S 340 TITANIUM AWNING
- 200-20742
FIAMMA F80S 370 TITANIUM AWNING
- 200-20746
FIAMMA F80S 400 TITANIUM AWNING
- 200-20750
FIAMMA F80S 425 TITANIUM AWNING
- 200-20754
FIAMMA F80S 450 TITANIUM AWNING

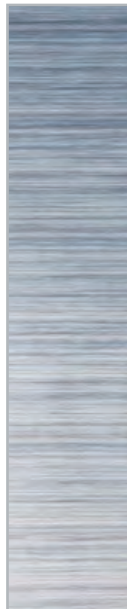

200-04600 FIAMMA CURVED CENTRE RAFTER PRO

A curved rafter which helps to eliminate water pooling and the canopy from flapping in the wind. It is easy to install, keeps the fabric taut and also provides more under-canopy clearance. Made from two anodized aluminium telescopic bars, the Rafter Pro is best suited to awnings that have an extension of up to 250cm. Its minimum length is 144cm but can extract to 265cm.

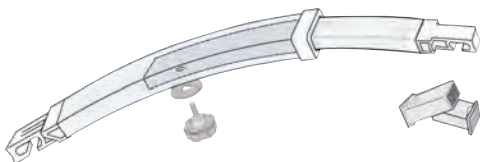

200-04602 FIAMMA STRAIGHT CENTRE RAFTER

Made from anodised aluminium, the Straight Rafter helps to keep the awning taut. It comes with wall clips allowing you to mount it, for storage, inside your vehicle. Best suited to awnings that extend up to 250cm, the Straight Rafter's extension ranges from 142cm - 265cm.



200-04612 FIAMMA CARAVANSTORE CENTRE RAFTER XL



FIAMMA ADAPTOR BRACKETS

If you like the look of Fiamma's F45 range of awning but your RV does not have a flat-walled surface to mount it on, do not worry! Fiamma have a range of adapter brackets allowing you to fit an F45 awning to your RV, some of which don't require any drilling!

200-04630 FIAMMA AWNING VW T2/T3 FITTING BRACKETS FOR F45

Suitable for VW T2 and VW T3 vehicles manufactured after 1980. No drilling required. Kit comprised of x2, 8cm brackets.

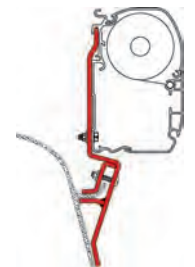

200-04632 FIAMMA AWNING VW T4 FITTING BRACKETS FOR F45

Suitable for VW T4 and VW T4 with a Lift Roof. Drilling required. Kit comprised of x2, 8cm brackets.



200-04634 FIAMMA AWNING VAN FITTING BRACKETS FOR F45

Suitable for vans such as Fiat Ducato (manufactured before 1994), Ford Transit, Mercedes Sprinter 208D KB. Drilling required. Kit comes with x2 types of brackets (x2 of each supplied), one suits Fiat Ducato (manufactured before 1994); the other suits Ford Transit, Mercedes Sprinter 208D KB. Brackets are 8cm in length.

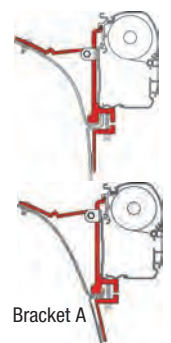

Bracket A

200-04635

FIAMMA AWNING FIX INSTALL BRACKET "S" (1PCE)

Suitable for RV's with a flat outer wall. An optional extra bracket for those who wish to strengthen their current mounting. Drilling required. Kit comprises of x1, 12cm "S" bracket.



200-04643

FIAMMA F45 ADAPTOR KIT FOR FORD TRANSIT CUSTOM (RHD 2012 ON)

Fiamma F45 Adaptor Kit for Ford Transit Custom (RHD 2012 on)

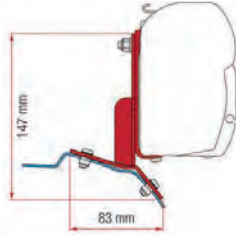

200-04653

FIAMMA AWNING MOUNTING BRACKET FOR F45 15 DEGREE

Suitable for RV's with a slight curve towards the rooftop and for those wanting to mount the awning closer towards the curve of the roof. Drilling required. Kit comprised of x1, 11cm bracket.

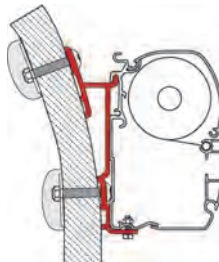

200-04682

FIAMMA F65S AWNING FIXING KIT

Suitable for VW Crafter and Mercedes Sprinters with high roofs built after June 2006. Comprised of x1 12cm bracket, x1 53cm bracket and x1 60cm bracket.



200-04714

FIAMMA F35 AND CARAVANSTORE PLASTIC RIVET

Snap on rivets for the awning leg end on the following models: F35, Caravanstore, F45 and F65. Sold in pairs.



FIAMMA AWNING RAIN GUARDS

Awning rain guards are a great solution to prevent water from dripping behind the space where your Fiamma awning has been mounted. Made of rubber, the rain guard is installed onto the awning case (no need to remove the awning). Comes in three widths and in 550cm lengths.

200-04802

FIAMMA AWNING RAIN GUARD L 550CM

Suited to awnings that have been fitted using one of the adapter brackets that resulted in a gap of up to 9cm between the awning case and the RV wall. Can also be used on curved walls.

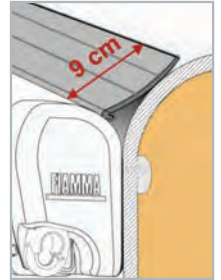

200-04806

FIAMMA AWNING RAIN GUARD M 550CM

For awnings, mounted with adapter spaced out from the wall (up to 4cm) or on curved walls.

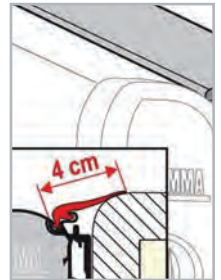

200-04811

FIAMMA AWNING RAIN GUARD S 550CM

For awnings installed with the standard AS120 bracket on flat walls. Fits the 1.6cm gap between the flat wall of the RV and the back of the awning case.

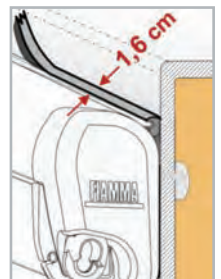

200-04896

FIAMMA WINDING HANDLE TELESCOPIC

This telescopic handle is standard delivered with the F45L awning. Made from light aluminium, it is ideal for high motor homes or caravans, allowing users to easily unwind their awning without stretching. Weighs only 1.32kg. Min length is 154cm but can extend up to 240cm.

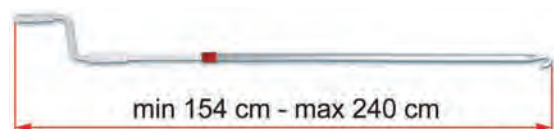

200-04898**FIAMMA WINDING HANDLE STANDARD 123CM**

This 123cm crank handle is standard delivered with F45S awnings up to 400cm. It has a folding handle and is made of ultra light aluminium. It can be cut down if required and weighs only 0.4kg.

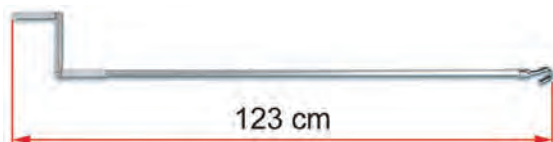
**200-04900****FIAMMA WINDING HANDLE SHORT 51CM**

The shortest of Fiamma's crank handles the 51cm version is also made of light aluminium, meaning it only weighs 0.24kg. Ideal for smaller/ lower RVs.

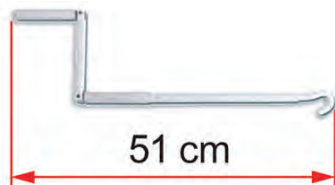
**200-04901****FIAMMA ALU WALL BRACKETS FOR AWNING LEGS**

Made of aluminium, these are installed on the outside wall of your RV, allowing you to mount the legs of awning on the side of your RV (instead of vertically dropping to the ground). Suitable for Fiamma F45S, F45L, F65, Caravanstore and F35 awnings. Comes in a set of 2.

**200-04902****FIAMMA LEG WALL BRACKET KIT FOR F45 AWNINGS**

These wall brackets are made of a sturdy, white plastic to complement the colour of your RV. Suitable for F45S and F45L awnings. Comes in a set of 2.

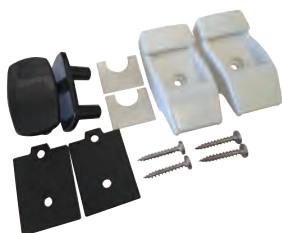
**200-04910****FIAMMA LEG WALL BRACKET KIT FOR F45 AWN DEEP BLACK****200-05316****FIAMMA F45 TI SUPPORT LEG REGULATION HAND WHEEL KIT**

This hand wheel secures the extendable legs on Fiamma awnings at the chosen height.

**200-08002****FIAMMA FAST CLIP**

Used to attach the walls of a Fiamma Privacy Room to an awning canopy, the improved Fast Clip system is suitable for use on awnings with a 250cm extension only. Its upper bar is now divided into 4 pieces allowing for precise closing at each section. Each section is now stronger with strengthened joints to minimise central bending. The levers have been made stationary (they can't come out of their position) and larger. This allows for easier unhooking. By turning the levers, the grip on the awning canopy can be increased/decreased. The plastic end caps have been shaped to limit damage to the side walls when threading them into the track on the Fast Clip System.

**200-08004****FIAMMA TIEDOWNS (BLACK)**

A Fiamma tie-down that allows for solid anchoring. It fits into the awning rails or the side clip of the privacy room. Comes with two 300cm adjustable bands and the necessary stakes and tension springs.

- > 2x Tie Downs
- > 2x Front Hooks
- > 2x Springs
- > 2x Stakes

**FIAMMA ADAPTORS****200-08007****FIAMMA ADAPTER KIT**

Fiamma Adaptor kit to suit side w pro 4m and under.

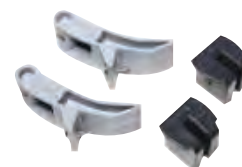
**200-08008****ADAPTER KIT FOR CLIP SYSTEM TO FIT FIAMMA F65 AWNINGS****200-08009****ADAPTER KIT FOR CLIP SYSTEM TO FIT FIAMMA F45 TIL AWNINGS**

250-02037

FIAMMA DELUXE 5B LADDER

A quality aluminium ladder for sleeping berths in RVs. It has a 15° inclination and handy nylon hooks to hold it in position. The 5B Ladder has five steps.

Weighs: 2.6kg

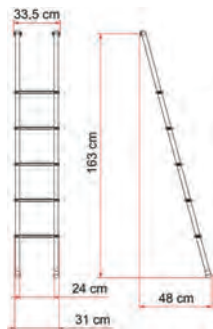

250-02039

FIAMMA DELUXE 6 DJ

A sturdy and lightweight external ladder with non-skid steps. Made from anodised aluminium, it is supplied with fixing bars for quick and easy installation on the rear door. It can also be combined with the Carry Bike 200 DJ (part number 350-02096). The Deluxe 6 DJ is suitable for installation on the following vehicles: Fiat Ducato, Citroen Jumper, Peugeot Boxer and Ford Transit (with double rear doors built after 2006). It has six steps.

Weighs: 6.5kg

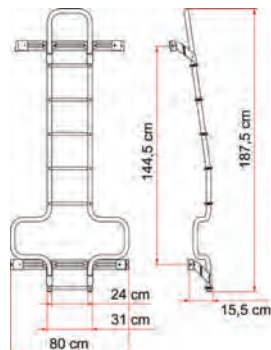

250-02040

FIAMMA DELUXE 8 EXTERNAL LADDER

A quality aluminium ladder that is sturdy enough for external use. It has a comfortable 24cm step width with non-skid rungs for added safety. The 8 External Ladder can be folded up during travel and can be installed on the following vehicles: Fiat Ducato, Citroen Jumper, Peugeot Boxer and the Ford Transit (with double rear doors built after 2006). It has eight steps.

Weighs: 5.5kg



AUSSIE TRAVELLER ANTI-FLAP KITS

Aussie Traveller's new standard AFK with provision for LED lighting (not available yet but coming soon). Contains an additional external sail-track for the easy addition of a patio awning extension. Aussie Traveller's patented Anti Flap Kit offers a wind and waterproof method to attach walls to your awning.

Aussie Traveller has designed the Anti-Flap Kit (AFK) to help overcome two of the major problems faced by owners of all brands of roll-out awnings.

1. It Helps to Prevent Wind Flap and
2. It has the Ability to Successfully Add Walls.

The Anti-Flap Kit (AFK) breaks down to 4 individual sections (2 pieces per end) which when joined together, form a full-length clamp. This full-length clamp holds to the awning fabrics' outside edge and helps prevent wind flap. It also includes a sail track to accept walls.

200-12300

AUSSIE TRAVELLER SHORT ANTI FLAP KIT - WITHOUT LED WHITE

Suited to rollout awnings that extend from 210cm up to 220cm



200-12301

AUSSIE TRAVELLER BLACK SHORT ANTI FLAP KIT - WITHOUT LED

Suited to rollout awnings that extend from 210cm up to 220cm



200-12310

AUSSIE TRAVELLER MEDIUM ANTI FLAP KIT - WITHOUT LED WHITE

Suited to rollout awnings that extend from 220cm up to 230cm

200-12311

AUSSIE TRAVELLER BLACK MEDIUM ANTI FLAP KIT - WITHOUT LED

Suited to rollout awnings that extend from 220cm up to 230cm

200-12320

AUSSIE TRAVELLER LONG ANTI FLAP KIT - WITHOUT LED WHITE

Suited to rollout awnings that extend from 230cm up to 240cm

200-12321

AUSSIE TRAVELLER BLACK LONG ANTI FLAP KIT - WITHOUT LED

Suited to rollout awnings that extend from 230cm up to 240cm

200-12181

AUSSIE TRVELLER LOCKING KNOB + T-NUT

Replacement knob and T-nut that suits Aussie Traveller anti-flap kits and curved roof rafters.



200-12183

AUSSIE TRAVELLER AFK BRACKET

Replacement stainless steel mounting brackets that suit Aussie Traveller anti-flap kits and curved roof rafters.



200-12186

AUSSIE TRAVELLER AFK POLE HOLDER BRACKET

Steel bracket to support a pole along an Aussie Traveller anti-flap kit.



200-12216

AUSSIE TRAVELLER AFK CAM HANDLES

Replacement Aussie Traveller anti-flap kit cam handle with spring and nut.



AWNING DE-FLAPPER KITS

Helps to protect awnings from costly rips and tears while reducing wind flapping. The de-flapper securely holds the awning fabric by means of hook and loop velcro straps. Made of durable nylon with UV stabilizers.

200-08174

CAMCO DEFLAPPER KIT W/VELCRO STRAPS (UNIVERSAL FIT)

(set of 2)



200-08176

CAMCO MAX DEFLAPPER KIT W/VELCRO STRAPS (UNIVERSAL FIT)

(set of 2)



200-08019

COAST PREMIUM AWNING TIE DOWN KIT

The ultimate tie down kit to keep your awning safe and secure! It can help prevent damage to your awning caused by high winds.



200-08020

HAPPY HOOK AWNING TIE DOWN KIT

Designed to pull the roller tube down to tighten the awning vinyl and reduce flapping caused by wind.



200-08150

RV AWNING STABILISER KIT

Secure your awning economically. Extra holding power of spiral stakes works well in all kinds of soil. Tension units keep ropes securely taut. Easy-to-use kit stores compactly and fits all roll out awnings. Great for use on the beach, it attaches to the ends of the roller bar on your awning. Fits all awnings



200-08160

AWNING HOLD DOWN STRAP KIT

Secures your roll out awning by distributing the tension evenly across the canopy. It is a wrinkle resistant strip that fits awnings up to 25'. Kit includes strap, stakes, springs and brackets.



200-08034 RV TWINTRAK FOR HANGING LIGHTS

Suitable for awnings up to 18' (5.5m), the Twintrak conveniently turns a single track into a twin track. It allows you to hang sunscreens, lights or other RV accessories all at the same time. Made from strong plastic the Twintrak is supplied in x6, 3' (x6, 91.4cm) pieces.



200-08082 FIXMYTEAR - 30CM CLEAR REPAIR PATCH

Fixmytear is popular product used to repair a variety of vinyl tears it is perfect for the caravan awnings and can even be used on canvas found in truck curtains, jumping castles, inflatable boats, boat sails, rubber waders, tents & more.



200-08144 RV AWNING PARTY LIGHT HOOKS

Sturdy sewn fabric tabs with grommets that slide into the roller bar channel of your awning. It enables you to hang lights, wind chimes and other lightweight items from the edge of your canopy. Each pack contains x7 tabs.



200-08086 CAMCO RV AWNING REPAIR TAPE - 3' WIDE X 15' LONG

Camco's RV Awning Repair Tape is a permanent repair for rips and punctures on your RV awning. Use it for RV, boat sails, canvas, tents, rain wear, backpacks, popup campers and more. It has an aggressive adhesive and resists tearing in any direction. The roll is 7.6cm wide x 4.57m long.



200-08142 AWNING HARDWARE STRAPS

These Velcro straps allow you to replace old or lost awning straps belonging to your rollout awning. They measure 12" (30.5cm) and can also be used to secure other items such as leads or hoses around your RV. Comes in a pack of two.



200-08270 COAST CURVED ROOF RAFTER (WHITE)

Designed to give your awning canopy a gentle curve enabling rain to run off with ease. Keeping your awning canopy taut it also minimises flapping caused by wind. The Coast Curved Rafter is suitable for awnings that extend up to 8ft (243cm).



200-08080 VLP VINYL REPAIR TUBE

Great for mending pinholes, rips or tears on awnings and canvas. VLP is a clear, high strength and flexible adhesive that is suitable for use on most types of flexible vinyl surfaces. It has an air dry formula that dries clear, thus blending with coloured fabric. Typical use is on vinyl furniture, awnings, tarps, vinyl sheeting, luggage, rain gear, covers, tent floors and boots. All surfaces to be glued must be free of oil and dust: to achieve this, simply wipe the surface with alcohol and let it dry before applying VLP.



Specifications

Temperature Use Range: -10°F to 200°F
(-23.3°C to 93.3°C)

Tensile: (ASTM D-882) 2900Psi

COAST PREMIUM RAFTERS

Featuring a curved top which is gentle against awning fabric, these rafters are designed to give your awning a curve and avoid water pooling. This clever rafter also keeps awning fabric taut and to minimise flapping, this is especially helpful during the rainy season, or in windy areas where your awning is more likely to get damaged.

200-08272

GENTLE-CURVED AWNING RAFTER

- Extends to 274cm



200-08273

HIGH-CURVED AWNING RAFTER

- Extends to 273cm



200-08276

COAST PREMIUM - BLACK GENTLE-CURVED AWNING RAFTER

- Extends to 274cm



200-08278

COAST PREMIUM - BLACK HIGH-CURVED AWNING RAFTER

- Extends to 273cm



150-00110

SPIGOT MOUNT BRACKET

Suitable for use with steel extension poles and curved roof rafters.



AUSSIE TRAVELLER CURVED ROOF RAFTERS

Curved Roof Rafters have a dual purpose - to prevent the awning canopy from sagging, ensuring water run-off, and for keeping the awning fabric taut, reducing wind flap. Awnings that flap can cause your RV to shake or even cause damage to the awning itself. Aussie Traveller has produced two types of telescopic Curved Roof Rafters - suiting most brands of rollout awnings.

Please see the guide below to see how many rafters are recommended per awning:

| Awning Size | Recommendation |
|---------------|----------------|
| 11' and under | 1 |
| 12' - 16' | 2 |
| 17' - 20' | 3 |
| 21' and over | 4 |

200-08280

AUSSIE TRAVELLER CURVED ROOF RAFTER MAXI INCLUDING BRACKET

Specifications

Curve: 90mm

Extension: 1400 - 2580 (mm)



200-08282

AUSSIE TRAVELLER MINI CURVED ROOF RAFTER INCLUDING BRACKET

Specifications

Curve: 60mm

Extension: 1400 - 2580 (mm)



200-12184

AUSSIE TRAVELLER SPIGOT T/S ROOF RAFTER

Replacement Spigot that suits Aussie Traveller curved roof rafters.



200-12185

AUSSIE TRAVELLER END HOOK T/S ROOF RAFTER

Replacement End Hook that suits Aussie Traveller anti-flap kits and curved roof rafters.



200-34180

CAREFREE AWNING DOOR ROLLER N' DISC



JAYCO CAMPER BAG AWNING POLES



Designed for Jayco Camper Bag Awnings, these handy poles can be used to replace those that have been lost or damaged.

SPRING LOADED FRONT POLES

Available in the range there are 4 sizes of spring loaded Front poles that range from 8 to 12 ft. These support the front length of the awning and can be broken down into smaller sizes for easier storage.



UPRIGHT POLE

The Upright pole features a rubber foot for grip and stability and are made to clip into a Front pole. The Upright pole can be extended and feature a convenient locking mechanism. Lift the handle and the pole can extend or retract, close the handle and the pole is securely locked in place.



TOP POLE

The Top pole has a hooked end that slots into the mounting point on a Jayco Camper and are also made to clip into the Front pole. The Top pole can be extended and feature a convenient locking mechanism. Lift the handle and the pole can extend or retract, close the handle and the pole is securely locked in place.



| Part Number | Description |
|------------------|---------------------------------------|
| 200-01002 | Upright Pole No 2. UP-2-SM |
| 200-01003 | Top Pole No 3. UP-1-SM |
| 200-01008 | Front Pole for 8ft Awning. FP-3-8FT |
| 200-01010 | Front Pole for 10ft Awning. FP-3-10FT |
| 200-01011 | Front Pole for 11ft Awning. FP-3-11FT |
| 200-01012 | Front Pole for 12ft Awning. FP-3-12FT |



COAST FLOOR MATTING

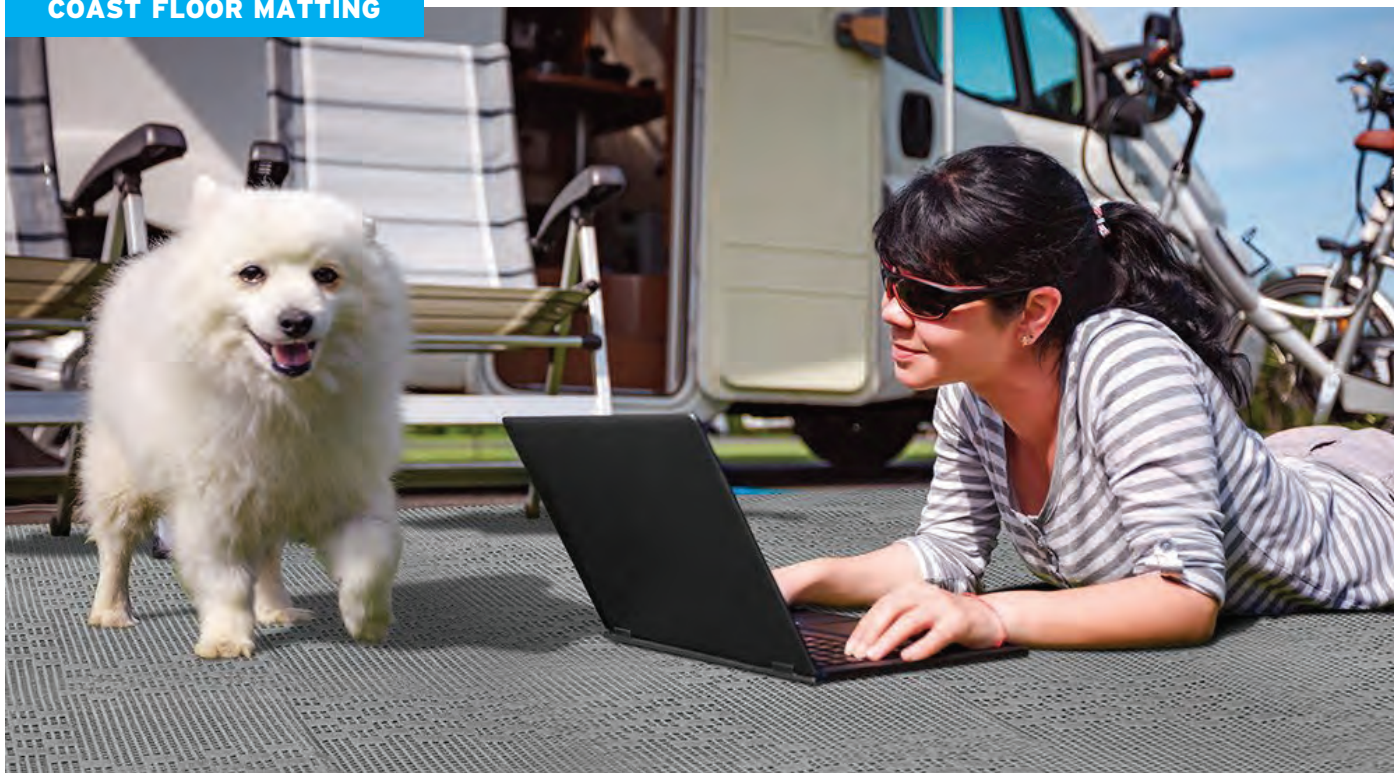

Great for any outdoor activity (or even around the home), this floor matting is made from ultra lightweight foamed PVC making it a soft, breathable mat that won't kill the grass! It has a non slip feature so items you place on it will stay where you left them. This is a hard wearing, durable mat that has endless uses.

TRAVELITE MATTING

200-08610

GREY - 250CM X 300CM

(comes with carry bag)

200-08612

GREY - 250CM X 400CM

(comes with carry bag)

200-08614

GREY - 250CM X 500CM

(comes with carry bag)

200-08616

GREY - 250CM X 600CM

(comes with carry bag)



PREMIUM MATTING

200-08640

GREY - 250CM X 300CM - 5KG

(comes with carry bag)

200-08642

GREY - 250CM X 400CM - 6KG

(comes with carry bag)

200-08644

GREY - 250CM X 500CM - 8KG

(comes with carry bag)

200-08646

GREY - 250CM X 600CM - 10KG

(comes with carry bag)



TIDY TURF MATS

All Tidy Turf Mats are made in Australia from high-quality UV resistant materials, and come in any size or shape needed to compliment your caravan or campsite. Designed to minimise dust and dirt, or add a little comfort to hard and unforgiving camping surfaces, there is a size and shape to suit.

200-08800
TIDY TURF MATS
HOW'S THE SERENITY MAT
- 20 X 49CM



The How's The Serenity Caravan Fold Down Step Mat is perfect for the first step into or out of your van. This mat feature two hook and loop straps, that secure the mat firmly onto your fold down step.

TIDY TURF MATS
BONNIE DOON

The Bonnie Doon Mat Caravan Inner Step Mat inserts perfectly into the door cavity of your caravan. Making it the 'Dirt Buster' for your home on the road. Simply shake it out each day to remove any caught debris. This little gem is a must for all the frequent travellers.



200-08802
BONNIE DOON SMALL MAT - 26X55CM

200-08804
BONNIE DOON LARGE MAT - 29X61CM

200-08806
BONNIE DOON JAYCO SILVERLINE - 24.5X60.5CM

200-08808
TIDY TURF MATS
ARE WE SQUARE YET MAT
- 29X61CM



The Are We Square Yet? Caravan Inner Step Mat features square edges that can insert perfectly into the square edged door cavity of your caravan. Making it the perfect choice for your home on the road.

TIDY TURF MATS
NUGGET SMALL MAT

The Nugget Mat features two velcro straps to firmly secure the mat onto a portable alloy step.



200-08810
NUGGET SMALL MAT
- 30X48CM

200-08812
NUGGET LARGE MAT
- 37X48CM

200-08814
TIDY TURF MATS
ADVENTURE MAT - 50X80CM

The Adventure Mat is our most versatile mat. This mat secure a velcro strap to easily secure when you roll it up to take on your adventure.



200-08816
TIDY TURF MATS
MONSOON MAT - 100X100

The Monsoon Mat is designed to fit inside your pop up ensuite tent. Stop all the mud and dirt ruining your refreshing clean shower.



200-08818
TIDY TURF MATS
TELL HIM HE'S DREAMING
MAT - 60X150CM

The Tell Him He's Dream'in Swag Mat will be your camping best friend. Roll this little beauty out alongside your swag and notice the sand/dirt free sleep.



200-08820
TIDY TURF MATS
THE DONK MAT - 100X150CM

Makes for a fantastic family size mat, it will even fit your pooch. It's nice having something that's a little larger for the times you're camping on sand or dirt.



ENDUROMATS

Perfect for camping, these Australian made mats help to keep your RV cleaner. Small dirt particles, such as sand, fall through the mesh, leaving larger stones on top for easy removal. Made of a PVC welded fibre, Enduromats are strong, durable and tough but not on the grass underneath! The mesh style fabric allows air to move beneath its surface allowing grass to breathe. Non-slip and mildew resistant, the lightweight mat is easy to carry and store. Because nothing sticks to the Enduromat, minimal maintenance is required. To clean, simply shake the mat and then fold as per normal to put back into the bag. It is even UV resistant so it will maintain its colour for years.

200-08400**ENDUROMAT FOREST GREEN
(2M X 2.45M)****200-08402****ENDUROMAT FOREST GREEN
(3M X 2.45M)****200-08404****ENDUROMAT FOREST GREEN
(4M X 2.45M)****200-08406****ENDUROMAT FOREST GREEN
(5M X 2.45M)****200-08408****ENDUROMAT FOREST GREEN
(6M X 2.45M)****200-08410****ENDUROMAT FOREST GREEN
(7M X 2.45M)****200-08450****ENDUROMAT BLACK (2M X 2.45M)****200-08452****ENDUROMAT BLACK (3M X 2.45M)****200-08454****ENDUROMAT BLACK (4M X 2.45M)****200-08456****ENDUROMAT BLACK (5M X 2.45M)****200-08458****ENDUROMAT BLACK (6M X 2.45M)****200-08460****ENDUROMAT BLACK (7M X 2.45M)**

TRAVELITE FRONT SUNSCREENS



Coast to Coast have a brand-new range of Travelite Sunscreens that offer plenty of shade and privacy around the RV at an unbeatable price. The new Travelite range is designed to suit most popular awning styles and van types including roll out awnings, box awnings, campers and features end walls to suit both caravans and pop tops. Travelite Sunscreens are a great value solution for additional shade and privacy for your RV's outdoor living area. Each sunshade is backed by a huge 4-year warranty and features double stitched edges to prevent fraying. Travelite makes fitting a sunshade as easy as ever, simply thread the spline through the track in your awnings lead bar or utilise the Velcro straps for an end wall. Travelite is the new benchmark for great value sunshades, each one comes complete with D rings, guy ropes, heavy duty pegs and a convenient, zip-up storage bag.

TRAVELITE FRONT SUNSCREEN TO SUIT ROLLOUT AWNING

- > Suitable for use with most popular brands of rollout awnings
- > D-rings, guy ropes and carry bag included



200-09400
COAST TRAVELITE SUNSCREEN - W2805MM X H1800MM
- T/S 10FT ROLL-OUT AWNING

200-09402
COAST TRAVELITE SUNSCREEN - W3110MM X H1800MM
- T/S 11FT ROLL-OUT AWNING

200-09404
COAST TRAVELITE SUNSCREEN - W3415MM X H1800MM
- T/S 12FT ROLL-OUT AWNING

200-09406
COAST TRAVELITE SUNSCREEN - W3720MM X H1800MM
- T/S 13FT ROLL-OUT AWNING

200-09408
COAST TRAVELITE SUNSCREEN - W4025MM X H1800MM
- T/S 14FT ROLL-OUT AWNING

200-09410
COAST TRAVELITE SUNSCREEN - W4330MM X H1800MM
- T/S 15FT ROLL-OUT AWNING

200-09412
COAST TRAVELITE SUNSCREEN - W4635MM X H1800MM
- T/S 16FT ROLL-OUT AWNING

200-09414
COAST TRAVELITE SUNSCREEN - W4940MM X H1800MM
- T/S 17FT ROLL-OUT AWNING

200-09416
COAST TRAVELITE SUNSCREEN - W5245MM X H1800MM
- T/S 18FT ROLL-OUT AWNING

TRAVELITE FRONT SUNSCREEN TO SUIT FIAMMA AND CAREFREE BOX AWNING

- > Suitable for use with most popular brands of box awnings
- > D-rings, guy ropes and carry bag included

**200-09418****COAST TRAVELITE SUNSCREEN - W2850MM X H1800MM - T/S 3.0M BOX AWNING****200-09420****COAST TRAVELITE SUNSCREEN - W3350MM X H1800MM - T/S 3.5M BOX AWNING****200-09422****COAST TRAVELITE SUNSCREEN - W3850MM X H1800MM - T/S 4.0M BOX AWNING****TRAVELITE CAMPER PRIVACY SUNSCREENS OFFSIDE**

Coast to Coast now has a new range of Camper Privacy Sunscreens, that are perfect for shading the kitchen area in most campers as well as providing privacy.

**200-09424****COAST TRAVELITE CAMPERVAN OFFSIDE PRIVACY SUNSCREEN W2220MM X H2050MM****200-09426****COAST TRAVELITE CAMPERVAN OFFSIDE PRIVACY SUNSCREEN W2780MM X H2050MM****200-09428****COAST TRAVELITE CAMPERVAN OFFSIDE PRIVACY SUNSCREEN W3060MM X H2050MM****200-09430****COAST TRAVELITE CAMPERVAN OFFSIDE PRIVACY SUNSCREEN W3380MM X H2050MM****TRAVELITE SIDE SUNSCREEN FOR POP-TOPS**

- > One size fits most caravans and can fit the left or the right side depending on your needs
- > D-rings, guy ropes and carry bag included
- > Dimensions: 2100W x 1800H (mm)

**200-09432****COAST TRAVELITE SUNSCREEN SIDE WALL FOR POP-TOP (HEIGHT: 1.80M)****TRAVELITE SIDE SUNSCREEN FOR CARAVANS**

- > One size fits most caravans and can fit the left or right side depending on your needs
- > D-rings, guy ropes and carry bag included
- > Dimensions: 2350mm x 2100mm x 1900mm

**200-09434****COAST TRAVELITE SUNSCREEN SIDE WALL FOR FULL VAN (HEIGHT: 1.90M/2.35M)**

PREMIUM COAST FRONT SUNSCREENS



Coast's range of sunscreens has been redesigned resulting in a stronger and more functional sunshade. The front and side sunshades now feature an improved spline that won't kink over time. There are also newly added reinforcing triangles (with D-rings) that enable the sunshade to be secured to awning legs. They are still quick and easy to fit. Once you have taken it out of the packaging, shake it out like a blanket and grab the end without the eyelets. Simply thread it through the track on your awning lead bar.

KEY FEATURES

- > Improved spline
- > Added reinforced triangles with D-rings
- > Hemmed edging all around to prevent fraying
- > Comes with guy ropes and heavy duty 8mm steel pegs (for securing to the ground)
- > Offers extra privacy
- > Now with a huge 5 year warranty

ARPAN5A TEST RESULTS

- > Cover Factor: 91.0 +/- 2.5
- > UVR Block: 90.4% +/- 2.5%
- > Shade Factor: 86.6 +/- 2.9
- > Calculated Protection Factor: 11*

* The Calculated Protection Factor is for the material only and does not account for the effect of indirect UVR when situated at a distance from the persons being protected.

Now available in Black finish

FRONT SUNSCREENS FOR ROLLOUT AWNINGS

- 200-09002 - Grey Finish
- 200-09005 - Black Finish
- SUITS 10' ROLLOUT AWNING (W2805MM X H1800MM)**
- 200-09012 - Grey Finish
- 200-09015 - Black Finish
- SUITS 11' ROLLOUT AWNING (W3110MM X H1800MM)**
- 200-09022 - Grey Finish
- 200-09025 - Black Finish
- SUITS 12' ROLLOUT AWNING (W3415MM X H1800MM)**
- 200-09032 - Grey Finish
- 200-09035 - Black Finish
- SUITS 13' ROLLOUT AWNING (W3720MM X H1800MM)**
- 200-09042 - Grey Finish
- 200-09045 - Black Finish
- SUITS 14' ROLLOUT AWNING (W4025MM X H1800MM)**
- 200-09052 - Grey Finish
- 200-09055 - Black Finish
- SUITS 15' ROLLOUT AWNING (W4330MM X H1800MM)**
- 200-09062 - Grey Finish
- 200-09065 - Black Finish
- SUITS 16' ROLLOUT AWNING (W4635MM X H1800MM)**

200-09072 - Grey Finish
200-09075 - Black Finish
SUITS 17' ROLLOUT AWNING (W4940MM X H1800MM)

200-09082 - Grey Finish
200-09085 - Black Finish
SUITS 18' ROLLOUT AWNING (W5245MM X H1800MM)

* Rollout awning sunscreens have a 6mm spline

FRONT SUNSCREENS FOR BOX AWNINGS

200-09102 - Grey Finish
200-09105 - Black Finish
SUITS FIAMMA AND CAREFREE 3M BOX AWNING (W2850MM X H1800MM)

200-09112 - Grey Finish
200-09115 - Black Finish
SUITS FIAMMA AND CAREFREE 3.5M BOX AWNING (W3350MM X H1800MM)

200-09122 - Grey Finish
200-09125 - Black Finish
SUITS FIAMMA AND CAREFREE 4M BOX AWNING (W3850MM X H1800MM)

* Box awning sunscreens have a 3mm spline



200-09192
REPLACEMENT BAG FOR 10" - 12" SUNSCREENS

200-09194
REPLACEMENT BAG FOR 13" - 16" SUNSCREENS

200-09196
REPLACEMENT BAG FOR 17" - 18" SUNSCREENS

COAST SIDE SUNSCREENS

Available to suit Pop Tops and Caravans, the Coast Side Sunscreens are made from the same quality material as the Front Sunscreens. In the case of a Pop Top, the side sunshade attaches to your awning arm (when extended) by means of velcro straps. If you have a Caravan, you have two installation options; 1) use the Velcro straps to attach it to your awning arm or, 2) if you already have an antiflap device installed with sail track, simply thread the side sunshade spline through the track. Comes with guy ropes and pegs to secure to the ground. Comes with a huge 5 year warranty!

200-09202 - Grey Finish
200-09205 - Black Finish
SIDE SUNSCREEN FOR POP-TOP (W2100 X H1800MM)



200-09212 - Grey Finish
200-09215 - Black Finish
SIDE SUNSCREEN FOR CARAVANS

* Can also fit into the Fiamma Fast Clip System



200-09198
REPLACEMENT BAG FOR SIDE SUNSCREENS

CAMPER OFFSIDE PRIVACY SUNSCREENS

Coast to Coast now has a NEW range of camper privacy sunscreens. These are perfect for shading the kitchen and fridge area in most campers as well as providing privacy.

- > Used on the offside of the camper for extra shade and privacy
- > No poles required with a height of 2050mm
- > Suitable for use with most popular brands of camper vans
- > Huge 5 year warranty

200-09300 - Grey Finish

200-09305 - Black Finish

**CAMPER OFFSIDE PRIVACY SUNSCREEN
(W2220 X H2050MM)**

200-09302 - Grey Finish

200-09315 - Black Finish

**CAMPER OFFSIDE PRIVACY SUNSCREEN
(W2780 X H2050MM)**

200-09304 - Grey Finish

200-09325 - Black Finish

**CAMPER OFFSIDE PRIVACY SUNSCREEN
(W3060 X H2050MM)**

200-09306 - Grey Finish

200-09335 - Black Finish

**CAMPER OFFSIDE PRIVACY SUNSCREEN
(W3380 X H2050MM)**



COAST FRIDGE VENT SUNSCREENS

200-09350 - Grey Finish

200-09355 - Black Finish

COAST FRIDGE VENT SUNSCREEN

Designed to shade the fridge area of your RV. The Coast Fridge Sunscreen will lower the ambient temperature around your fridges vents allowing the fridge to perform better on hot sunny days. The Coast Fridge Sunscreen comes with almost everything you need to install the screen yourself, including 1100mm of sailtrack and eight 12mm x 6 gauge stainless steel mounting screws. To give the finishing touches, the installation kit also includes mould insert to cover the mounting screws and specially designed caps for each end of the sailtrack.

FEATURES

- > DIY Installation Kit (includes sailtrack, mounting screws, mould insert and end caps)
- > Kink free 6mm spline
- > Tough reinforced D-rings
- > Hemmed edges all around to prevent fraying
- > Guy ropes and heavy duty 8mm steel pegs (for securing to the ground)
- > Comes with a huge 5 year warranty.



CAREFREE ALTITUDE

Altitude introduces a new high in awning intelligence and style. This advanced awning helps set your RV apart from the crowd with features you might find on much higher priced products.

Altitude makes the outdoors the 'coolest' part of any RV. Today's RV owners enjoy entertainment, connectivity and technology that simplify RV living. Our Altitude awnings are loaded with the latest technological features including operation through the Bluetooth™ enabled smart phone app that allows you to extend, retract your awning, turn of/on or dim the LED light, and even adjust Carefree Motion's sensitivity to wind.

Altitude™ has been developed to provide OEMs an easy to install, contemporary patio awning that fits the lifestyles and tastes of today's younger, more tech savvy, on-the-go RV buyers. It follows Carefree's automotive styling and is designed to complement the Caravan sidewall rather than clutter it.

FEATURES

- > Memory Pitch. Awning extends out to the same pitch it was retracted from.
- > Exclusive Pitch Adjustments. Now with easier to use buttons for adjustment and you can change the pitch when the awning is closed!
- > Bluetooth Enabled. The optional wireless awning control system and mobile app allows you to control awning extension, retraction, LED lighting, and the sensitivity of the wireless motion sensor right from your mobile device.



- 200-37200**
120INCH/10FT SILVERFADE
- 200-37210**
132INCH/11FT SILVERFADE
- 200-37220**
144INCH/12FT SILVERFADE
- 200-37230**
156INCH/13FT SILVERFADE
- 200-37240**
168INCH/14FT SILVERFADE
- 200-37250**
180INCH/15FT SILVERFADE
- 200-37260**
192INCH/16FT SILVERFADE
- 200-37270**
204INCH/17FT SILVERFADE
- 200-37280**
216INCH/18FT SILVERFADE
- 200-37290**
228INCH/19FT SILVERFADE

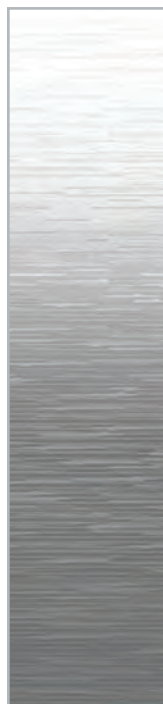

- 200-37300**
120INCH/10FT BLACK REVERSE FADE
- 200-37310**
132INCH/11FT BLACK REVERSE FADE
- 200-37320**
144INCH/12FT BLACK REVERSE FADE
- 200-37330**
156INCH/13FT BLACK REVERSE FADE
- 200-37340**
168INCH/14FT BLACK REVERSE FADE
- 200-37350**
180INCH/15FT BLACK REVERSE FADE
- 200-37360**
192INCH/16FT BLACK REVERSE FADE
- 200-37370**
204INCH/17FT BLACK REVERSE FADE
- 200-37380**
216INCH/18FT BLACK REVERSE FADE
- 200-37390**
228INCH/19FT BLACK REVERSE FADE



CAREFREE ALTITUDE AWNING HARDWARE

Suitable for pop-tops & caravans due to their compact height. The pitch angle is adjustable with six different levels thanks to a simple but sturdy pin setup. The Altitude hardware also features inbuilt shocks for reliability that will soak up bumps and jarring while on the road. They are strong enough to support the awning without the use of legs, but if your planning longer stays, Carefree recommend the use of their HD Support Pole Kit 200-33066 (coming soon).

- 200-33014**
CAREFREE ALTITUDE WHITE AWNING HARDWARE SET



- 200-33016**
CAREFREE ALTITUDE BLACK AWNING HARDWARE SET



200-37430 CAREFREE ALTITUDE BT-12 CARAVAN ELECTRONICS

This optional electronics kit enables Bluetooth™ operation of the Altitude through a compatible smart device. It also includes a Combination switch that allows a Master ON/OFF as well as a one touch EXTEND or RETRACT button. This kit allows you to:

- > Open & Close the awning
- > Turn the LED light bar On
- > Adjust the brightness of your LED light bar
- > Position the angle of the LED by bringing in or taking out the Awning
- > Adjust the optional motion switches sensitivity to complete override if this is installed
- > Get your exact extension every-time you open the awning via setting the memory in the app
- > Bluetooth module included



200-37438 CAREFREE ALTITUDE BT-12 CONTROL MODULE

This part here is a replacement Bluetooth module on its own if required, its function is to communicate all functions from the switch or app to the awning.



200-37440 CAREFREE ALTITUDE LED SWITCH WITH FUSE

Simply an on/off switch to operate the LED bar from the inside of the van, this switch can be installed in any inside location but will need to be hardwired in to work. simple item for a simple operation & includes a fuse for added safety.



ALTITUDE ACCESSORIES

200-37432 CAREFREE ALTITUDE BT-12 MOTION SWITCH

This switch mounts on the awning to detect unwanted motion such as wind. If extreme wind is detected it will tell the awning to promptly get out of harm's way by automatically retracting. This is a great bit of insurance should you be away from your van and the wind suddenly picks up.



200-37442 CAREFREE ALTITUDE EXTEND & RETRACT SWITCH WITH DYNAMIC BRAKE

If the BT-12 option is not suited to your customers, maybe due to it being too "TECH SAVY" for the end user or if the OEM wants to still have the New Motorised hardware for ease of operation but it's a cost sensitive option then this Manual operation switch will be needed at a minimum.

To use simply hold down the OUT button to extend the awning and when the awning is fully extended you let go of the button, to retract simply hold down the IN button and again let go when the awning is completely rolled up in its travel position. If your customer wishes to use their OWN switching/control system ensure it has a "DYNAMIC BRAKE" ability built into the switch or the unit will not operate correctly.



200-37434 CAREFREE ALTITUDE BT-12 REMOTE

A great little extra as with this simple remote control so you can open and close your awning as well as turn on the LED & adjust the brightness without having open up a smart device.



200-37436 CAREFREE ALTITUDE BT-12 SWITCH KIT

This is a replacement switch which is mounted to the interior of the van which is then hardwired into the BT Module, it will control the basic operation of the awning being extend or retract as well as master power on/off switch.



200-33066**CAREFREE ALTITUDE HD SUPPORT POLE KIT**

The new Carefree Altitude HD Support Pole Kit is a purpose-designed support pole kit to suit Carefree's Altitude Awning, and other rollout awnings without support legs. Staying in one place for an extended time with an Altitude awning will require them to have some kind of upright support.

The HD Support Pole Kit comes with two connecting heads so it can be used to support awnings with roll bars as well as box awnings. They are designed to fit both Carefree and other branded awnings.

Important! When using this kit with Altitude awnings, or any powered awning, ensure that the awning's power is switched OFF prior to installation! This prevents any sensors the awning has from activating and causing it to retract. If you need to adjust the awning pitch after set up, loosen the pole's straps and lower before adjusting.

FEATURES

- > Cradle head to support awnings with roll bars
- > Stabiliz'r Grip head to allow securing to a box awning
- > Poles feature crank knobs to secure the pole to the adjusted height
- > Comes with stakes and straps to secure the poles to the ground and awning.
- > Designed for quick set up, under 5 minutes!

**200-33070****CAREFREE STRAIGHT RAFTER - WHITE****200-33072****CAREFREE STRAIGHT RAFTER - BLACK**

Carefree's new Straight Rafter is a straight rafter designed to add rigidity and further support to your awning.

Installing the Straight Rafter is simple and easy with two methods of connecting to the roller tube available. The rafter can be attached using the pin with a hole drilled into the roller tube or with no drilling into the roller tube required the mounting cradle fits around the roller tube and firmly holds the rafter in place.

The Straight Rafter also includes an industry first utility slot to quickly hang side blockers, side panels or other awning accessories.

The Straight Rafter is available in Black and White hardware colour options.

200-33080**CAREFREE CURVED RAFTER - WHITE****200-33082****CAREFREE CURVED RAFTER - BLACK**

Carefree's new Curved Rafter is a curved rafter designed to add rigidity and further support to your awning.

Installing the Curved Rafter is simple and easy with two methods of connecting to the roller tube available. The rafter can be attached using the pin with a hole drilled into the roller tube or with no drilling into the roller tube required the mounting cradle fits around the roller tube and firmly holds the rafter in place.

The Curved Rafter also includes an industry first utility slot to quickly hang side blockers, side panels or other awning accessories.

The Curved rafter is available in Black and White hardware colour options .

CAREFREE ROLL OUT WINDOW AWNINGS

Window awnings offer an alternative to roll out awnings but still provide essential protection from the sun. Carefree have modified their window awnings to incorporate a more streamlined design. The vinyl has also been given an update to an opaque white, complementary to any RV exterior. Two types of Carefree Window Awning are available, the SL and the SL XL. The SL window awning is suitable for windows less than 36" (91cm) in height. If your window is more than 36" in height, you will require the SL XL window awning.

**200-31012****SL 4FT WHITE WINDOW AWNING****200-31014****SL 5FT WHITE WINDOW AWNING****200-31016****SL 6FT WHITE WINDOW AWNING****200-31512****4FT WHITE SL XL WINDOW AWNING****200-31514****5FT WHITE SL XL WINDOW AWNING**

CAREFREE WINDOW AWNING HARDWARE

**200-31902
SL WHITE WINDOW
AWNING HARDWARE**

Capable of 18" (46cm) extension

**200-31960
SL XL WHITE WINDOW
AWNING HARDWARE**

Capable of 30" (76cm) extension



CAREFREE FIESTA ROLL OUT AWNINGS (NO ARMS)

Carefree's vinyl fabric features a superior construction with the top portion being called the Weatherguard - this protects the fabric from the sun, scrapes and exposure when the awning is rolled up. The Carefree Fiesta has long been a favourite amongst RVers, not only in the USA but here in Australia as well. It is a simple to use manual, spring loaded, rollout awning featuring a vinyl weatherguard as previously mentioned. The 8' - 14' awnings project up to 7'3" (2.21m), while the awnings from 15' - 21' project up to 7'9" (2.36m).



FIESTA FEATURES

Remote and Travel Locks

These work together to ensure the Fiesta does not come undone during travel. They eliminate the need for you to stretch and fumble for the roller lock.



Canopy Clamps

Built onto the hardware and self storing. Canopy Clamps help to keep your awning taught and provide extra protection from the elements. Not available on arms supplied to suit poptops.



Heavy Duty Brackets

Solid and rugged, the awning hardware and castings are white to suit the trim of any RV.



Single Track Slider

Located on the inside of the hardware channels, it eliminates the rafter binding during setup and storage. You get a smooth gliding motion as soon as you slide the rafters up the hardware arms



CAREFREE ROLL OUT AWNINGS

- 200-36900 10FT BLACK SHALE FADE
- 200-36910 11FT BLACK SHALE FADE
- 200-36920 12FT BLACK SHALE FADE
- 200-36930 13FT BLACK SHALE FADE
- 200-36940 14FT BLACK SHALE FADE
- 200-36950 15FT BLACK SHALE FADE
- 200-36960 16FT BLACK SHALE FADE
- 200-36970 17FT BLACK SHALE FADE
- 200-36980 18FT BLACK SHALE FADE
- 200-36990 19FT BLACK SHALE FADE
- 200-36992 20FT BLACK SHALE FADE
- 200-36994 21FT BLACK SHALE FADE

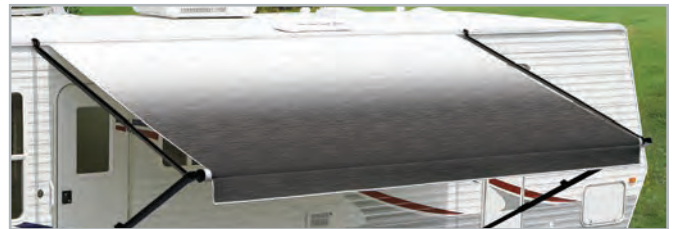

- 200-36400 10FT BLUE SHALE FADE
- 200-36410 11FT BLUE SHALE FADE
- 200-36420 12FT BLUE SHALE FADE
- 200-36430 13FT BLUE SHALE FADE
- 200-36440 14FT BLUE SHALE FADE
- 200-36450 15FT BLUE SHALE FADE
- 200-36460 16FT BLUE SHALE FADE
- 200-36470 17FT BLUE SHALE FADE
- 200-36480 18FT BLUE SHALE FADE



200-36500 10FT BURGUNDY SHALE FADE
200-36510 11FT BURGUNDY SHALE FADE
200-36520 12FT BURGUNDY SHALE FADE
200-36530 13FT BURGUNDY SHALE FADE
200-36540 14FT BURGUNDY SHALE FADE
200-36550 15FT BURGUNDY SHALE FADE
200-36560 16FT BURGUNDY SHALE FADE
200-36570 17FT BURGUNDY SHALE FADE
200-36580 18FT BURGUNDY SHALE FADE



200-36700 10FT SILVER SHALE FADE
200-36710 11FT SILVER SHALE FADE
200-36720 12FT SILVER SHALE FADE
200-36730 13FT SILVER SHALE FADE
200-36740 14FT SILVER SHALE FADE
200-36750 15FT SILVER SHALE FADE
200-36760 16FT SILVER SHALE FADE
200-36770 17FT SILVER SHALE FADE
200-36780 18FT SILVER SHALE FADE
200-36790 19FT SILVER SHALE FADE
200-36792 20FT SILVER SHALE FADE
200-36794 21FT SILVER SHALE FADE



CAREFREE LED AWNINGS

Carefree's new LED awning option will make you the envy of the campsite with an adjustable light that is bright enough to read by. This fun, energy-saving dimmable LED's look incredible & are great for parties or just enjoying the evening outside. The 11'-15' awnings project up to 7'3" (2.21m), while the awnings from 16'-20' project up to 7'9" (2.36m).

200-37010 11FT LED SILVER SHALE FADE
200-37020 12FT LED SILVER SHALE FADE
200-37030 13FT LED SILVER SHALE FADE
200-37040 14FT LED SILVER SHALE FADE
200-37050 15FT LED SILVER SHALE FADE
200-37060 16FT LED SILVER SHALE FADE
200-37070 17FT LED SILVER SHALE FADE
200-37080 18FT LED SILVER SHALE FADE
200-37090 19FT LED SILVER SHALE FADE
200-37092 20FT LED SILVER SHALE FADE



CAREFREE TRIPLE BLACK AWNING

It is a simple to use manual, spring loaded, rollout awning featuring a vinyl weatherguard as previously mentioned. Sizes vary - the 11' - 14' awnings project up to 7'3" (2.21m), while the awnings from 15' - 20' project up to 7' 6 3/4" (2.30m).

FEATURES

- > Black Springs
- > Black Weather Guard (so they roll up black)
- > Black Shale Fade Canopy (when rolled out the canopy has a black balance)

LED

- 200-37110 11FT TRIPLE BLACK SHALE FADE
- 200-37120 12FT TRIPLE BLACK SHALE FADE
- 200-37130 13FT TRIPLE BLACK SHALE FADE
- 200-37140 14FT TRIPLE BLACK SHALE FADE
- 200-37150 15FT TRIPLE BLACK SHALE FADE
- 200-37160 16FT TRIPLE BLACK SHALE FADE
- 200-37170 17FT TRIPLE BLACK SHALE FADE
- 200-37180 18FT TRIPLE BLACK SHALE FADE
- 200-37190 19FT TRIPLE BLACK SHALE FADE
- 200-37192 20FT TRIPLE BLACK SHALE FADE

NO LED

- 200-35710 10FT FIESTA TRIPLE BLACK SHALE FADE
- 200-35720 11FT FIESTA TRIPLE BLACK SHALE FADE
- 200-35730 12FT FIESTA TRIPLE BLACK SHALE FADE
- 200-35740 13FT FIESTA TRIPLE BLACK SHALE FADE
- 200-35750 14FT FIESTA TRIPLE BLACK SHALE FADE
- 200-35760 15FT FIESTA TRIPLE BLACK SHALE FADE
- 200-35770 16FT FIESTA TRIPLE BLACK SHALE FADE
- 200-35780 17FT FIESTA TRIPLE BLACK SHALE FADE
- 200-35790 18FT FIESTA TRIPLE BLACK SHALE FADE



When replacing the Spring Assembly on your Carefree Fiesta (rollout) awning, take note of the following:

SPRING WIND CHART

| Length of Awning | Winds with Awning Closed | Winds with Awning Open |
|--|--------------------------|------------------------|
| 7'11" or less | 6 | 14 |
| 8' - 12' | 5 | 13 |
| 12' 1" - 18' | 7 | 15 |
| 18' 11" and longer | 8 | 16 |
| To wind, rotate the end plug over the top and away from the RV | | |
| To unwind, rotate the end plug over the top and toward the RV | | |

CAREFREE ECLIPSE AWNINGS

The Carefree Eclipse awning is yet another innovative design from these 40 year strong manufacturers. It is a 12V electric awning that extends (and retracts) at the touch of a button (usually mounted near the door of your RV). You can choose to unwind it partially or to its 2.3m full extension. As the worm-gear motor unwinds the canopy, the arms glide up the vertical track (mounted to the outside wall of your RV). The end result is a stable canopy with truss like support. To retract the Eclipse simply hold the button and the motor will roll it up tight against your RV and that's it, eliminating the need to fumble for roller locks:



ECLIPSE FEATURES

Unmatched Performance
Eclipse has remarkable strength and support for an automatic awning, not to mention it's stylish good looks.



SELF LEVELLING

No need to level the canopy before you roll it up and the genius part is that when you do unwind it again, it will unwind to its last setting.



RAIN-DUMP FEATURE

When your Eclipse is on a flat pitch and rain is pooling on the canopy, the gas strut will momentarily retract and dump the water.



ADJUSTABLE PITCH

There are 6 settings on the awning arm giving you options to maximise shelter from the sun and rain.



200-36800

14' ECLIPSE 12V SILVER SHALE FADE (NO ARMS, NO SPRINGS)

200-36810

15' ECLIPSE 12V SILVER SHALE FADE (NO ARMS, NO SPRINGS)

200-36820

16' ECLIPSE 12V SILVER SHALE FADE (NO ARMS, NO SPRINGS)

200-36830

17' ECLIPSE 12V SILVER SHALE FADE (NO ARMS, NO SPRINGS)

200-36840

18' ECLIPSE 12V SILVER SHALE FADE (NO ARMS, NO SPRINGS)



** All Carefree awnings are sold in two components, the vinyl and the hardware (arms). The hardware required will vary depending on size and type of RV. Please contact a Coast Team member to determine the correct hardware for your RV.*

200-33000

CAREFREE WHITE SHORT HARDWARE (POP TOP)

Best suited for Pop Tops or smaller caravans with a straight outer wall i.e. walls with a height of 1.6m - 1.7m from the floor line up to the awning railing.



200-33002

CAREFREE BLACK SHORT HARDWARE (POP TOP)

Suitable for use on Pop Tops or smaller caravans with a straight outer wall i.e. walls with a height of 1.6m - 1.7m from the floor line, up to the awning railing.



200-33008

CAREFREE BLACK LONG HARDWARE (UNIVERSAL)

Suitable for use on larger caravans with a straight outer wall i.e. walls with a height of 1.7m - 2.1m from the floor line, up to the awning railing.



200-33010

CAREFREE WHITE LONG HARDWARE (UNIVERSAL)

Best suited for larger caravans with a straight outer wall i.e. walls with a height of 1.7m - 2.1m from the floor line up to the awning railing. Comes with remote lock.



200-33012

CAREFREE AWNING HARDWARE 12V ECLIPSE

12V Awning arms to suit the Eclipse awning. Must be fitted to a flat-walled caravan or motor home. It is 10.8cm wide and requires 1.8mt from the awning rail to the floor line.



200-33020

CAREFREE WHITE CURVED HARDWARE BENT TOP AND BENT LEG

Suits RV's with a curved outer wall.



200-33022

CAREFREE WHITE CURVED HARDWARE BENT TOP AND STRAIGHT LEG

Suits most RV's with a curved roof such as Winnebagos and Renault Trafic.



200-34150

CAREFREE SPIGOT KIT FOR CAREFREE RAFTERS

The Spigot pin fits into the end of the Carefree Centre Rafter, which is then inserted into the awning barrel when extended.



200-33030

CAREFREE RAFTER STANDARD

The standard rafter has an awning support cradle and is easy to use. The end with the awning support cradle attaches to your RV wall, allowing the rafter to swing out towards the awning roller (once extended). Simply tighten the knob on the roller and use the lever to fit to the roller. You can make the canopy as tight as you desire but take care not to stress your canopy roller. Comes in polar white and suits the Carefree Fiesta range of awnings.



200-33040 - White

200-33042 - Black

CAREFREE RAFTER WITH GROUND SUPPORT

Has the same benefits as the standard rafter but with an additional ground support leg. This prevents the awning roller from sagging (towards the ground) once the awning has been rolled out. The ground support and roller work together to keep the awning roller straight. Comes in polar white.



CAREFREE SUPPORT CRADLE

Fits all roller awning brands, the awning support has a pivoting head. Once you roll up your awning, the pivoting head receives the roller and supports it, eliminating weight stress and potential bowing in the centre of your awning roller. The awning supports will not damage the awning fabric. Recommended for use on flat walls of RVs and for awning widths of 16ft or greater.

200-33050

CAREFREE AUTOMATIC AWNING SUPPORT CRADLE WHITE



200-33060

CAREFREE AUTOMATIC AWNING SUPPORT CRADLE BLACK



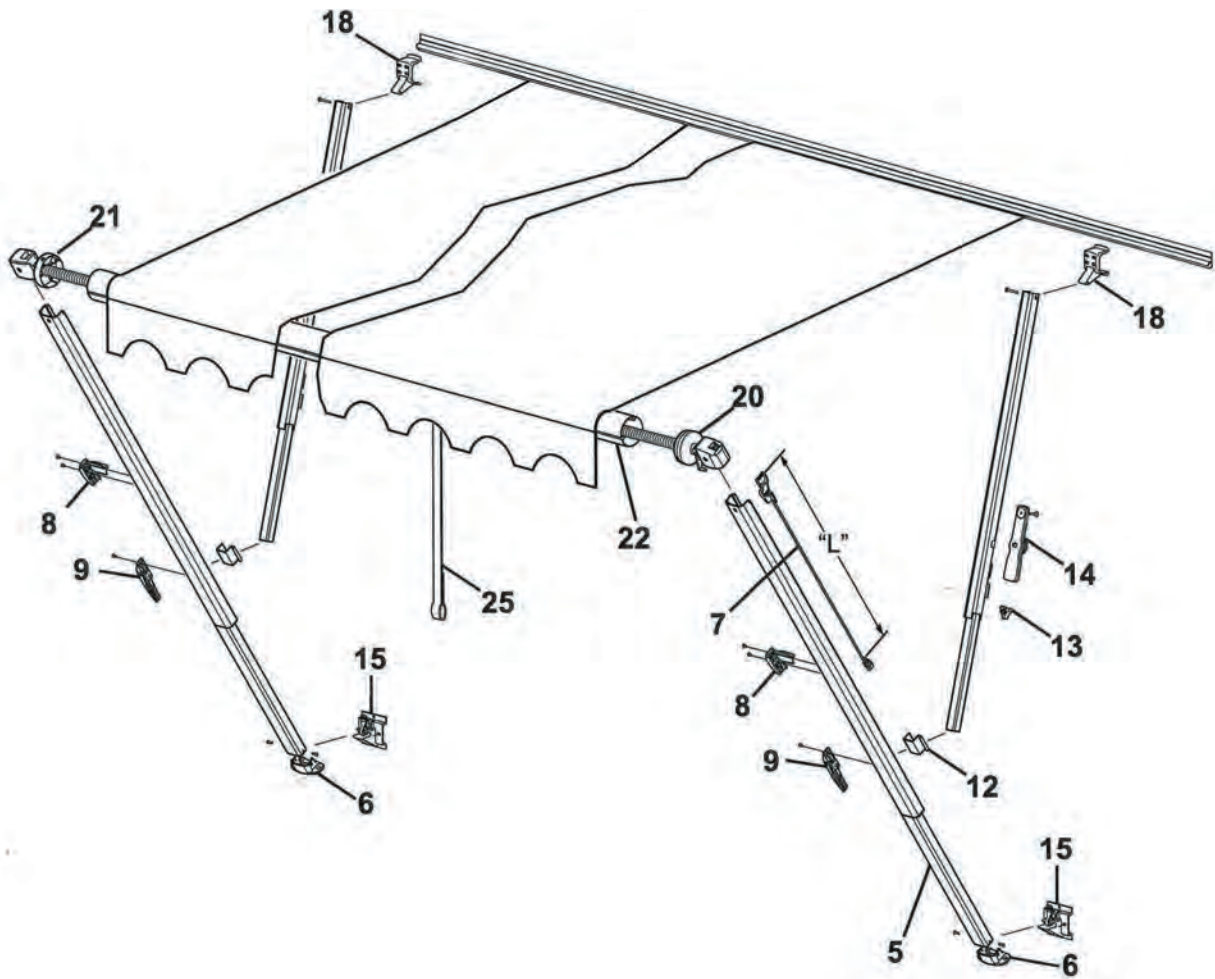

| No. | Carefree Part No. | Coast Part No. | Description |
|-----|-------------------|------------------|--|
| 6 | 901020 | 200-34200 | Carefree BLACK car port foot for main inner arm |
| | 901020W | 200-34070 | Carefree WHITE car port foot for main inner arm |
| 7 | 901046W | 200-34040 | Carefree hardware remote lock WHITE - length: 38.5" (97.8cm) |
| | 901046 | 200-34214 | Carefree hardware remote lock BLACK - length: 38.5" (97.8cm) |
| 8 | 901017 | 200-34202 | Carefree BLACK travel lock |
| | 901017W | 200-34050 | Carefree WHITE travel lock |
| 9 | 901015W | 200-34060 | Carefree WHITE lift handle |
| | 901015 | 200-34204 | Carefree BLACK lift handle |
| 12 | R00405 | 200-34090 | Carefree brace slider assembly |
| 13 | 901022 | 200-34120 | Carefree pair of BLACK locking knob with nut |
| 14 | 902801W | 200-34130 | Carefree pair of WHITE canopy clamps |
| 15 | 901019W | 200-34080 | Carefree WHITE bottom bracket |
| | 901019 | 200-34206 | Carefree BLACK bottom bracket |
| 18 | 901018W | 200-34140 | Carefree WHITE top bracket |
| | 901018 | 200-34208 | Carefree BLACK top bracket |

| | | | |
|----|----------------|------------------|--|
| 20 | R00925WHT | 200-34032 | Carefree WHITE spring assembly cam end for 8'to18' awning (r/hand) |
| | R00925BLK | 200-34212 | Carefree BLACK spring assembly cam end for 8'to18' awning (r/hand) |
| | R00926WHT | 200-34036 | Carefree spring assembly cam end 18' to 21' awning (r/hand) |
| 21 | R00923WHT | 200-34030 | Carefree WHITE spring assembly non cam end for 8'to18' awning (l/hand) |
| | R00923BLK | 200-34210 | Carefree BLACK spring assembly non cam end for 8'to18' awning (l/hand) |
| | R00924WHT | 200-34034 | Carefree spring assembly non cam end 18'to21' awning (l/hand) |
| 25 | R022406-001 | 200-34160 | Pull down strap for Carefree Fiesta awning |
| | 030573 | 200-34194 | Carefree Screw 1/4" 20UNC x 1/4" LG S/Steel |
| | R030345-007-MP | 200-34196 | Carefree Semi Tube Rivet |
| | 901035 | 200-34170 | Carefree Pull Down Wand |

Note: Awning 7'11" and shorter use only x1 R/Hand Spring i.e. there is no L/Hand Spring

TIPS FOR CAREFREE AWNINGS: CARE AND MAINTENANCE

FABRIC CARE

- > Do not use oil-based cleaners or any granulated/ abrasive type cleaners on your Carefree awning.
- > The easiest way to delay the need for a deep clean is to simply hose down the awning fabric once a month with clear water - this prevents dirt from becoming set into the fabric.
- > When the time comes for a thorough cleaning, you can leave the fabric on the frame. For vinyl fabric, simply use a soft brush and warm water with a natural soap. Allow the fabric to air dry completely before rolling back up.

MILDEW

- > A fungus that looks like dirt.
- > Common in areas where temperature and humidity is high, mildew can become a problem.
- > Rinse fabric with clean water and allow to air dry completely before rolling back up.

LEAKING

- > On vinyl canopies, side hems and poly cords are stitched with a sewing machine.
- > The stitching may allow water to seep through - this is normal and not a warranty defect.
- > In this instance, treat the seams with a seam sealer.

ARM CARE

- > Always keep this clean to allow the arms and braces to operate smoothly.
- > Periodically wash out the arm channels with a hose to keep them clean and eliminate dirt and debris.
- > Once the arms have been cleaned and dried completely, you can spray the joints with a dry silicone lubricant.

CAREFREE FREEDOM 12V AWNINGS

Streamlined and easy to operate, Carefree have released the Freedom 12V box awning that mounts onto the side of your RV. By utilising the button installed inside your RV, you can open and retract the awning. Whilst opening the awning, the support arms (located in the lead bar) can be unfolded once it is at a comfortable and easy-to-reach height. The Freedom's support arms are adjustable by means of flip lock controls. To retract the awning, simply fold support arms back into the lead bar and press the button; the awning case closes and locks itself, so you are ready to continue your journey. The Freedom 12V awnings are housed in an attractive white aluminium casing and are available in two canopy colours.

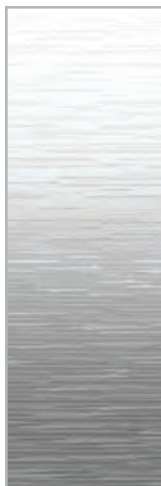

Use the table below to determine which Freedom 12V awning is best for you:

| Awning Size | Canopy Width | Canopy Extension |
|-----------------------------------|--------------|------------------|
| Freedom 2.5m | 2.4m | 2m |
| Freedom 3m | 2.8m | 2.4m |
| Freedom 3.5m | 3.3m | 2.4m |
| Freedom 4m | 3.8m | 2.4m |
| Freedom 4.5m | 4.3m | 2.4m |
| Box Dimensions: 14.5H x 9.1D (cm) | | |
| Power Requirements: 12V, 15A | | |



200-38100

FREEDOM 2.5M SILVER SHALE FADE

200-38110

FREEDOM 3.0M SILVER SHALE FADE

200-38120

FREEDOM 3.5M SILVER SHALE FADE

200-38130

FREEDOM 4.0M SILVER SHALE FADE

200-38140

FREEDOM 4.5M SILVER SHALE FADE

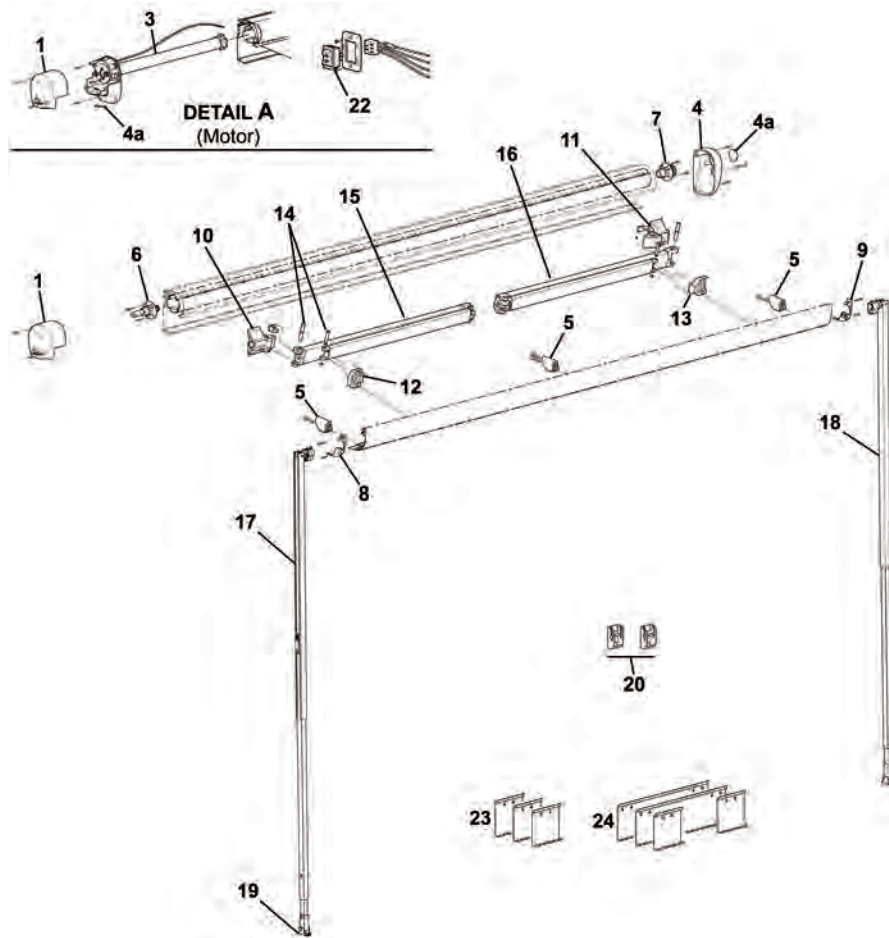

| No. | Carefree Part No. | Coast Part No. | Description |
|-----|-------------------|------------------|---|
| 6 | R001618WHT | 200-38502 | Freedom L/H End Cap Top White |
| 3 | R001637WHT | 200-38500 | Freedom L/H Motor Assy White |
| 4 | R001620WHT | 200-38504 | Freedom R/H End Cap White |
| 4a | R040792-005 | 200-38506 | Freedom Plug White |
| 5 | R001621 | 200-38508 | Freedom Ramp Kit Lead Rail |
| 6 | R001622 | 200-38510 | Freedom L/H Roller Tube End Plug |
| 7 | R001623 | 200-38512 | Freedom R/H Roller Tube End Plug |
| 8 | R001624WHT | 200-38514 | Freedom L/H End Plate Lead Rail White |
| 9 | R001625WHT | 200-38516 | Freedom R/H End Plate Lead Rail White |
| 10 | R001626 | 200-38518 | Freedom L/H Knuckle Assy Case |
| 11 | R001627 | 200-38520 | Freedom R/H Knuckle Assy Case |
| 12 | R001628 | 200-38522 | Freedom L/H Assy Pivot |
| 13 | R001629 | 200-38524 | Freedom R/H Assy Pivot |
| 14 | R001630 | 200-38526 | Freedom Hardware Pack Arm Attach - 1 Arm |
| 15 | R012530-TB76L | 200-38528 | Freedom L/H Spring Arm Assy - Used with 2.57m |

| | | | |
|----|---------------|------------------|--|
| | R012530-TB94L | 200-38532 | Freedom L/H Spring Arm Assy - Used with 3.0m & Up |
| 16 | R012530-TB76R | 200-38530 | Freedom R/H Spring Arm Assy - Used with 2.57m |
| | R012530-TB94R | 200-38534 | Freedom R/H Spring Arm Assy - Used with 3.0m & Up |
| 17 | R001654-001 | 200-38536 | Freedom L/H Vertical Support Leg - Used with 2.44m & 2.57m |
| | R001654-002 | 200-38540 | Freedom L/H Vertical Support Leg - Used with 3.0m & Up |
| 18 | R001654-101 | 200-38538 | Freedom R/H Vertical Support Leg - Used with 2.44m & 2.57m |
| | R001654-102 | 200-38542 | Freedom R/H Vertical Support Leg - Used with 3.0m & Up |
| 19 | R00394 | 200-38544 | Freedom Carport Foot |
| 20 | R019283-005 | 200-38546 | Freedom Kit Bottom Bracket White |
| 22 | R001605 | 200-38548 | Freedom Switch Kit |
| 23 | R019311-001 | 200-38550 | Freedom Hardware Pack 2.43m to 4.0m |
| 24 | R019311-003 | 200-38552 | Freedom Hardware Pack 4.50m to 5.0m |

STABILUS GAS STRUTS

LIFT-O-MAT gas springs are non-locking gas springs. They are used whenever components must be brought conveniently into a defined end position. A LIFT-O-MAT can control the extension force and damping action depending on the function, ensuring user-friendly motion sequences.

ADVANTAGES AND PROPERTIES

- > Optimised weight compensation during liftings, lowering, opening and closing actions
- > Broad range of sizes and force variants available as standard products.
- > Flat Spring characteristic curve; i.e., low force increase, even with high forces and large strokes
- > Choice of linear, progressive or decreasing spring characteristic curves
- > Compact form factor for installation in small spaces
- > Large variety of end fittings for efficient assembly
- > Dampened adjustment motion over defined ranges or continuously
- > Extension speed control possible



| Part Number | Description |
|-------------|--|
| 250-00202 | STABILUS Gas Strut 315.5mm/50N/120mm Stroke (C5719/No Ball-Studs Inc) |
| 250-00204 | STABILUS Gas Strut 315.5mm/60N/120mm Stroke (C5719A/No Ball-Studs Inc) |
| 250-00206 | STABILUS Gas Strut 315.5mm/150N/120mm Stroke (C5720/No Ball-Studs Inc) |
| 250-00208 | STABILUS Gas Strut 315.5mm/100N/120mm Stroke (C5720B/No Ball-Studs Inc) |
| 250-00210 | STABILUS Gas Strut 315.5mm/250N/120mm Stroke (C5724/No Ball-Studs Inc) |
| 250-00212 | STABILUS Gas Strut 415mm/175N/150mm Stroke (C5718C/No Ball-Studs Inc) |
| 250-00214 | STABILUS Gas Strut (Eyelet) 455mm/200N/180mm Stroke (C2705D/No Ball-Studs Inc) |
| 250-00216 | STABILUS Gas Strut 485mm/250N/200mm Stroke (C5714/No Ball-Studs Inc) |
| 250-00218 | STABILUS Gas Strut 485mm/400N/200mm Stroke (C5714A/No Ball-Studs Inc) |
| 250-00220 | STABILUS Gas Strut 485mm/125N/200mm Stroke (C5715B/No Ball-Studs Inc) |
| 250-00222 | STABILUS Gas Strut 485mm/600N/200mm Stroke (C5715C/No Ball-Studs Inc) |
| 250-00224 | STABILUS Gas Strut 485mm/200N/200mm Stroke (C5718/No Ball-Studs Inc) |
| 250-00226 | STABILUS Gas Strut 485mm/280N/200mm Stroke (C5724A/No Ball-Studs Inc) |
| 250-00228 | STABILUS Gas Strut 501mm/100N/200mm Stroke (C5718D/No Ball-Studs Inc) |
| 250-00230 | STABILUS Gas Strut 525mm/200N/220mm Stroke (C5718A/No Ball-Studs Inc) |
| 250-00232 | STABILUS Gas Strut 525mm/150N/220mm Stroke (C5720A/No Ball-Studs Inc) |
| 250-00234 | STABILUS Gas Strut 585mm/300N/250mm Stroke (C5703Z/No Ball-Studs Inc) |
| 250-00236 | STABILUS Gas Strut 585mm/250N/250mm Stroke (C5723/No Ball-Studs Inc) |
| 250-00238 | STABILUS Gas Strut 825mm/330N/354mm Stroke (C5702/No Ball-Studs Inc) |
| 250-00240 | STABILUS Gas Strut 825mm/240N/354mm Stroke (C5703/No Ball-Studs Inc) |
| 250-00242 | STABILUS Gas Strut 825mm/290N/354mm Stroke (C5704/No Ball-Studs Inc) |
| 250-00244 | STABILUS Gas Strut 825mm/435N/354mm Stroke (C5715/No Ball-Studs Inc) |
| 250-00246 | STABILUS Gas Strut 825mm/500N/354mm Stroke (C5715A/No Ball-Studs Inc) |
| 250-00248 | STABILUS Gas Strut 825mm/600N/354mm Stroke (C5728/No Ball-Studs Inc) |
| 250-00250 | STABILUS Gas Strut 825mm/630N/354mm Stroke (C5741/No Ball-Studs Inc) |
| 250-00252 | STABILUS Gas Strut 902.5mm/525N/400mm Stroke (C5710E/No Ball-Studs Inc) |
| 250-00254 | STABILUS Gas Strut 195mm/200N/60mm Stroke (C5718B/No Ball-Studs Inc) |
| 250-00256 | STABILUS Gas Strut 195.5mm/350N/60mm Stroke (C5722/No Ball-Studs Inc) |
| 250-00258 | STABILUS Gas Strut 375mm/50N/150mm Stroke (C5725/No Ball-Studs Inc) |
| 250-00260 | STABILUS Gas Strut 825mm/700N/354mm Stroke (C5727/No Ball-Studs Inc). |

CARAVAN BED FRAMES



Made from lightweight aluminium (which is 30% lighter than a standard steel bed frame), the Coast Bed Frames are designed in Australia. Their frame is powder coated in a neutral colour (stone beige) to compliment any RVs interior. Slats are made of sturdy European birch timber which is not a hard wood; it therefore offers more flexibility, making it more resilient to breaks. The slats have a textured finish on the side that makes contact with an applied mattress – this reduces shifting caused by movement. The slats are attached to the frame by means of rubber boots which are more flexible than the polypropylene alternative (as harder plastics tend to crack and split over time due to movement). Comes with a 1 year manufacturer's warranty on the frame.

250-00300
CARAVAN BED FRAME ALUMINIUM PRINCE
SPLIT HEAD

Specifications

Dimensions (open): 1450W x 1580L (mm)

Dimensions (closed): 1450W x 1400L (mm)

Weight: 13.5kg

250-00302
CARAVAN BED FRAME ALUMINIUM DOUBLE
SPLIT HEAD

Specifications

Dimensions (open): 1325W x 1580L (mm)

Dimensions (closed): 1325W x 1400L (mm)

Weight: 12.5kg



150-00200

POP TOP INSERT BOWS

These curved bows slide into most pop top vinyl sleeves to ensure the vinyl or canvas folds in when the roof is lowered. They extend up to 255mm in length.



CANOPY LIFT MECHANISMS (FLAT)

A flat 'scissor' style canopy lifter which raises the roof on a pop-top or campervan. They are made of a steel track on the bottom and top sections, as well as two flat steel lengths that form an 'X' and pivot in the centre. Available in two lengths.

250-00500

CANOPY LIFT MECHANISM STANDARD TENSION SPRING

Specifications
Width: 900mm
Lift Height: 685mm
Weight Rating: 40kg



250-00510

CANOPY LIFT MECHANISM STANDARD TENSION SPRING

Specifications
Width: 700mm
Lift Height: 560mm
Weight Rating: 35kg



250-00520

CANOPY LIFT MECHANISM (TUBULAR)

A tubular 'scissor' style canopy lifter which raises the roof on a pop-top or campervan. It is made of a steel track on the bottom and top sections, as well as two tubular steel lengths that form an 'X' and pivot in the centre.

Specifications
Width: 900mm
Lift Height: 685mm



250-00530

CANOPY LIFT MECHANISM 1200MM

A flat 'scissor' style canopy lifter which raises the roof on a pop-top or campervan. It is made of a steel track on the bottom and top sections, as well as two steel lengths that form an 'X' and pivot in the centre.

Specifications
Width: 1200mm
Lift Height: 990mm
Weight Rating: 35kg



CANOPY EASY LIFT ARMS

Canopy easy lift arms (pair), made from 16mm square tube steel with a wall thickness of 1.2mm.

- > White powder coat finish
- > Sold per pair

250-00546

CANOPY EASY LIFT ARMS – SMALL

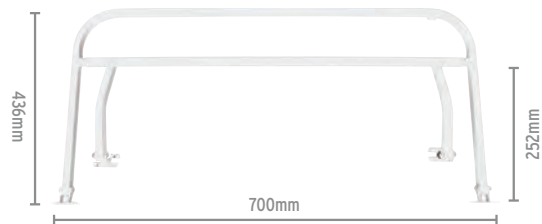

250-00548

CANOPY EASY LIFT ARMS – LARGE

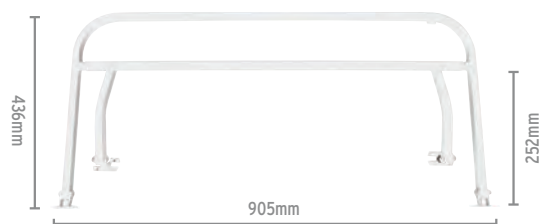

250-00544

CANOPY EASY LIFT ARMS – SILVER LATCH



ROOF CLAMP FOR POP TOPS**250-00552****ROOF CLAMP FOR POP TOP
- WHITE**

(2 Part kit)

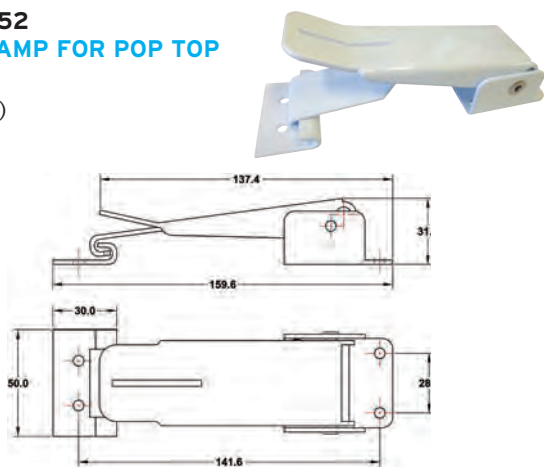
**250-00554****ROOF CLAMP WITH J HOOK
FOR POP-TOP BLACK**

Essential for all pop tops, these roof clamps secure the roof in the lowered position whilst in travel. Comes as a 2-part kit, a clamp & small J bracket.

**250-00560****J HOOK FOR WHITE
POP-TOP CLAMP****250-00602****ROOF CLAMP FOR POP-TOP
- SILVER**

(2 Part kit)

**250-00610****J HOOK FOR SILVER POP
TOP CLAMP****250-00620****LOCKABLE ROOF CLAMP FOR
POP-TOP - SILVER**

Allows you to lock your pop top roof in the closed position by using a padlock. (Padlocks are not included).

**200-08038****COAST POP TOP SUPPORT - WHITE**

Give your pop top roof support when it is in the open position. Its telescopic mechanism makes it easy to use, and once the appropriate height is achieved, a simple twist locks it in position. Made from an aluminium tube with rubber caps on each end for a

Specifications

Closed Length: 34cm

Max Open Length: 50cm

**250-03000****3 STAGE CAMPER LIFTER WITHOUT WINGS**

Once you have successfully opened your Jayco camper trailer these lifters act as a support to keep your camper trailer in the 'open' position.

Specifications

Compacted ext: 770mm

Maximum ext: 2047mm

**250-03100****COAST CAMPER ROOF SUPPORT POLE**

Coast Camper Roof Support Poles are designed to provide additional support for your camper's roof. Perfect for when your roof is up for long periods of time or if you have added additional load to your roof such as an awning. This product has the following great features:

- > Made from white powder coated lightweight aluminium
- > Rubber end caps for a non-slip fit
- > Can be trimmed down to suit a range of RVs.

Specifications

Length: 1500mm

Width: 22mm

Length with Rubber End Caps: 1525mm

Rubber End Cap Width: 35mm

**250-03009****CAMPER LIFTER
CHANNEL DOOR**

Door and surround to suit Jayco camper lifter channels.



ALUMINIUM EXTRUSION

SECTION

250-03010

PUSH RODS 66"

These strong, flexible push rods guide the roof of your camper trailer upwards as you wind the crank. They help to push the lifter arm up.



250-02008

**TRULINE FLAT ALUMINIUM
BLACK 31MM X 4.8M**



PLASTIC BED SADDLES

250-03020

**PLASTIC BED
SADDLE TO
SUIT CAMPER**

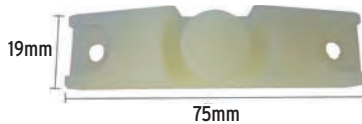

250-02010

**TRULINE ALUMINIUM WHITE
(J MOULD - NARROW)
22MM X 4.8M**



TRULINE ALUMINIUM

250-02000

TRULINE ALUMINIUM WHITE 5M

Also known as Millard Series 80 Aluminium. This is a powder coated aluminium edging used to seal the joints of the exterior of your RV e.g. where the side wall meets the roof or the rear panel. (Has a 25mm lip to cover the roof or front/ rear).



250-02012

**TRULINE ALUMINIUM
BLACK (J MOULD -
NARROW) 22MM X 4.8M**

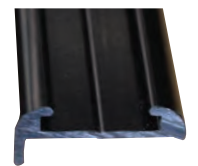

250-02014

**TRULINE FLAT ALUMINIUM
WHITE (NARROW)
22MM X 4.8M**

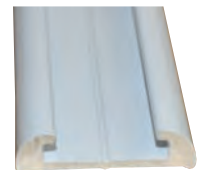

250-02002

**TRULINE ALUMINIUM
CUSTOM MATT BLACK 5M**

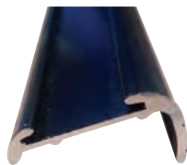

250-02016

**TRULINE FLAT ALUMINIUM
BLACK (NARROW)
22MM X 4.8M**

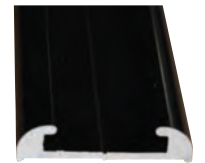

250-02004

**TRULINE CLEAR ANODISED
5M**

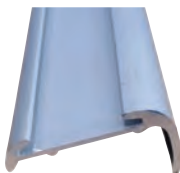

MOULD INSERT FOR 22MM TRULINE

Used mostly in the manufacturing process to cover external screw points and give an overall neater appearance. Available with an 18mm width.

250-02126

WHITE MOULD INSERT 100M ROLL

250-02136

WHITE MOULD INSERT 300M ROLL



250-02006

**TRULINE FLAT ALUMINIUM
WHITE 31MM X 4.8M**

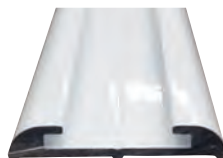

250-02127

BLACK MOULD INSERT 100M ROLL

250-02137

BLACK MOULD INSERT 300M ROLL

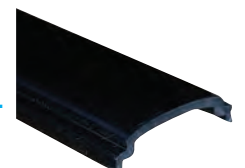

MOULD INSERT FOR 31MM TRULINE

Fits inside the Truline Aluminium to cover up any unsightly screws.

250-02128
WHITE MOULD INSERT
100M ROLL



250-02138
WHITE MOULD INSERT
250M ROLL

250-02130
BLACK MOULD INSERT
100M ROLL



250-02140
BLACK MOULD INSERT
250M ROLL

SAILTRACK

A solution to fixing one end of your roll out awning to the wall of your RV or the roof of your pop top. Alternatively, mount these vertically onto the walls of your RV enabling you to install an annexe room. Drilling is required to attach to the wall of the RV. Comes in two colours.

200-08100
SAILTRACK SINGLE SIDED
6M MILL FINISH

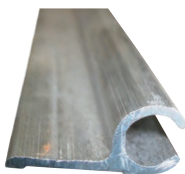

200-08102
SAILTRACK DOUBLE
SIDED 6M MILL FINISH

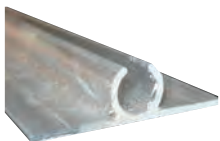

200-08104
SAILTRACK SINGLE SIDED
6M WHITE

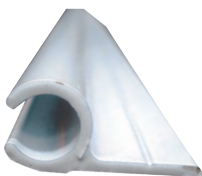

200-08105
SAILTRACK SINGLE SIDED
6M BLACK



200-08106
SAILTRACK DOUBLE
SIDED 6M WHITE



200-08107
SAILTRACK DOUBLE
SIDED 6M BLACK



200-08110
SAILTRACK SINGLE SIDED
4.3M WHITE

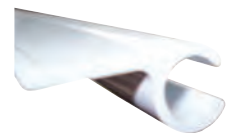

200-08112
SAILTRACK DOUBLE
SIDED 4.3M WHITE

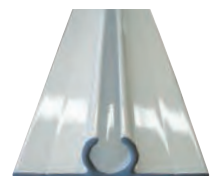

200-08129
TOP FIX CURTAIN TRACK
5M (MILL FINISH)

An anodised aluminium curtain track that comes pre drilled. Runners are not included.

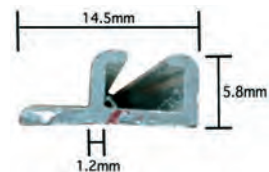

COAST ALUMINIUM CLADDING

COAST CP10 - DEEP VIOLETONE

SPECIFICATIONS

Sheet Thickness: 0.55mm
Tolerance: 3005, H44 temper
Top Finish: Polyester paint (25um thick) with and 80% applied.

Bottom Finish: Grey primer paint (5-7um thick)

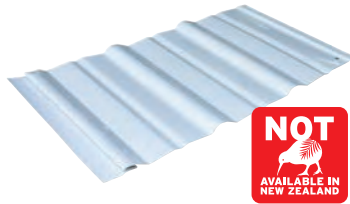

| Part Number | Description |
|-------------|---|
| 250-01130 | ALUMINIUM SIDE CLADDING 6.1 X 0.315 Coast CP10 DEEP VIOLETONE WHITE.NO Plastic Film |
| 250-01140 | ALUMINIUM SIDE CLADDING 7.3 X 0.315 Coast CP10 DEEP VIOLETONE WHITE.NO Plastic Film |
| 250-01150 | ALUMINIUM SIDE CLADDING 8.0 X 0.315 Coast CP10 DEEP VIOLETONE WHITE.NO Plastic Film |
| 250-01160 | ALUMINIUM SIDE CLADDING 7.3 X 0.315 Coast CP10 CRYSTAL SILVER. NO Plastic Film |

COAST CPSF10 - SHALLOW VIOLETONE



| Part Number | Description |
|-------------|--|
| 250-01230 | ALUMINIUM SIDE CLADDING 6.1 X 0.315 Coast CPSF10 SHALLOW PROFILE V/WHITE.NO Plastic Film |
| 250-01240 | ALUMINIUM SIDE CLADDING 7.3 X 0.315 Coast CPSF10 SHALLOW PROFILE V/WHITE.NO Plastic Film |
| 250-01250 | ALUMINIUM SIDE CLADDING 7.3 X 0.315 Coast CPSF10 SHALLOW PROFILE V/WHITE.NO Plastic Film |
| 250-01260 | ALUMINIUM SIDE CLADDING 7.3 X 0.315 Coast CPSF10 CRYSTAL SILVER. NO Plastic Film |

COAST NF10

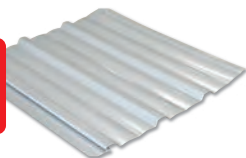

| Part Number | Description |
|-------------|--|
| 250-01270 | ALUMINIUM SIDE CLADDING 7.3 X 0.315 Coast NF10 WHITE. NO Plastic Film |
| 250-01272 | ALUMINIUM SIDE CLADDING 8.0 X 0.315 Coast NF10 WHITE. NO Plastic Film |
| 250-01280 | ALUMINIUM SIDE CLADDING 7.3 X 0.315 Coast NF10 SILVER GLASS. NO Plastic Film |
| 250-01282 | ALUMINIUM SIDE CLADDING 8.0 X 0.315 Coast NF10 SILVER GLASS. NO Plastic Film |

COAST CP48



| Part Number | Description |
|-------------|--|
| 250-01320 | ALUMINIUM ROOF SHEETING. 2.44 x 1.22 MT. Coast CP48. V/WHITE.NO Plastic Film |
| 250-01350 | ALUMINIUM ROOF SHEETING. 2.44m x 1.22m STUCCO Coast CP48 no plastic film WHITE |

COAST CPF3



| Part Number | Description |
|-------------|--|
| 250-01330 | ALUMINIUM ROOF SHEETING. 2.44 x 1.22 MT. Coast CPF3. V/WHITE.NO Plastic Film |
| 250-01360 | ALUMINIUM ROOF SHEETING. 2.44m x 1.22m STUCCO Coast CPF3 no plastic film WHITE |

TAPE FOAM PVC SEALING

This general purpose foam tape is manufactured for use in applications requiring positive seals on irregular surfaces or when flex and conformability to tight radius curves are critical considerations.



- > Low density foam is easy to compress and conformable, but is still strong and resilient
- > Insulates against temperature, sound and vibration
- > Formulated from durable Poly Vinyl Chloride (PVC) for long service life.
- > Closed cell structure completely seals out air, moisture, light and dust when compressed at least 30%.

250-02500
GREY 6.4MM THICK
X 12MM X 15.2M

250-02501
BLACK 6.4MM THICK
X 12MM X 15.2M

250-02502
GREY 9.5MM THICK
X 12MM X 7.0M

250-02503
BLACK 9.5MM THICK
X 12MM X 7M

250-02504
GREY 12.7MM THICK
X 12MM X 7.0M

250-02505
BLACK 12.7MM THICK
X 12MM X 7M

250-02506
GREY 6.4MM THICK
X 18MM X 15.2M

250-02507
BLACK 6.4MM THICK
X 18MM X 15.2M

250-02508
GREY 9.54MM THICK
X 18MM X 7.0M

250-02509
BLACK 9.5MM THICK
X 18MM X 7M

250-02510
GREY 12.7MM THICK
X 18MM X 7.0M

250-02511
BLACK 12.7MM THICK
X 18MM X 7M

THE LIPPERT RANGE



Exclusively available through Coast to Coast, Lippert present their ready-to-use in Wall Slide Out Systems, allowing Australian manufacturers to provide more living space to RV consumers without compromising overall size.

In order to provide greater flexibility, improved aesthetics and pricing, Lippert Slide Out Systems are no longer sold in kits. Individual components can now be ordered to suit your specific requirements and a list of parts and required quantities is now available.

For your convenience it is still possible to order all the components that make up each of the superseded kits. Just let your friendly Coast to Coast sales team know the kit number and quantity required and we'll handle the rest.

DURABLE AND CORROSION RESISTANT

Lightweight anodised aluminum resists rust better than systems with chains, cables and exterior mounting brackets.

MORE SPACE

Slide-Out mechanism fits inside the wall cavity leaving significantly more interior space. Other bulky systems require a slide room fascia to cover motor and pulleys.

LEAK FREE

The 50/50 power split ensures both slide room sides properly compress seals. Independent side control allows different stroke lengths to compensate for bulb seals setting or wearing down unequally.

LIGHTWEIGHT

Lightest slide system on the market keeps overall RV weight down.

NO ADJUSTMENTS

The In-Wall Slide-Out System never needs complicated adjustments.

SMART CONTROL TECHNOLOGY

Smart system continually monitors motors for safe operation, and stops the slide-out if an issue is detected.

SPECIFICATIONS

- > Each Slide Out System (per side) consists of: x1 Motor Drive, x2 Drive Gears and x1 Torque Shaft
- > Can be installed on RVs with a wall thickness of 25-38mm
- > Has a manual override function
- > Switch is mounted internally (to move room in or out)

Slide Out Room Kit 1 1478mm-610mm

Slide Out Room Kit 2 1578mm-610mm

Slide Out Room Kit 3 1678mm-610mm

Slide Out Room Kit 4 1478mm-910mm

Slide Out Room Kit 5 1578mm-910mm

Slide Out Room Kit 6 1678mm-910mm

Slide Out Room Kit 7 1978mm-910mm

Slide Out Room Kit 8 1813mm-910mm



| CTC P/N | DESCRIPTION | QTY | UNIT | NOTE | D-SEAL METRE |
|--|--|-----|--------|--------------------------|--------------|
| SLIDE OUT H COLUMN AND RACK | | | | | |
| 250-05031 | Lippert Slide Out H Column and Rack Only. 1478mm-610mm. V000293019 | | ea | 1 per Kit | 14 |
| 250-05033 | Lippert Slide Out H Column and Rack Only. 1578mm-610mm. V000293020 | | ea | | 14 |
| 250-05035 | Lippert Slide Out H Column and Rack Only. 1678mm-610mm. V000293021 | | ea | | 15 |
| 250-05037 | Lippert Slide Out H Column and Rack Only. 1478mm-910mm. V000299431 | | ea | | 14 |
| 250-05039 | Lippert Slide Out H Column and Rack Only. 1578mm-910mm. V000299432 | | ea | | 14 |
| 250-05041 | Lippert Slide Out H Column and Rack Only. 1678mm-910mm. V000299433 | | ea | | 15 |
| 250-05043 | Lippert Slide Out H Column and Rack Only. 1978mm-910mm. V000317788 | | ea | | 16 |
| 250-05045 | Lippert Slide Out H Column and Rack Only. 1813mm-910mm. V000323782 | | ea | | 15 |
| 250-05047 | Lippert Slide Out H Column and Rack Only. 911mm-889mm. V000355073 | N/A | | | 12 |
| CONTROLLER | | | | | |
| 250-05100 | Slide Out Room Controller. 211852 | | ea | 1 per Kit | |
| HARNESS | | | | | |
| 250-05152 | Lippert Slide Out 20' (6096mm) Harness for Controller to Motor. 229755 | | ea | 2 per Kit | |
| SWITCH | | | | | |
| 250-05156 | Switch (40 amp) with 4 Wire Pigtail for Slide-Out. 0187505 | | ea | 1 per Kit | |
| EXTERIOR T MOLD AND T MOLD COVERS (BLACK/WHITE) | | | | | |
| 250-05162 | Aluminium T-Mold 1801 15' (4572mm) Black (Hole Punched). 0713833 | | ea | 3 per Kit | |
| 250-05164 | Aluminium T-Mold 1801 15' (4572mm) Polar White (Hole Punched). 0713834 | | ea | 3 per Kit | |
| 250-05166 | Plastic Corner Cover for Aluminium T-Mold White "700". 0713867 | | ea | 4 per Kit | |
| 250-05168 | Plastic Corner Cover for Aluminium T-Mold Black "700". 0713866 | | ea | 6 per Kit | |
| 250-05170 | Aluminium Angle 40mm x 25mm x 3mm x2400mm | | ea | 3 per Kit | |
| RUBBER SEAL AND CORNER CUP SEAL | | | | | |
| 250-05172 | Top Double Wiper Seal Black in 15' (4572mm) Length. 0713831 | | ea | 1 per Kit | |
| 250-05174 | Bottom Single Wiper Seal Black in 15' (4572mm) Length. 0713836 | | ea | 1 per Kit | |
| 250-05180 | Rubber "D" Seal Black (Sold per Metre). 0713835 | | Metres | Refer to "D-Seal" Column | |
| 250-05176 | Bottom Right Hand Corner Cup Seal Black. 0217506 | | ea | 1 per Kit | |
| 250-05178 | Bottom Left Hand Corner Cup Seal Black. 0217505 | | ea | 1 per Kit | |
| FLOOR ROLLER | | | | | |
| 250-05158 | Slide Out Room Roller & Bracket 26mm. 217900 | | ea | 6 per Kit | |

Handwriting practice area with 25 horizontal dotted lines.

A series of horizontal dotted lines for writing notes.

SECTION 2

CAMPING EQUIPMENT

(Product Group - 300)

| | |
|--|-----------|
| Camping Accessories | 060 - 063 |
| Coast Fire Pits | 064 |
| Collapsible Homeware | 065 |
| Palm Drinkware and Kitchen Accessories | 066 - 070 |

CAR ACCESSORIES

(Product Group - 350)

| | |
|------------------------------|-----------|
| Towing Accessories | 070 - 074 |
| Towing Mirrors | 074 - 076 |
| Brake Controllers | 077 - 079 |
| CURT Towing Accessories | 079 - 082 |
| Tyre Pressure Monitoring | 083 |
| Lippert Swap Command Kit | 084 |
| Quick Fit Bike Racks | 085 - 086 |
| Carry Bikes and Accessories | 087 - 090 |
| Hayman Reese Hitches | 091 - 092 |
| Eaz Lift WDH and Accessories | 093 - 096 |
| Tips For Safer Towing | 097 - 098 |
| Throttle Controllers | 99 |
| E-Bikes | 100 |



COAST BLUE CAMP FURNITURE

300-00910

COAST BLUE CAMP CHAIR WITH SIDE BAG & TABLE - 120KG RATED

- > Folds down to a compact size for easy storage and carrying.
- > Come with high quality storage bag with carry handles and zips.
- > Features a locking mechanism for safety and stability.
- > Folding side table with cup holder and hanging storage bag.
- > Loading capacity: 120KG.



SPECIFICATIONS

Dimensions: 54x45x46/92

Frame: Φ 22mm, 30x15mm steel tube/powder coating

Material: 600D polyester/PVC coating

300-00912

COAST BLUE PADDED HI-BACKED CHAIR - 120KG RATED

- > 120kgs max loading capacity.
- > Folds down to a compact size for easy storage and carrying.
- > Features a comfortable foam padded seat, headrest and backrest.
- > Fabric covers on aluminium armrest.
- > Lumbar support.
- > Invisible pocket on the top for carry bag storage.
- > Two side pockets.



SPECIFICATIONS

Dimensions: 65x45x50/95

Frame: Φ 22mm steel tube/powder coating Armrest: 55*22mm Alu/powder coating

Material: 600D polyester/PVC coating

300-00920

COAST BLUE COLLAPSIBLE CAMP CUPBOARD - 30KG RATED

- > Dual sided three-shelf flat folding cupboard.
- > Matt finished cupboard top can be used as a convenient table
- > Quick and easy to assemble in seconds, mesh rear to ventilation.
- > Easily folded into and packing away for carrying and storage.
- > Carry bag included.
- > Loading capacity: 30KG



SPECIFICATIONS

Dimensions: 84x50x80cm

Frame: Φ 19mm Alu. Tube/matt finish

Material: 600D polyester/PVC coating

300-00922

COAST BLUE TAILGATE CAMP TROLLEY - 100KG RATED

- > Multipurpose folding camp trolley with storage pockets
- > Carry all your gear to the camping or picnic spot with ease.
- > Rear of trolley folds down to accommodate oversized items
- > Tailgate doubles as a table with 2 cup holders.
- > Adjustable long handle to pull and direct the trolley with ease.
- > Large, lightweight wheels allow you to navigate almost any terrain.
- > Foldable to compact size for easy carrying and storage.
- > Carry bag included.
- > Loading capacity: 50KG



SPECIFICATIONS

Dimensions: 98.5x49x58cm

Frame: Φ 19mm, 25x12mm, 20x10mm steel tube/powder coating

Material: 600D polyester/PVC coating

300-00930

COAST BLUE CAMP SHOE RACK - ORGANIZER BAG

- > Large hanging storage and organisation rack
- > 10 large storage compartments that are perfect for shoes and other belongings to keep them high and dry.
- > Large carry handle, reinforced eyelets and straps with fasteners for multiple hanging solutions.
- > Full storage compartment covering with dual zippers and storage clips



SPECIFICATIONS

Dimensions: 86x48x18

Material: 600D polyester/PVC coating

300-00932

COAST BLUE TENT TIDY - VERTICAL ORGANIZER BAG

- > Vertical hanging storage bag for organising your belongings, keeping them clean and safe.
- > 8 small pockets (10w x 14h) 6 medium pockets (15w x 14h) and 2 large pockets (22w x 17h)
- > Reinforced eyelets and looped straps for multiple hanging solutions.



SPECIFICATIONS

Dimensions: 123x47x15

Material: 600D polyester/PVC coating

CAMCO CAMPING ESSENTIALS

300-00100

RV COLLAPSIBLE BUCKET

Made from a rugged and watertight material, this bucket is the perfect size for RVing, camping and fishing. With an 11L capacity and opening up to 23.5cm tall, it takes up minimal storage space by folding to a compact 3.5cm when not in use. Comes with a convenient zippered storage bag.



300-01114

FOLDING SHOVEL

Length: 61cm
Folds to: 24cm



300-01124

VINYL TABLECLOTH

Has rounded edges and an easy to clean waterproof surface.

Dimensions: 132W x 213L (cm)



300-01100

LANTERN HANGER

Helps to keep bugs up and away from your campsite (lantern not included).



300-01108

12 EGG CARRIER



COAST TIE DOWN RANGE

200-08019
COAST PREMIUM AWNING
TIE DOWN KIT

The ultimate tie down kit to keep your awning safe and secure! It can help prevent damage to your awning caused by high winds and comes with screw-in-pegs that can quickly be driven into the ground with ease thanks to the Power Drill Adaptor Socket.

**INCLUDES:**

- > 2 x Large Alloy Screw In Peg 300mm
- > 2 x ABS Guy Rope Holders
- > 1 x Alloy Screw In Peg Power Drill Adaptor Socket 17mm
- > 2 x Reflective Glow Guy Rope with Spring and Runner
- > 2 x Tie Down Awning Clamps Stainless Steel

300-01200
LARGE ALLOY SCREW IN PEG
WITH ABS GUYROPE HOLDER
CLIP

- > The screw action grips into the soil for a safe and secure guy rope tie down point
- > Comes complete with a guy rope holder clip to tie down your awning quickly and easily
- > Designed to suit the Power Drill Adaptor Socket (sold separately) that allows the screw to be quickly driven into the ground with ease

**300-01209**
ALLOY SCREW IN PEG
POWER DRILL ADAPTOR
SOCKET

- > Designed to suit large alloy screw in pegs
- > Power Drill Adaptor Socket 17mm

**300-01210**
STD GUY ROPE SPRUNG
WITH ALUM HANDLE - 2.6M

Complete with aluminium handle and heavy-duty spring, these guy ropes will keep the tension on awnings, gazebos, tent poles etc.

- > 6mm rope 2.6m long
- > Heavy duty spring
- > Aluminium runner

**300-01212**
REFLECTIVE GLOW GUY ROPE
SPRUNG WITH ALUM HANDLE
- 3.5M

No more tripping and stumbling around the campsite at night with this reflective glow in the dark guy rope.

Complete with aluminium handle and heavy-duty spring, these guy ropes will keep the tension on awnings, gazebos, tent poles etc.

- > 6mm Reflective glow in the dark rope 3.5m long
- > Heavy duty spring
- > Aluminium runner

**300-01220**
PAIR OF ROLL OUT AWNING
TIE DOWN CLAMPS

Protect your roll out awning in all conditions with these stainless-steel tie downs. Simply fit over each end of the roller and locate the rear of the awning groove, add your guy ropes to the loops and secure to the ground.



GLO-X POWERLESS ILLUMINATION

Glo-X offers 'powerless illumination' and has been developed using the latest in light recycling technology. Due to its unique properties, Glo-X is ideal for use in areas where power is not readily available, but illumination is required.

300-01451
GLO-X 60MM ROUND MARKER
Glo-X Round Markers can be used for a wide range of applications including trailers, caravans, driveways, night guidance, fishing, boating, camping, post marking and safety markings. Easily attachable by a screw, rivet or bonding.



The Round Markers charge quickly with any form of powered or natural light and then illuminate for 10+ hours depending on light conditions. Applied to stairs or hidden obstacles during low light periods or in the event of a power failure. A Round Marker can add a personal touch of illumination to many products that will set you apart from others.

FULL LUMINANCE EFFECT IS BEST ACHIEVED IN TOTAL DARKNESS.

APPLICATIONS

- > Trailer
- > Guy rope tent peg marker
- > Driveway / letterbox marker
- > Night guidance
- > Fishing, boating
- > Camping
- > Post marking
- > Hazard safety marking

SPECIFICATIONS

Diameter: 60mm
Thickness: 4mm
Centre Hold Diameter: 5mm

300-01456

GLO-X 90 X 55MM SIGN TILE MARKER

Glo-X Sign Marker is easily locatable and encourages way finding and identification in low light situations. The size of a business card, this marker can be personally formatted into any symbol, wording or signage. Can be used for a wide range of applications including caravans, trailers, driveways, night guidance, fishing, boating, camping, emergency and personal identification, instructions and safety markings. The Sign Marker comes with a black marker pen to enable you to personalise the use and application of the signs.

FULL LUMINANCE EFFECT IS BEST ACHIEVED IN TOTAL DARKNESS.

APPLICATIONS

- > Address and name marking
- > Emergency equipment location marking
- > Personal notes
- > Hazard awareness
- > Preventative signage



SPECIFICATIONS

Dimensions: 90 x 55mm
Thickness: 2.5mm

300-01457

GLO-X 42MM ZIP MARKER 4PK

Glo-X Zip Marker will charge quickly with any form of powered or natural light and then illuminate for 10+ hours depending on light conditions.

Glo-X Zip Markers can easily connect to an existing zip. With a wide range of applications available including tents, backpacks, sleeping bags and clothing, this zip marker is essential for use when locating a zipper in a low level light situation as well as being a powerless long lasting personal safety indicator. The Glo-X Zip Marker will charge quickly with any form of powered or natural light and then illuminate for 10+ hours depending on light conditions.

FULL LUMINANCE EFFECT IS BEST ACHIEVED IN TOTAL DARKNESS.

APPLICATIONS

- > Easily clipped onto an existing zip
- > Ideal for use when locating tent zips
- > Perfect for backpacks, clothing and sleeping bag zips

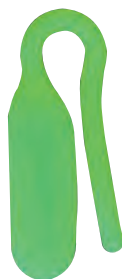

SPECIFICATIONS

Length: 40mm
Height: 10mm
Thickness: 5mm

COAST CAMP N COOLER

300-06000

COAST CAMP N COOLER

The perfect way to store your cold goods when free camping, at the beach or picnicking. The 30L cooler includes dual folding wing tables to hold food and drink, two convenient mini-camp chairs that clip under the table wings and folding carry handles and integrated wheels for easy maneuvering



FEATURES

- > Portable 30L cooler with removable storage tray
- > Folding carry handles and wheels for ease of movement
- > Dual folding wing tables with folding support legs
- > Two folding mini-camp chairs that clip under table wings for easy storage.

SPECIFICATIONS

Folded Size: (L)55cm x (W)37cm x (H)41cm
Extension Size: (L)100cm x (W)55cm x (H)41cm
Chair Weight Rating: 89kg
Chair Size: (H)26cm x (W)24cm x (D)22cm
Weight: 9kg

COAST FIRE PITS



Enjoy the cooler weather with the Coast to Coast Firepit. This portable steel firepit folds up for easy storage and allows you to setup a safe and cosy campfire in no time at all. Assembly requires no tools and takes just seconds, so you can enjoy the warmth of a fire without the hassle.

Made from 3mm BlueScope steel it comes standard with a 1.6mm Galvanised ember tray, optional grill and hot plate also available. The Coast Firepit is CNC Laser cut to precision for a perfect press fit assembly in seconds.

FEATURES

- > Made from 3mm BlueScope steel
- > Perfect for the campsite and backyard
- > Laser cut carry handles
- > 1.6mm Galvanised ember tray
- > Assembly in seconds
- > Folds up for easy storage
- > Optional grill and hot plate also available
- > Australian Made

300-06001

COAST STEEL PORTABLE 400MM FIREPIT & EMBER TRAY KIT

300-06004

COAST STEEL GRILL PLATE T/S 400MM FIREPIT

300-06013

COAST STEEL PORTABLE 600MM FIREPIT & EMBER TRAY KIT

300-06014

COAST STEEL GRILL PLATE T/S 600MM FIREPIT



TRAVELLERS TWIN PET BOWL

These travellers pet bowls feature folding legs that lock for space saving storage while on the road and height adjustment when in use.

The frame is made of ABS plastic, the bowls are removable stainless steel and the feet are silicone for grip. The top surface features a handy design that prevents food from spilling over or can be filled with water to create a moat keeping ants from reaching the bowls.

SPECIFICATIONS

Dimensions: (L)370mm x (W)195mm x (H)54mm (folded)
 Bowl diameter ea: 140mm x (H)40mm (500ml)
 Adjustable Height: 54 to 115mm
 Weight: 0.78kg

300-06100 TRAVELLERS TWIN PET BOWL - HEIGHT ADJUSTABLE - BLACK



300-06104 TRAVELLERS TWIN PET BOWL - HEIGHT ADJUSTABLE - GREY



COLLAPSIBLE HOMEWARE

300-02820 COLLAPSIBLE COAST DISH DRAINER

Folding dish rack, food grade. This dish drainer is ideal for all your kitchen straining tasks and its collapsible nature allows for easy, space saving.

SPECIFICATIONS

Dimensions: 368 x 317 x 127 mm



300-09002 ZOOPORANG-BOOMERANG TRI-WING

What flies like a frisbee, but returns like a boomerang? The Zooporang of course! Coupled with its safe technology soft polymer construction, the Zooporang will be a total favourite whilst frolicking about in the outdoors.



SPECIFICATIONS

Material: FOAM
 Height: 10mm
 Diameter: 270mm
 Weight: 22g

300-09004 PORTABLE TABLE TENNIS SET

Sometimes you really just need to drop everything for a spontaneous game of table tennis, but you probably find yourself without an appropriate table tennis table to use. Tragic - we know! But fear no more - with our Instant Table Tennis Game you can turn an ordinary table into hours of table tennis fun in a flash! The kit includes a retractable net that extends up to 1.7m with spring-loaded posts to hold firmly in position.



FEATURES:

- > Collapsible Net 1700mm (150mm H)
- > Spring-Clamp Net Support Posts
- > Includes Two Paddles & Two Ball
- > Maximum Table Thickness: 50mm

300-09008 TABLE TENNIS BALLS PK6. GH1163



300-09006 QUADCOPTER R/C WIFI FPV 720P DRONE - 2.4GHZ

Watch a live video feed from the high-definition camera onboard this agile remote-controlled drone as it flies in the sky above. The front facing 720p camera can be adjusted 60° from the remote control to provide a first-person view (FPV) on your Smartphone via Wi-Fi from up to 60m away.



FEATURES:

- > Free iOS™ & Android App
- > Headless & Altitude Hold Mode
- > Return Home
- > One-Key Take Off & Landing
- > 720p (1280 x 720) Camera @ 20fps
- > 60° Adjustable Camera Angle

Remote control aircraft must be used in accordance with local regulations

300-09012**R/C CAR WITH 1080P CAMERA & VR GOGGLES - 1:16**

Get a first-person view (FPV) as you drive this rugged-looking remote controlled car around your house or backyard. Supplied with a phone bracket and VR goggles to fit most Smartphones, you can stream live vision from the 1080p camera mounted on top of the car. There is an app to control or view the car and a microSD card slot to record footage from the camera.

**FEATURES:**

- > VR goggles and a USB charging cable.
- > 1080p Camera
- > VR & Phone Holder Mode
- > Free App For iOS® & Androids

POLYSAFE DRINKWARE

Polysafe drinkware is guaranteed not to crack or shatter, is microwave, dishwasher and campsite safe and has a comfortable drinking lip. An economical solution in a classic design.

300-03000**VINO BLANCO GOBLET (250ML)****300-03002****CHAMPAGNE FLUTE (170ML)****300-03004****JASPER HIGHBALL TUMBLER (425ML)****300-03006****ESPRESSO CUP (250ML)****300-03008****JASPER HIGHBALL TUMBLER (285ML)****300-03010****DOUBLE JASPER TUMBLER (375ML)****300-03014****SPARKLING FLUTE (180ML)****300-03016****COLINS TUMBLER (270ML)****300-03018****COLINS TUMBLER (335ML)****300-03020****COLINS TUMBLER (425ML)**

PALM PRODUCTS

Marc Newson Tritan Drinkware Collection

The Marc Newson Tritan Drinkware Collection is the result of a collaboration between designer Marc Newson, described as the most influential designer of his generation and the engineering and production skills of Robert Wilson and his team at Palm Products.

Their objective was to create the world's finest range of unbreakable drinkware which boasts the following features:

- > Guaranteed unbreakable and dishwasher safe for 10 years in private use and one year in commercial use.
- > Superior dishwasher stability - the drinkware will not crack, break, scratch or go grey and will resist staining.
- > Non-slip base aids stability and acts as a coaster, protecting surfaces.
- > Stable, shorter shapes with well-weighted, wide bases.
- > Tumblers stack securely, saving space and preventing damage.

300-03600
WHISKY CUP WITH CLEAR BASE 285ML

300-03602
HIGHBALL CUP WITH CLEAR BASE 425ML



300-03608
WHISKY CUP WITH WHITE NONSLIP BASE 285ML

300-03610
HIGHBALL CUP WITH WHITE NONSLIP BASE 425ML

300-03612
WINE GLASS WITH WHITE NONSLIP BASE 300ML



300-03616
WHISKY CUP WITH BLACK NONSLIP BASE 285ML

300-03618
HIGHBALL CUP WITH BLACK NONSLIP BASE 425ML



300-03624
WHISKY CUP WITH BLUE NONSLIP BASE 285ML

300-03626
HIGHBALL CUP WITH BLUE NONSLIP BASE 425ML

300-03628
WINE GLASS WITH BLUE NONSLIP BASE 300ML



300-03632
WHISKY CUP WITH GREEN GLOW IN DARK NONSLIP BASE 285ML

300-03634
HIGHBALL CUP WITH GREEN GLOW IN DARK NONSLIP BASE 425ML



300-03640**WHISKY CUP WITH VIVID BLUE NONSLIP BASE 285ML****300-03642****HIGHBALL CUP WITH VIVID BLUE NONSLIP BASE 425ML****300-03648****WHISKY CUP WITH CADMIUM ORANGE NONSLIP BASE 285ML****300-03650****HIGHBALL CUP WITH CADMIUM ORANGE NONSLIP BASE 425ML****SORONA PLATE AND BOWL RANGE**

Sorona plates and bowls are guaranteed unbreakable in normal use. They are dishwasher and microwave safe as well as scratch and stain resistant. The collection stacks securely and efficiently for transport and storage. The sizes fit in typical galleys and RVs and are a suitable size for outdoor use.

- > The materials used are able to withstand dishwasher temperatures and chemicals.
- > Microwave Safe for Reheating
- > The tough surface is highly scratch and stain resistant.
- > High quality, safe, approved for food contact and sustainable.

300-03656**BOWL WITH BLACK NONSLIP BASE 15CM****300-03658****MEDIUM PLATE WITH BLACK NONSLIP BASE 21CM****300-03660****LARGE PLATE WITH BLACK NONSLIP BASE 25CM****300-03662****BOWL WITH NAVY NONSLIP BASE 15CM****300-03664****MEDIUM PLATE WITH NAVY NONSLIP BASE 21CM****300-03666****LARGE PLATE WITH NAVY NONSLIP BASE 25CM****300-03668****BOWL WITH VIVID BLUE NONSLIP BASE 15CM****300-03670****MEDIUM PLATE WITH VIVID BLUE NONSLIP BASE 21CM****300-03672****LARGE PLATE WITH VIVID BLUE NONSLIP BASE 25CM**

300-03674

BOWL WITH ORANGE NONSLIP BASE 15CM

300-03676

MEDIUM PLATE WITH ORANGE NONSLIP BASE 21CM

300-03678

LARGE PLATE WITH ORANGE NONSLIP BASE 25CM



THE PALM CAFFE CUP

The Palm Caffe Cup has a beautiful, tactile design and many distinctive features:

- > A leak-proof lid which clicks open and closed with a simple push.
- > The lid has a ceramic feel and both the cup and lid area are made from a non-absorbent material eliminating stains and odours.
- > A handy window showing how much is left in your cup
- > The cup and lid click apart for easy and thorough cleaning.
- > Dishwasher and microwave safe.
- > Allows a natural drinking action- the lid allows the liquid to flow as it would from a cup and has a wider opening for other contents such as a soup.
- > Non-slip base and low centre of gravity for stability.

300-03680

MEDIUM CAFFE CUP BLACK WITH NONSLIP BASE 300ML

300-03682

MEDIUM CAFFE CUP VIVID BLUE WITH NONSLIP BASE 300ML

300-03684

MEDIUM CAFFE CUP ORANGE WITH NONSLIP BASE 300ML

300-03686

MEDIUM CAFFE CUP PURPLE WITH NONSLIP BASE 300ML



PALM TRITAN ALFRESCO DRINKWARE

Guaranteed unbreakable—made from super-tough BPA-free Tritan—this range of drinkware has the clarity of glass and dishwasher safe for 10 years.

300-03688

WHISKY CUP CLEAR 450ML

300-03690

HIGHBALL CUP CLEAR 550ML



PALM TRITAN HIKING DRINKWARE

The Tritan Hiking range from Palm is designed for easy storage and transport. Guaranteed unbreakable and dishwasher safe for 10 years (private use). This range is the perfect choice to take on bushwalks and on the road.

300-03696

WHISKY CUP 285ML

300-03698

HIGHBALL CUP 425ML

300-03700

WINE GLASS 260ML

300-03702

FLUTE GLASS 190ML



PALM TRITAN FRIDGE JUG

The Palm Tritan Fridge Jug has many great features making it perfect for your RV, caravan and camping.

- > Drip-free spout the innovative v-shaped spout makes pouring a breeze as well as keeping ice cubes from falling into your glass.
- > The ergonomic handle is easy to hold with its large vertical grip section
- > The lid slides on easily yet locks when tipped.
- > Designed to fit standard fridge doors, the jug is not too high or wide.
- > Innovative design and production means there are no unsightly seam lines.

300-03704**FRIDGE JUG WITH CLEAR LID 1.3L****300-03706****FRIDGE JUG WITH WHITE LID 1.3L****300-03710****FRIDGE JUG WITH BLUE LID 1.3L****PALM TRITAN SALAD BOWL**

The Palm Tritan Salad Bowl with lid is a truly versatile item for your pantry. Unbreakable and dishwasher safe, this virtually airtight bowl can be used in many different ways, saving you precious storage space in your caravan or RV.

- > Salad bowl with lid keeps freshness in.
- > The lid on its own can be used as a serving tray.
- > The bowl can be used for all of your favorites such as chips, salad or fruit.
- > Flip the bowl over and it can be used with the lid as a base creating a covered cake tray.
- > Once inverted the bowl can be used to cover serving plates for freshness and hygiene.

300-03712**SALAD BOWL WITH CLEAR LID 26.5CM****300-03718****SALAD BOWL WITH BLUE LID 26.5CM****TOW BALLS & ACCESSORIES****350-00018****ARK TOW BALL MOUNT & TOW BALL**

The adjustable Ark Tow Ball Mount is designed to level your trailer and vehicle. It has five adjustable points and is suitable for 4x4s.

Max Towing Capacity: 2500kg*



* The towing capacity of the Ark Tow Ball Mount may exceed the towing capacity of the tow bar or vehicle. Always refer to the manufacturers specifications regarding the towing capacity of your tow bar or vehicle.

350-00021**ARK BLACK SHIN PROTECTOR WITH TOW BALL COVER**

Ensures that the tow ball cover is secured whilst towing, suitable for 50mm and 1 7/8" tow balls.

**350-00022****3.5 TON, 50MM CHROME PLATED TOW BALL**

Shank Size: 22.23mm

Diameter x 51mm, Towing Capacity 3500kg

**350-00024****3.5 TON, 50MM CHROME PLATED TOW BALL**

Shank Size: 22.23mm

Diameter x 62mm, Towing Capacity 3500kg

**350-00026****2.5 TON, 50MM CHROME PLATED TOW BALL**

Shank Size: 22.23mm

Diameter x 80mm, Towing Capacity 2500kg

**350-00028****2.0 TON, 25.4MM HI RISE 50MM CHROME PLATED TOW BALL**

Shank Size: 22.23mm

Diameter x 51mm, Towing Capacity 2000kg



REESE TOW VEHICLE ACCESSORIES

350-00040 RATCHETING CARGO BAR

Strong and easy to use, the Reese® Ratcheting Cargo Bar will keep your cargo secured in the ute tub, tray or boot. Fitted with rubber end pads it will also protect the vehicle from scratches and metal contact.

The Ratcheting Cargo Bar extends from 102cm to 178cm, fitting most tub and cab chassis utes even fitting SUV or family wagon boots to keep the shopping and luggage where you need it most.

- > Helps prevent cargo from moving during travel
- > Universal fit extends from 102cm to 178cm
- > Padded ratcheting handle making comfortable tightening a breeze
- > Easy ratchet function to tighten means that installation is quick and easy
- > Rubber ends ensure that the vehicle is protected from scratches and cargo slippage



350-00042 SMALL TAILGATE PROTECTIVE PAD

- > Simple installation and removal
- > Secures to tailgate with two attached straps with buckles
- > Top buckle strap secures cargo down to tailgate during transit
- > 600D weather resistant heavy duty fabric with a heavy duty foam core
- > Pad measurement 45cm x 22cm



350-00044 LARGE TAILGATE PAD

- > Universal - fits most medium and larger size tailgates
- > Pad measurement 135cm x 70cm
- > Added cushioning and protection
- > Rainproof tarpaulin material
- > Three straps wrap around tailgate and secure with three buckles
- > Additional hook and loop straps secure cargo to the pad
- > Flap in centre of pad allows tailgate handle access
- > 600D weather resistant heavy duty fabric with a heavy duty foam core



350-00046 TARP CLIPS 4 PC JAR

Need to anchor your tarp, awning or tent but don't have any usable eyelets?

Reese® Tarp Clips are the answer, made with high impact resistant plastic; the Tarp Clips provide hook anchor points to replace torn eyelets or to add additional anchor points where needed.

They are ideal for securing canopies, tarps, awnings, tents, covers and much more.

The vice-like gripping power keeps your tarp in place to keep your gear safe and secure from the elements. Sold in a handy-to-store container, the Tarp Clips are ready when you are.

- > Made of high impact resistant material that will not damage tarps or canopies
- > Ideal for securing tarps, canopies, awnings, tents, covers and much more
- > Heavy Duty and crack resistant
- > Vice-like gripping power
- > Easy to tighten, easy to release
- > Comes in a handy reusable container for storage; you'll never have to hunt around for them in your toolbox or bag again



350-00048 HITCH PIN LOCK & 3.6M CABLE

Prevent theft and lock your equipment, perfect for ute trays, trailers, caravans, roof and bike racks. Lock your cargo with ease

- > Installs in seconds with a push to lock feature
- > Stays on while towing
- > Braided steel for strength and flexibility
- > 3.6m vinyl coated 10mm cable
- > Corrosion resistant



350-00050 CHROME CLIP-ON TOW BALL COVER

Protect your clothing from grease, clips on securely thanks to the spring clip inside, suits 50mm & 47.63mm (1 7/8") tow balls.



350-00052 BLACK SOFT PVC TOW BALL COVER

Protect your clothing from grease, fits securely thanks to the moulded shape, suits 50mm & 47.63mm (1 7/8") tow balls.



350-00054 BLACK CLIP-ON TOW BALL COVER

Fits securely thanks to the spring inside, suits 50mm & 47.63mm (1 7/8") tow balls.



350-00056 TOW BALL BUDDY COVER & SHIN PROTECTOR

Enhance the look of your tow bar and keep your shins out of trouble with the ark tow ball buddy.

- > Clip on chrome cover
- > Covers ball and ball mount
- > Soft shin protector
- > Suits 50mm and 1 7/8" tow balls



350-00060 HAYMAN REESE HITCH STEP

Designed to stay in place whilst towing, the Hitch Step mounts over your tow ball. Three simple steps is all it takes to assemble your step onto the towbar's tow ball mount. The step features a high grade aluminium body with machine cut non-slip tread, making it corrosion resistant and giving extra grip for those slippery situations.



- > Easy to install, 4 bolts and you're done
- > Fits virtually any towbar, with a flat sided tow ball mount
- > Aluminium construction that is light-weight, corrosion resistant and looks great on the back of your car
- > High-grip non-slip step, keeping you safe in the wet
- > Raised upper lip to prevent you sliding off
- > Ideal for boat owners, helps keep your feet dry when launching or retrieving your boat

SPECIFICATIONS

Weight Capacity: 120kg
Length: 355mm
Width: 75mm

350-00070 BLACK SHIN PROTECTOR

No more bruised shins. Made from soft rubber the shin protector fits securely over the tow bar goose neck.

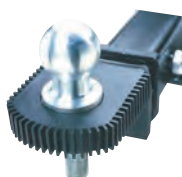

SHACKLES

The current standard applying to shackles is AS 2741-2002, however this standard does not specifically cover the use of rated shackles in an application such as attaching a trailer to a tow bar. This standard covers the use of shackles for lifting purposes.

The Caravan Industry Association of Australia's recommendation is that a shackle meeting the requirements of AS 2741-2002 be used to secure rated safety chains up to 3500kg capacity.

Suitable shackles have the following specifications:

- > Meet the requirements of AS 2741-2002
- > Shackle grade is "S" or "6"
- > Working load limit (WLL) is 1000kg
- > Shackle diameter is 10mm
- > Either "bow" or "dee" shackle design is suitable, although it is noted that the "bow" design provides greater angular displacement

A significant detail to understand is that the breaking load of a shackle is generally six times the working load limit." Source: RVMAP Technical Alert - D-Shackle Confusion Resolved, 20.10.2014

450-05000 DEE SHACKLE GALVANISED 8MM (5/16")

Not to be used with safety chains as this is a general purpose shackle.



450-05002 DEE SHACKLE GALVANISED 8MM (5/16")

Rated to 0.75t



450-05010 DEE SHACKLE GALVANISED 10MM (3/8")

With a working load rating of 320kg and a proof load rating of 640kg. Not to be used with safety chains as this is a general purpose shackle.



450-05012 DEE SHACKLE GALVANISED 10MM (3/8")

Rated to 1t



450-05020

DEE SHACKLE GALVANISED 12MM

A working load rating of 520Kg and a proof load rating of 1040Kg. Not to be used with safety chains as this is a general purpose shackle.



450-05022

DEE SHACKLE GALVANISED 11MM (7/16")

Rated to 1.5t



450-05024

DEE SHACKLE GALVANISED 13MM (1/2")

Rated to 2.0t



HAND BRAKE SPARES

450-05050

HAND BRAKE WIRE CABLE

4mm x 10m length



450-05060

HAND BRAKE CABLE ADJUSTER

(With Pulley)



450-05070

HAND BRAKE CABLE CLIPS



450-05080

BRAKE CABLE PULLEY



ALKO COUPLINGS

450-05110

2000KG 2-HOLE SNAP ON COUPLING WITH BALL ADJUSTER

Zinc plated surface, ball to first centre.



SPECIFICATIONS

Mounting Hole: 101.6L x 13.5W (mm)

Hole: 77mm

450-05120

3500KG ELECTRIC COUPLING WITH HAND BRAKE

A zinc plated coupling that is simple to attach to the tow ball.



SPECIFICATIONS

Mounting Hole: 182.5L x 55W (mm)

Diameter: 13.5mm

450-05130

2000KG MECHANICAL OVERRIDE COUPLING (NO PLATE)

A zinc plated coupling that is suited to 50mm ball types.



SPECIFICATIONS

Mounting Hole: 184L x 54W x 13.5 Diameter (mm)

Diameter: 137mm

450-05140

BRAKE PLATE FOR MECHANICAL OVERRIDE COUPLING

Has a painted surface.



SPECIFICATIONS

Mounting Hole: 184L x 54W x 13.5 Diameter (mm)

450-05146

ALKO AKS TOW BALL RETENTION PLATE

AKS anti-rotation 50mm tow ball plate for lug type tow bar 75mm wide.



450-05147**ALKO AKS HIGH RISE 50MM TOW BALL**

AKS anti-rotation 50mm high rise tow ball (black).

**450-05150****HYDRAULIC CONVERSION WITH 3/4" MASTER CYLINDER**

Converts mechanical couplings to hydraulic couplings (a more reliable braking system), suited for vehicles with a hydraulic drum/brake set up, zinc plated.

**MILENCO TOWING MIRRORS****350-00401****MILENCO AERO 4 GRAND - AUTOMOTIVE CONVEX GLASS - TOWING MIRROR (TWIN PACK)**

The mirror head design (Registered Design) utilises airflow around your car to stabilise and balance the mirror head at speed. This mirror has been extensively tested at speeds up to 250kph (155 mph), to ensure that you get the best vision possible. This design also offers superior performance in high winds and the effect of passing large commercial vehicles has been minimised.

**350-00402****MILENCO FALCON MIRRORS**

Lightweight and strap free, these Falcon mirrors feature an aerodynamic head to limit vibration whilst towing. They're super easy to attach to your vehicle's existing side mirrors, simply position the rubber grips onto your side mirror and tighten the thumb wheels accordingly. The convex mirror head is adjustable to maximise your tow vision. The Falcon comes with a handy storage bag and is suitable for use on most 4WD's and vans e.g. Nissan Navara. Sold in pairs.

**350-00403****MILENCO GRAND FALCON CONVEX TOWING MIRROR (TWIN PACK)**

The Grand Falcon Mirror offers a new design utilising a similar operation as the Milenco Grand Aero Mirror, but with using only a single thumb screw on each clamp for quick and easy fitting with a larger head, giving maximum field of view. Typically the larger field of view will show the roof, down to the wheels on the towed caravan/trailer.



Fitting is extremely simple with a single screw that clamps both the car mirror and the arm at the same time.

350-00405**MILENCO AERO 3 XXL WIDE CONVEX MIRROR (TWIN PACK)**

The Aero Extra Wide Mirrors and Grand Aero Extra Wide Mirrors are the same as the Aero 3 Mirrors and the Grand Aero 3 Mirrors. This mirror has longer arms for wider caravans, RV's or travel trailers, the Extra Wide Mirrors are only available in convex.



This enables users to have a better field of vision, particularly in instances when they have a narrow car and a wide caravan.

SPECIFICATIONS

Mirror Head: 220W x 140H (mm)

Arm: 420mm

350-00407
MILENCO GRAND AERO 3 EXTRA WIDE CONVEX TOWING MIRROR (TWIN PACK)

The Aero Extra Wide Mirrors and Grand Aero Extra Wide Mirrors are the same as the Aero 3 Mirrors. These mirrors have longer arms for wider caravans, RV's or travel trailers, the Extra Wide Mirrors are only available in convex.



The arm is approximately 41cm, as opposed to the Aero standard arm of 31cm.

This enables you to have a better field of view particularly when you have a narrow car and a wide caravan.

350-00409
MILENCO GRAND AERO PLATINUM TOW MIRRORS - TWIN PACK

The Aero Platinum Mirror is an innovative new design, specifically developed to securely fit to the extremely tapered mirror bezels, now found on increasing numbers of manufacturers vehicles to improve fuel efficiency by reducing aerodynamic drag.



350-00413
MILENCO MGI SAFETY TOWING MIRROR CONVEX SINGLES

This mirror is ideal for those who tow occasionally. The MGI - Milenco Safety Mirrors are simple to fit, but more importantly, they meet all the latest Safety Regulations for Towing Mirrors. The tensioning straps and handles means they can be adjusted to fit most typical traditional car mirrors. Sold in singles



MILENCO TOWING MIRRORS SPARES

350-00411
MILENCO REPLACEMENT AERO PADS (2 PER PACK)



350-00412
MILENCO AERO MIRROR HEADS CONVEX



350-00414
MILENCO AERO EXTRA WIDE ARMS PAIRS

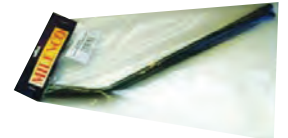

350-00415
MILENCO AERO GRAND MIRROR HEADS FLAT



350-00416
MILENCO AERO GRAND MIRROR HEADS CONVEX



350-00419
MILENCO AERO CLAMPS



REICH TOWING MIRRORS



Reich made quite a name for themselves when they developed the Move Control Series of caravan movers. Now these innovative Germans have produced a range of towing mirrors designed to give you a vibration free, hassle free & obstruction free towing experience. They feature a turn knob which controls the length of the straps, ensuring maximum tightening security onto the existing car mirror.

350-00600**REICH EXCELLENT VIEW TOWING MIRROR**

The pioneer in the Reich Mirror Series, adjustable clip on mirror suitable for vans, 4x4's, motor homes etc, rigid construction minimizing vibration, has rubber suckers to protect your cars mirror, has a large 20 x 13(cm) convex mirror. Sold singularly.

**350-00620****REICH HANDY MIRROR XL EXTENDED**

Same features as the XL mirror above but has longer arms making it suitable to tow wider & longer caravans. Sold singularly.

**350-00610****REICH HANDY MIRROR XL**

Features positive adjustable straps with quick release, has an adjustable mirror head, the jointed arms allow for installation on large size vehicle mirrors, has a large 20 x 13cm convex mirror. Sold singularly.

**350-00640****REICH SPEEDFIX MIRROR**

The name says it all! The Speedfix is a clip-on mirror with a patented rod end. The innovative fastening system, in conjunction with a semi-flex arm, ensures suitability with most 4WD and car mirrors. The rigid design and aerodynamic head ensures a vibration-free towing experience. Comes with a carry bag and is sold in pairs.

**SPECIFICATIONS**

Mirror Head: 220W x 120H (mm)

Arm: 350mm

350-01218 HAYMAN REESE COMPACT IQ PROPORTIONAL BRAKE CONTROLLER

The Compact IQ is the 'proportional' version of the 'time-activated' Compact brake controller (part number 350-01216 above). The Compact IQ encompasses minimalism, thanks to its super easy plug and play installation. Two dials are left on the dashboard facilitating easy operation, while the actual controller is installed behind or under the dashboard. Suitable for use with 1-3 axles, it includes a 'boost' function to give the driver the ability to set a minimum braking power. An LED indicator (one of the dials on the dashboard) constantly shows the status of the braking system. The Compact IQ is fully compatible with Electronic Stability Control systems and comes with a Hayman Reese 3yr warranty.



350-01238 TEKONSHA PRODIGY P2 12V BRAKE CONTROL

Suitable for 1 - 4 axle trailers, the Prodigy P2 is a proportional style brake controller. It is designed to work in with electronic-over-hydraulic brake systems and has numerous mounting options, incorporating 360 degree vertical rotation. The Prodigy P2 adjusts itself to the terrain as you drive, making it especially handy when reversing into tough spots. It works proportionally in reverse, with the ability to disable itself when it is not needed. The "boost" feature gives users the ability to apply more braking power when towing heavier trailers/ horse floats, which also gives you more control. When not being used, the Prodigy P2 can be easily disconnected allowing for storage elsewhere.



SPECIFICATIONS

Weight: 590g
Dimensions: 76H x 114W x 267L (mm)

350-01232 TEKONSHA #9030 VOYAGER 12V BRAKE CONTROL

The Voyager has recessed controls which protect the gain and level settings from accidental readjustment. Its internal sensor measures the amount of deceleration and sends the required amount of power to the trailer brakes. Its circuitry ensures minimum interference with other electronic systems such as ABS & cruise control. The Voyager has the traditional 4-wire hook up and comes with a U-shaped bracket for permanent installation. The LED display shows a complete circuit when green and as power (whether manual or automatic) is applied, it will change colour. Suitable for single and double axle trailers.



350-01250 TEKONSHA BREAKAWAY SWITCH (2010)

For trailers over 2000kg (Gross Trailer Mass) it is a requirement that a mechanism is in place in the event that if the trailer and tow vehicle separate accidentally, the trailer brakes are applied at full power for at least 15 minutes. One way to combat this is with a breakaway switch which sets the trailer brakes in case the trailer breaks away, however this is not to be used as a parking brake. Made from nylon with a weldable tab.



350-01260 TEKONSHA SHUR-SET III BREAKAWAY KIT

Kit includes a 5A battery with lockable case and nylon breakaway switch and only weighs 2.5kg.



SPECIFICATIONS

Dimensions: 15.9L x 16.2W x 21.6H (cm)

350-01274**BREAKSAFE REMOTE BATTERY MONITOR**

To be used in conjunction with the Breaksafe 6000 (part #350-01280 below), this remote monitor is fitted to the tow vehicle and checks the charge condition of the Breaksafe battery each time the brakes are applied. If the battery is low, a red light will be visible on the front panel of the monitor and a buzzer will sound.

**SPECIFICATIONS**

Dimensions (mm): 63W x 22H x 49L

350-01276**BREAKSAFE BATTERY**

A maintenance free and rechargeable sealed lead acid (SLA) battery. 12V, 7AH.

**350-01280****BREAKSAFE BREAKAWAY SYSTEM 6000**

The Breaksafe 6000 is suitable for use in caravans, trailers & horse floats. It is compact & easy to install &, has easy access to the battery compartment for servicing. Its lead acid battery as well as the internal circuit board case is enclosed offering better resistance to water. Suits all electric brakes & is charged using your vehicle's battery.

**BREAKSAFE ACCESSORIES****350-01283****BREAKAWAY SWITCH WITH COIL CABLE**

The Breaksafe Breakaway Switch now comes with a new coil cable and stainless steel quick release clip for easy connection to your towing vehicle. This also makes the connection to the tow vehicle much neater. The coil cable stretches to 1.2mts for connection to the tow vehicle and will compress to 100mm when disconnected.

**350-01285****BREAKAWAY COIL CABLE WITH PIN AND RELEASE CLIP**

Suitable for Breaksafe Breakaway switches only, this option is available if you already have a Breaksafe Breakaway Switch.

**TEKONSHA PRODIGY SPARE PARTS****350-01300****TEKONSHA PRODIGY MOUNTING BRACKET****350-01310****TEKONSHA PRODIGY POCKET MOUNT KIT****350-01320****TEKONSHA PRODIGY HARNESS KIT**

TOW SECURE BREAKAWAY KITS

350-01406 TOW SECURE TS2000 BREAKAWAY CONTROL + HARNESS WITH TEKONSHA SWITCH



The Tow Secure TS2000 automatically applies the trailer brakes and the trailer stop lights in the event that the trailer separates from the tow vehicle. The TS2000 uses the battery in your RV as its source of energy storage meaning that without an internal battery it is nice and compact. It features a 5m wiring harness to connect to the RV's battery which it will not draw power from while on standby

It has a wireless receiver which is housed on the dash so that the driver can monitor the battery status via LED and audible alarms. The control module performs a 'self-test' every time the tow vehicles' engine is started to ensure everything is operable and whilst towing. The control module can be paired with multiple wireless receivers - this may be required if the same trailer is towed by different vehicles.

- > Reduced size thanks to no internal battery
- > No power draw while on standby
- > 5m Wiring Harness
- > Power indicating LED

350-01500 TOW SECURE CHARGER

Input: 100/240VAC ~ 50/60Hz
Output: 15VDC ~ 1A Max.



350-01502 TOW SECURE RECEIVER ONLY



CURT BRAKE CONTROLLER'S

350-01340 CURT TRIFLEX™ BRAKE CONTROLLER

The TriFlex™ proportion-based brake controller features a compact size, a digital display and the ability to manage up to eight brakes at a time.



- > Triple-axis, motion-sensing accelerometer for highly responsive, smooth stops
- > Third axis provides dynamic power adjustments when going up or down a hill
- > Nine levels of sensitivity adjustment for varying loads or driving conditions
- > User-selectable power output and trailer brake light activation
- > Automatic levelling and calibration eliminate setup requirements
- > The digital display shows power adjustments in 0.1 increments
- > Built-in reverse-polarity and short-circuit protection
- > Tow vehicle 'low voltage' and trailer disconnect indicators
- > Compatible with low-volt, PWM, ABS, cruise control and electric over hydraulic
- > Mounts at various angles, above or below the dash, to increase usability
- > Auto sleep mode prevents battery drain after five minutes of idle time
- > Equipped with a quick plug for fast, easy installation
- > Includes mounting hardware

350-01342 CURT SPECTRUM BRAKE CONTROLLER - DASH MOUNT

Powerful, precise braking operation in an extremely simple and subtle design, dash-mounted inside your vehicle.



- > Controls all brake settings with a simple push-button rotary knob
- > Clean, dash-mounted, OEM-style user interface with 10 tri-colour LEDs
- > The main module can be mounted out of sight
- > Motion-sensing accelerometer for highly responsive, smooth stops
- > Easily accessible manual override with the press of a button
- > Features two installation options: drill mount or surface adhesive mount
- > User-selectable power output and trailer brake light activation
- > Automatic levelling and calibration eliminate setup requirements
- > Equipped with a quick plug for easy, plug-and-play installation
- > Operates 2-8 trailer brakes at a time (1-4 axles)
- > Built-in reverse-polarity and short-circuit protection
- > Compatible with low-volt, PWM, ABS, cruise control and electric over hydraulic
- > Tow vehicle 'low voltage' and trailer disconnect indicators
- > Includes mounting hardware
- > Knob outside diameter is 48mm

350-05232**SECURELATCH™ PINTLE HOOK**

The CURT SecureLatch pintle hook is fast and easy to adjust, featuring an auto-locking system and rated to 13,500kg. For use with the Rebellion™ XD Pintle Mount Attachment.



- > Auto-locking system secures primary latch without manual coupling required
- > Cupped hook tightly holds pintle ring fore and aft to reduce chocking and noise
- > Built-in backplate helps position pintle ring for easier hookup
- > Fits SecureLatch pintle mounts with a slotted plate (sold separately)
- > Quick, easy, one-tool height adjustments - no disassembly required
- > Integrated, intermediate safety chain hangers keep chains off the ground
- > Rated for 13,500kg gross trailer weight and 2720kg vertical load
- > Couples to pintle rings with a 2-1/2" or 3" inside diameter
- > Cast iron construction is austempered for superior strength and wear resistance
- > Battleship grey finish for excellent exterior durability
- > Bright zinc-plated hardware for corrosion resistance (mount bolts not included)
- > Limited lifetime warranty (one-year finish, one-year parts)
- > SecureLatch pintle mount and bolts required for installation (sold separately)
- > Safety pin must be installed before towing

350-50000**CURT REBELLION™ XD BALL MOUNT**

Dynamic, adaptive suspension ball mount featuring ShockDrop™ technology.



- > Dynamic, adaptive suspension ball mount featuring ShockDrop technology
- > Dampens jerking and jarring from bumps and potholes for smoother towing
- > Cushioned isolator reduces rattling and vibration for a more comfortable ride
- > Increases driver control by reducing the tendency for trailer sway
- > Improved trailer control during events of sudden braking
- > Virtually maintenance-free with no airbag or bearings to service
- > Minimises stress on tow vehicle's suspension and brakes for extended longevity
- > Lighter-weight design for less stress on the trailer hitch receiver
- > Adjustable, six-position head for precise levelling with different trailers
- > 152mm maximum drop (shank cannot be flipped)
- > Cast steel construction for dependable towing power
- > Textured, dark grey teridium finish for a premium look on your vehicle
- > Tested and rated to 4500kg/450kg
- > Fits 50mm Square Hitch (Class 4)

350-50002**REBELLION™ XD TONGUE ATTACHMENT (50MM TOW BALL)**

7/8" hole to accept a 50mm tow ball. Mounts onto CURT Rebellion™ XD Adjustable Ball Mount.



- > Mounts onto CURT Rebellion XD Adjustable Ball Mount
- > 7/8" hole to accept a 50mm tow ball
- > Constructed from cast steel for optimum strength
- > Protected by a dark grey teridium powder coat finish
- > Weight capacity: 3500kg/350kg

350-50004**REBELLION™ XD TONGUE ATTACHMENT (70MM TOW BALL)**

1-1/4" hole to accept a 70mm tow ball. Mounts onto CURT Rebellion™ XD Adjustable Ball Mount.



- > Mounts onto CURT Rebellion XD Adjustable Shank
- > 1-1/4" hole to accept a 70mm tow ball
- > Constructed from cast steel for optimum strength
- > Protected by a dark grey teridium powder coat finish
- > Weight capacity: 4500kg/450kg

350-50006**REBELLION™ XD PINTLE MOUNT ATTACHMENT**

Accepts any CURT mount-style pintle hook or ball and pintle combination hitch. Mounts onto CURT Rebellion™ XD Adjustable Ball Mount.



- > Mounts onto CURT Rebellion XD Adjustable Shank
- > Accepts any CURT mount-style pintle hook or ball and pintle combination hitch
- > Integrated rubber dampener for enhanced vibration resistance
- > Constructed from cast steel for optimum strength
- > Protected by a dark grey teridium powder coat finish
- > Standard pintle plate holes spaced 84mm wide by 31mm high
- > Weight capacity limited to Rebellion XD ball mount
- > Includes four bolts to mount the pintle hitch (Rebellion XD sold separately)

350-50010**REBELLION™ XD TONGUE & HITCH LOCK SET**

This lock set for the Rebellion™ XD ball mount provides enhanced security for your towing setup. The unique, integrated design fits all CURT Rebellion XD accessories.



- > Lock set secures both Rebellion XD tongue and shank
- > Locks replace standard clips and hitch pin for increased security
- > The unique, integrated design fits all CURT Rebellion XD accessories
- > Easy-to-operate, 1/4-turn lock activation
- > Locks keyed alike for convenient one-key operation
- > Cast aluminium accessory lock for superior weather resistance
- > Stainless steel hitch lock for lasting rust resistance
- > Includes two locks and two keys

350-51000**CURT 5/8" TOW HITCH PIN WITH CLIP SET**

- > 15.8mm diameter pin fits 50 Square Hitch (Class 4)
- > Secures ball mounts and other receiver tube inserts
- > Bent handle for an easier grip



350-51002 CURT 5/8" GROOVED TOW HITCH PIN WITH CLIP SET

- > 15.8mm diameter pin fits 50mm Square Hitch (Class 4)
- > Secures ball mounts and other receiver tube inserts
- > Grooved pin allows clip attachment at any angle
- > Protected by a durable zinc-plated finish



350-51010 CURT 5/8 IN RIGHT ANGLE LOCKING TOW HITCH PIN

- > 15.8mm diameter pin fits 50mm Square Hitch (Class 4)
- > Right-angle design with swivel head for easier access
- > Protected by a durable chrome-plated finish
- > Easy-to-operate, 1/4-turn lock activation
- > Watertight dust cap prevents internal corrosion
- > Includes two keys for added convenience



350-51012 CURT 5/8 IN DOGBONE LOCKING SS TOW HITCH PIN

- > 5.8mm diameter pin fits 50mm Square Hitch (Class 4)
- > Stainless steel construction for lasting rust resistance
- > Easy-to-operate, 1/4-turn lock activation
- > Watertight dust cap prevents internal corrosion
- > Includes two keys for added convenience



350-51014 CURT 5/8 IN DOGBONE CHROME LOCKING TOW HITCH PIN

- > 15.8mm diameter pin fits 50mm Square Hitch (Class 4)
- > Protected by a durable chrome-plated finish
- > Easy-to-operate, 1/4-turn lock activation
- > Watertight dust cap prevents internal corrosion
- > Includes two keys for added convenience



350-52000 CURT TRUTRACK™ WEIGHT DISTRIBUTION HITCH WITH SWAY CONTROL

TruTrack™ weight distribution hitches with sway control are one of the most advanced weight distribution hitches on the market.



- > Integrated sway control actively resists sway and levels the vehicle and trailer
- > Welded head with cast pieces provides solid spring bar attachment
- > Uses spring & cam system with hardened components, instead of metal friction
- > Adjustable brackets provide fixed support unlike spring bar chain models
- > Brackets use friction to resist lateral movement, replacing a sway control

350-53000 ROCKERBALL™ 50MM CUSHION HITCH TRAILER BALL

As your trailer passes over bumps and potholes, it produces all kinds of vibrations, jolting, chucking and noise. With a traditional metal-on-metal connection, these annoyances are directly transferred to your tow vehicle, making your ride noisy, uncomfortable and taking a toll on your towing system.



The CURT RockerBall™ trailer ball provides improved comfort and enhanced control while towing, featuring our unique ShockDrop™ technology. An integrated cushion isolator allows this hitch ball to turn a standard ball mount into a cushion hitch with anti-rattle capabilities.

- > Dynamic trailer ball featuring ShockDrop technology
- > Dampens jerking and jarring from bumps and potholes for smoother towing
- > Cushioned isolators reduce rattling and vibration for a more comfortable ride
- > Reduces shock loads to the vehicle during sudden braking or acceleration
- > Minimizes stress on tow vehicle's suspension and brakes for extended longevity
- > Retrofits onto most existing ball mounts to improve current towing experience

350-52500 CURT SWAY CONTROL KIT

CURT Sway Control Kit is adjustable and easy to install. It comes with a sway unit, a trailer-mounted attachment ball, and bolts, a hitch-mounted attachment ball, a weld-on tab, a mount reinforcement plate, and attachment clips.



Though a weight-distribution hitch is not an ideal solution for trailer sway on its own, CURT weight distribution hitches are made to be combined with a sway control unit and many are available with sway controls included for a complete package.

- > Features adjustment bolt to accommodate different load sizes
- > On/Off handle makes it easy to engage or disengage sway control as needed
- > Two sway control units are recommended for larger trailers
- > Compatible with most A-frame trailers (bolt-on bracket included)
- > Includes sway control unit, trailer-mounted attachment ball & bolt, hitch-mounted attachment ball, weld-on tab to adapt for left-hand use or for use without weight distribution hitch, mount reinforcement plate and attachment clips.

350-00030**CURT TRAILER BALLS**

CURT Trailer Balls are designed for strength, ease of use, and ultimately, to get you to your destination without hassle.

These tow balls are an excellent extension of your class 3 or class 4 trailer hitch and ball mount, and are the ideal choice for most pickup trucks and SUVs (NOTE: Never exceed the lowest weight capacity of any towing component; i.e. the vehicle, hitch, trailer, etc).



To give you peace of mind while towing to that next destination, we also carefully test our trailer balls and ensure that each one meets U.S. VESC specifications.

- > Fine threads for superior hold
- > Chrome-plated finish
- > Zinc-plated hardware
- > VESC tested for safety

450-00500**CURT WHEEL CHOCK SET (UP TO 17" WIDE WHEELS)**

- > Ideal for chocking wheels on parked trailer
- > Perfect for adding safety during vehicle maintenance
- > Compatible with wheels up to 17" wide
- > Raised tread offers a better grip on the wheel
- > Saw-tooth edges on the base provide solid traction on the ground
- > Constructed from durable plastic
- > Always to be used with vehicle brake
- > Not for commercial use

**CURT CARGO BAGS**

CURT cargo bags are the ideal way to keep your belongings well protected from water, dirt, road grime and even wind damage, all while being easy to manage and perfectly fitted for a CURT cargo carrier or roof basket. Unlike other cargo bags that use a thin vinyl material, our cargo bags are made from a thick UV-resistant vinyl and have welded seams to be highly water-resistant. Thick, 1" wide polypropylene straps keep the bag firmly attached to the carrier and ensure your belongings will not jostle around.

400-04400**CURT CARGO BAG WEATHER-RESISTANT VINYL**

1422 x 457 x 533mm

**400-04402****CURT CARGO BAG WEATHER-RESISTANT VINYL**

1422 x 558 x 533mm

**400-04404****CURT CARGO BAG WEATHER-RESISTANT VINYL**

965 x 863 x 457mm

**400-04406****CURT CARGO BAG WEATHER-RESISTANT VINYL**

1498 x 863 x 533mm



LIPPERT TIRE LINC

**ALWAYS BE READY FOR THE ROAD.**

Is your RV ready for the road? The Tire Linc® (TPMS) by Lippert™ is the easy-to-install, always-on tyre pressure and temperature monitoring system that makes sure you're always ready for the road. Integrated with Lippert's OneControl® app, you can monitor your camper trailer, caravan, motorhome, or towed vehicle's tyre pressure and temperature right from your smartphone – don't mess with additional dashboard interfaces again.

350-01624**LCI LIPPERT TIRE LINC 2.0 AU BLUETOOTH TPMS KIT**

Tire Linc® comes complete with four sensors that easily screw on to your existing tyre valves. Additional sets of two extra sensors are sold separately. Installation is a breeze. Starting in 2021, certain RV models will be prepped for the Tire Linc system. For these models, simply place the repeater in the preinstalled docking station and you're ready to go. For those campers not prepped for Tire Linc, the repeater dock (sold separately) will need to be wired into the RV's 12V power system. The Tire Linc® repeater boosts your tyre's sensor signals to ensure that wherever you are, your system is communicating tyre pressure and temperature effectively.



Before a trip, on the road, and in any weather conditions, make sure you know the state of your tyres, with the monitoring system from a manufacturer you trust.

SPECIFICATIONS

- › **CONSTANT PRESSURE/TEMPERATURE MONITORING** – Sensors update pressure and temperature several times each minute while your RV is moving and check every 15 minutes while parked. Plus, sensors notify you any time the tires inflate, deflate, or in the case of a blowout
- › **REPEATER TECH BOOSTS SIGNAL** – Repeater technology "repeats" the signal your sensors send, but stronger, so that your smartphone always has the most up-to-date information.
- › **INTEGRATION WITH ONECONTROL APP** – Manage your sensors, set tyre pressure ranges, get notifications, and view alerts all from your smartphone with the OneControl® app from Lippert™
- › **MONITOR MORE TIRES** – Tire Linc® Tire Sensors allow you to monitor up to 20 tyres at a time with your Tire Linc system. Our additional sensor packs (sold separately) are a perfect way to monitor all tyres on larger RVs, motorhomes, and even tow vehicles
- › **SIMPLE INSTALLATION** – Sensors easily screw on to existing tyre valves, and the repeater plugs into a pre-installed dock (on specific 2021 and beyond models only). Use your OneControl® app to configure sensors and set acceptable tyre pressure ranges

LIPPERT LCI SWAY COMMAND KIT



Tow with confidence. Tow with peace of mind. If you tow a travel trailer RV you know all too well how scary a sway event can be, especially when making emergency maneuvers at high speeds or in heavy crosswinds.

Lippert's new patent pending Sway Command Tow Control Technology is here to take away those fears and promote safety by applying the brakes before a sway event can get out of control!

The Sway Command utilizes both an accelerometer (measures lateral force) and gyroscope (measures angular velocity) to quickly and accurately differentiate between side-to-side and up-and-down movement to prevent false activation - very useful, especially off road!

It has an advanced, patent pending, microprocessor technology that electronically detects trailer sway to apply the brakes swiftly to suppress unwayed sway. A light pod mounts to the front of the trailer to signal to the driver when the system is functioning properly.

The Sway Command has been rigorously tested in sway-inducing towing conditions, including emergency maneuvers, so you can be confident in its abilities. Plus, the controller works independently from your existing brake control so if there is a short or disconnect in the tow vehicle connection, the Sway Command won't also be affected.

350-01710 LCI SWAY COMMAND 1.5 AUS KIT



350-01720 ROAD GUARD PREFABRICATED CHASSIS BRACKET T/S SWAY COMMAND



QUICK FIT BIKE RACKS



Coast's new Quick Fit Bike Racks are designed to make it easier than ever to take bikes with you on your next adventure. They feature a patented quick connector that makes it extremely quick and easy to fit the racks onto your tow ball!

Unlike other bulky bike racks, the Quick Fit range is made with an ingenious folding system unique to the XF series. This allows you to collapse the Bike Racks to a convenient size that make them easy to carry and store. They even have a clever tilt mechanism that gives you clear access to your boot while the Quick Fit Racks are installed.

The Quick Fit XF series are designed to suit all 50mm tow balls thanks to the adjustable quick connector and can carry nearly all bikes (including e-bikes) and wheel dimensions on their wide aluminium wheel holders. The Quick Fit Pro offers incredible value for money and allows you to mount your bikes so there is no force on the pedals and uses wide plastic wheel holders. The full range features optional Assist Ramps that allows users to maneuver bikes onto the rack effortlessly.

You won't need to worry about putting them together either - they come ready to go straight out of the box and come with everything you need including a handy storage bag.

350-20100 QUICK FIT XF3 FOLDING BIKE RACK - 60KG CAP

The Quick Fit XF3 is a safe and reliable bike carrier for the transportation of 3 bicycles.

- > Suitable for almost all tow bars, all bicycles (also e-bikes) and wheel dimensions
- > An ingenious folding system makes it easy to carry and store
- > Extremely easy and quick fitting onto the tow bar with the patented quick connector
- > Boot is always accessible thanks to the easy to use tilt mechanism
- > The bicycles are held in wide, stable aluminium wheel holders
- > Flexible lockable and removable Quick Fit frame holders
- > Storage bag included
- > Lighting via a 7 plug
- > Immediate usable from the carton



- > The bike carrier can be secured with the lock on quick connector
- > In combination with the ride-on ramp (350-20120) you can even more easily manoeuvre your bicycle onto the bike carrier

SPECIFICATIONS

Number of bicycles: 3
Tilttable: Yes
Foldable: Yes
 Mounting of bicycles by lockable and removable frame holders
Weight: approx. 21 kg
Maximum load: 60 kg
Bicycle frame diameter: Ø 22 - 75 mm*
Wheel base bicycle max.: 1250 mm
Bicycle tyre width max.: 55 mm
Wheel holder distance: approx. 220mm
Colour: Black
Material: Coated steel + aluminium

350-20102**QUICK FIT XF2 FOLDING BIKE RACK - 60KG CAP**

The Quick Fit XF2 is a safe and reliable bike carrier for the transportation of 2 bicycles.

- > Suitable for almost all tow bars, all bicycles (also e-bikes) and wheel dimensions
- > An ingenious folding system makes it easy to carry and store
- > Extremely easy and quick fitting onto the tow bar with the patented quick connector
- > Boot is always accessible thanks to the easy to use tilt mechanism
- > The bicycles are held in wide, stable aluminium wheel holders
- > Flexible lockable and removable Quick Fit frame holders
- > Storage bag included
- > Lighting via a 7 plug
- > Immediate usable from the carton.
- > The bike carrier can be secured with the lock on quick connector
- > In combination with the ride-on ramp (350-20120) you can even more easily manoeuvre your bicycle onto the bike carrier

**SPECIFICATIONS**

Number of bicycles: 2

Tiltable: Yes

Foldable: Yes

Mounting of bicycles by lockable and removable frame holders

Weight: approx. 17 kg

Maximum load: 60 kg

Bicycle frame diameter: Ø 22 - 75 mm*

Wheel base bicycle max.: 1400 mm

Bicycle tyre width max.: 50 mm

Wheel holder distance: approx. 210mm

Colour: Black

Material: Coated steel + aluminium

350-20106**QUICK FIT PRO BIKE RACK - 60KG CAP**

The Quick Fit Pro is a safe and reliable bike carrier for the transportation of 2 bicycles.

- > Suitable for almost all tow bars, all bicycles (also e-bikes) and wheel dimensions
- > Extremely easy and quick fitting onto the tow bar with the patented quick connector
- > Boot stays always accessible by an easy to use tilt mechanism
- > The bicycles are held in wide, stable plastic wheel holders
- > Mounting the bicycles with the frame, so there is no force on the pedals of the bicycle
- > Flexible and lockable frame holders
- > Lighting via a 7 plug
- > The bike carrier can be locked with lock on quick connector
- > European permission given by the RDW



In combination with the ride-on ramp (350-20124) you can even more easily manoeuvre your bicycle onto the bike carrier

SPECIFICATIONS

Number of bicycles: 2

Tiltable: Yes

Foldable: No

Mounting of bicycles by lockable and removable frame holders

Weight: approx. 17 kg

Maximum load: 60 kg

Bicycle frame diameter: Ø 22 - 75 mm*

Wheel base bicycle max.: 1300 mm

Bicycle tyre width max.: 50 mm

Wheel holder distance: approx. 200mm

Colour: Silver

Material: Coated steel

* The maximum dimensions for any vehicle, including its load, are 2.5m in width and 4.3m in height. A vehicle fitted with a bicycle carrier, along with any bicycles must not exceed these limits. Rear-mounted bicycle carriers must also comply with rear overhang limits. Any rear overhang on a vehicle must not exceed 60% of the wheelbase or 3.7m, whichever is less.

QUICK FIT ASSIST RAMPS

A ramp makes effort unnecessary and bicycles can be easily manoeuvred onto the bike carrier. These ramps are suitable for Quick Fit bike carriers and are easy to fold up and store.



By placing a pin in the bike carrier's wheel holder, you can attach the ride-on ramp firmly and manoeuvre the bikes on and off easily.

350-20120**QUICK FIT XF BIKE ASSIST RAMP****350-20124****QUICK FIT PRO BIKE ASSIST RAMP**

CARRY BIKES

Flexible and sturdy with a renewed design, the best-selling Fiamma bike carriers boast a new shape and colour to blend perfectly with most modern RVs.

350-02008 FIAMMA CARRY BIKE XL A PRO 200 A FRAME MOUNT 2 BIKES

Equipped with the external rail in two pieces to grant maximum possibility of installation and use. Smaller size for short drawbars.



SPECIFICATIONS

Weight: 7.5kg
Max Load Weight: 50kg

350-02022 FIAMMA CARRY BIKE CARAVAN XL A BLACK 2 BIKES

Compact and inexpensive, fits almost all Caravan frames (including Al-Ko).



SPECIFICATIONS

Weight: 5.3kg
Max Load Weight: 35kg

350-02013 FIAMMA CARRY BIKE CARAVAN XL A PRO 200 E-BIKE

The installation does not require holes on standard.



A-frame

- > Installation brackets Supplied as standard. Bike carriers installation without drilling holes on standard A-frames.
- > Quick Lock Quick and safe locking of the wheel to the rail
- > Protective bumpers To protect the bike from impacts with the bike carrier structure
- > Bike-Block Pro / Pro S Bike locking system
- > Rails The model changes according to technical characteristics
- > Security block Locks the support rail during transport
- > Tensioning strap In the Active and Active E-Bike versions it makes access to the storage compartment easy and immediate

350-02017 FIAMMA CARRY BIKE VAN 200D

An easily installed bike carrier for vans with double rear doors (no need to drill the vehicle). The wheelbase is adaptable, from 58 - 62cm, to adapt to different sized doors. Carries up to two bicycles and is suited to vehicles such as: Fiat Ducato before 1999, Ford Transit and Ford Transit (high roof).

SPECIFICATIONS

Max Load Weight: 35kg

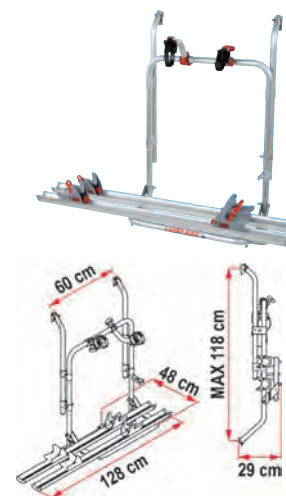

350-02020 FIAMMA CARRY BIKE BACKPACK 4x4

Best suited to minivans. The Backpack 4x4 is quickly installed onto the rear spare tyre by means of sturdy straps, however it will be necessary to remove the cover of the spare tyre. Has a folding rail support and can hold two bicycles. When installing, be sure not to cover the license plate or lights.

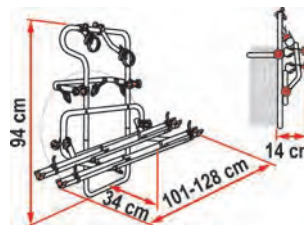

SPECIFICATIONS

Max Load Weight: 35kg

350-02041 FIAMMA CARRY BIKE PRO M, BLACK



350-02042

FIAMMA CARRY BIKE PRO WITH BLACK AESTHETICS

This telescopic bike carrier, the longer version of the pro series, has a highly adjustable upper structure for better stability and is height adjustable from 80cm to 150cm. Able to carry up to 4 bicycles.

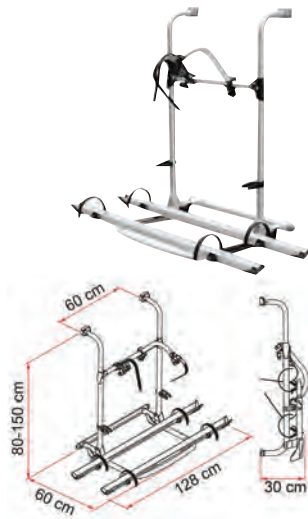

350-02044

FIAMMA CARRY BIKE PRO C WITH BLACK AESTHETICS

This compact and classic bike carrier is the short version of the pro series. It can be installed under the rear window while still allowing the window to open. The Pro C can be installed on most motorhomes and has been recommended as one of the strongest bike carriers on the market. Able to carry up to four bicycles.

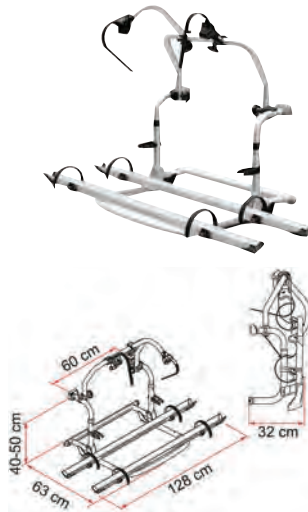

PRO SERIES E CARRY-BIKES

Two structurally sturdy models, equipped with fixed rail support base designed specifically for electric bikes, featuring the Bike Block Pro S and Rail Premium.

350-02047

FIAMMA CARRY BIKE PRO E-BIKE WITH BLACK AESTHETICS

The telescopic bike carrier, leader of Pro line, here is the special version for E-Bikes. Has a highly adjustable upper structure for better stability. The rounded tube structure is easily adjustable from 80 to 150cm in height to fit different installation requirements.

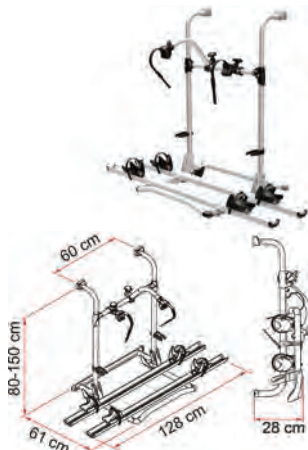

350-02049

FIAMMA CARRY BIKE PRO C E-BIKE W/ BLACK AESTHETICS

350-02063

FIAMMA CARRY BIKE VWT5

Another one of Fiamma's best sellers, the Carry Bike VWT5 is easily installed (no drilling required) on VWT5's built after July 2003. It is designed for T5's with a single rear door and has the capacity to fit up to four bicycles.



SPECIFICATIONS

Max Load Weight: 60kg

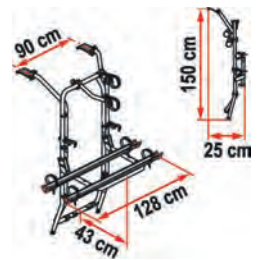

350-02033

FIAMMA CARAVAN ACTIVE E-BIKE

Special version specifically designed for the transportation of two electric bicycles. Thanks to the system with tensioning strap, access to the storage compartment is easy and quick.



350-02080

FIAMMA CARRY BIKE LIFT 77 BLACK

Standard version, lowering as much as 77cm and enabling the bikes to be loaded and unloaded easily.



350-02083

FIAMMA CARRY BIKE LIFT 77 E-BIKE

Special version for transporting two electric bikes. It has been further strengthened to carry up to 60 kg in complete safety and with maximum ease of loading.



350-02052 FIAMMA CARRY BIKE UL

The UL is suitable for installation on motorhomes without a rear window. It is able to carry two bikes as standard, to carry a third bike (with a max load of 55Kg) an extra Bike-Block and Rail will need to be purchased. The mounting bars can be adjusted from 80-150cm, making the UL the preferred choice of many motorhome manufacturers.

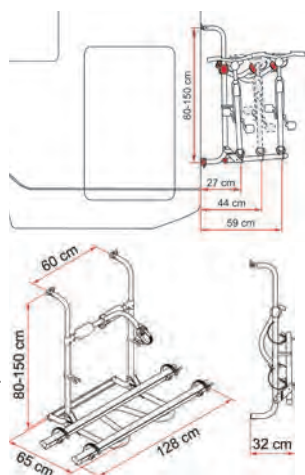

SPECIFICATIONS

Weights: 5.6kg

FIAMMA CARRY BIKE ACCESSORIES

350-02000 FIAMMA BIKE FRAME ADAPTER

Frame adapter for easy attachment to Bike-Block of bikes with non-standard frames without a cross bar such as ladies bikes and BMX's.



350-02210 E-BIKE REPLACEMENT RACK FOR PRO & PRO C

Now you can turn your Carry-Bike Pro / Pro C into a E-Bike bike carrier by purchasing the new Kit Upgrade E-Bike.

Complete rail support base with two Rail Premium, structurally designed to carry two electric bicycles.

Specifications

| Description | Pro E -Bike | Pro C E-Bike | XLA Pro 200 |
|------------------------|---------------------|---------------------|-------------|
| Part Number | 350-02046 | 350-02048 | 350-02013 |
| Vehicle Type | Motorhome & Caravan | Motorhome & Caravan | Caravan |
| Weight | 10.4kg | 9.9kg | 10kg |
| Max load | 60kg | 60kg | 50kg |
| Bikes Carried standard | 2 | 2 | 2 |
| Bikes carried max | 2 | 2 | 2 |

350-02252 FIAMMA CABLE LOCK FOR CARRY-BIKE (2.5M)

Comes with 2 keys.



350-02290 FIAMMA BIKE - RACK RAIL (128CM)

With Quick Strap.



350-02295 FIAMMA BIKE-RACK RAIL WITH BLACK END CAPS AND QUICK STRAP



350-02298 FIAMMA CARRY BIKE RAIL PREMIUM (128CM)



350-02215 FIAMMA RAIL PREMIUM XL (E-BIKE)

The XL version is longer (139cm) and suited for particularly long E-Bikes and Mountain-Bikes (with wheelbase > 125cm).

350-02320 FIAMMA BIKE BLOCK PRO - 1 RED FOR CARRY-BIKE (110MM)

SPECIFICATIONS

Weights: 0.2kg



350-02322 FIAMMA BIKE BLOCK PRO-2 RED FOR CARRY-BIKE (230MM)

SPECIFICATIONS

Weights: 0.3kg



350-02324
FIAMMA BIKE BLOCK
PRO-3 RED FOR
CARRY BIKE (375MM)

SPECIFICATIONS

Weighs: 0.4kg

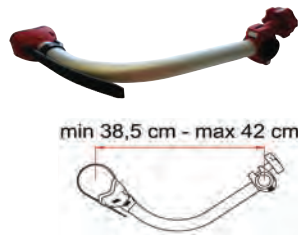

350-02326
FIAMMA BIKE BLOCK
PRO-4 RED
FOR CARRY BIKE
(530MM)

SPECIFICATIONS

Weighs: 0.5kg



350-02330
FIAMMA BIKE BLOCK
PRO D-1

SPECIFICATIONS

Weighs: 0.6kg

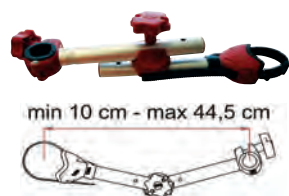

350-02332
FIAMMA BIKE BLOCK
PRO D-2

SPECIFICATIONS

Weighs: 0.7kg

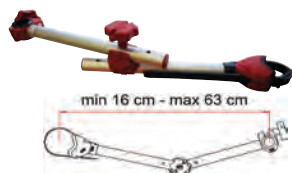

350-02350
FIAMMA CARRY BIKE RACK
HOLDER

A locking system for added security when not carrying any bikes.



350-02360
FIAMMA BIKE BLOCK PRO
1 BLACK



350-02362
FIAMMA BIKE BLOCK PRO
2 BLACK

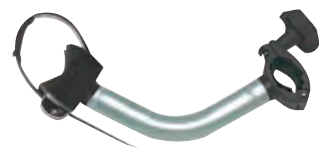

350-02364
FIAMMA BIKE BLOCK PRO
3 BLACK



350-02366
FIAMMA BIKE BLOCK PRO
4 BLACK



350-02501
FIAMMA BIKE COVER
PREMIUM S 2/4 BIKES

Same features as the Bike Cover S but with self-lubricating side zippers and velcro, forms a complete enclosure around the bikes. For a correct installation, you must place it before bicycles.



350-02503
FIAMMA BIKE COVER S 2
TO 3 BIKES
(SOLD EACH)

It adapts to any size load thanks to its adjustable straps. Delivered as standard with transparent pocket to insert the rear signal plate.



350-02521
FIAMMA BIKE COVER
EXTRA STRONG
"CARAVAN"

With K-Way system, special version to cover bikes on Carry-Bike CaravanXL A, XL A PRO / E-Bike and Active / E-Bike.



350-02530N FIAMMA CARRY BIKE COVER S

Made from lightweight and waterproof polyester, the Bike Cover S has the capacity to cover up to x4 bicycles, thanks to its adjustable straps (with hooks). It comes with a transparent pocket to insert a rear signal plate. Please note, the Bike Cover S is not suitable for bike racks where the bicycles are exposed over the top of the roof. Weighs: 1kg



350-05300 HAYMAN REESE 180LB MINI

The Mini WDS is the solution for towing lighter ball weights such as a trailer. It is a two bar system (19mm diameter) which uses chains to hold the spring bars into position and can be used with any Hayman Reese towbar. It is easily setup and removed and is best suited to trailers with a ball weight up to 80kg.



HAYMAN REESE WEIGHT DISTRIBUTION SYSTEMS

Hayman Reese have been Australia's number 1 towing brand for over 60 years and that is why they back their products with a Hayman Reese Lifetime Warranty. Weight Distribution Systems (WDS) restore the geometry of the tow vehicle (such as a ute) to its natural state. A WDS transfers the weight from the rear wheels of the ute to two places: the front wheels of the ute and the wheels of the trailer. To put it simply, a good WDS will level the link between trailer and ute so it is in parallel alignment to the road.

When towing a trailer, the trailer's total ball weight is applied to the rear of your vehicle. When this happens, the front suspension of your vehicle is raised because of the added rear weight. Towing in this way can cause excess swaying of your trailer, reduced steering and breaking responsiveness, less traction and headlights that beam upwards instead of down onto the road in front of you. Over time, you may also experience reduced fuel economy and increased tyre wear (especially on the rear tyres). Hayman Reese have a number of WDS's available to improve control over your vehicle while towing and reducing the amount of sway you experience.

Use the table below to find out which Hayman Reese WDS is best for you:

| Ball Weight: | RECOMMENDED WEIGHT DISTRIBUTION SYSTEM | | | | |
|---------------|--|--------------|--------|-------|-------------|
| | Mini | Intermediate | Medium | Heavy | Super Heavy |
| 0-80kg | ✓ | | | | |
| 80-135kg | | ✓ | | | |
| 135-275kg | | | ✓ | | |
| 275-365kg | | | | ✓ | |
| 365-545kg | | | | | ✓ |

350-05310 HAYMAN REESE 285LB INTERMEDIATE

The Intermediate WDS is the solution for towing intermediate ball weights such as a camper trailer. It is a four bar system (19mm diameter) which has a working range of between 80kg and 135kg ball weights. The snap up brackets make raising and lowering the chains effortless. There are also triangular plates which allow you to adjust and equalize each pair of bars together.



350-05320 HAYMAN REESE 600LB STANDARD MEDIUM 30" SPRING BARS

The most popular towing aid in Australia which is rated for trailers that have a ball weight of between 135kg and 275kg (suitable for most popular caravans). It has a durable and light cast steel head. Its round, hook style spring bars have integrated cams which are ideal for caravans with 6" deep A-frames. It also features a Hex Cam adjustment washer which allows for up to six head-angle adjustments.



350-05330 HAYMAN REESE 600LB CLASSIC MEDIUM 30" SPRING BARS

Similar to the 600lbs Standard WDS except that the Classic WDS is composed of the Hayman Reese traditional welded head. The Classic WDS has straight, trunnion style, high performance spring bars with integrated cams and an updated lightweight (but extra durable) cast steel shank. Suitable to towing most popular caravans, it has a ball weight capacity of between 135kg and 275kg.



350-05340
HAYMAN REESE 600LB
CLASSIC MEDIUM 28"
SPRING BARS

This WDS has all the same features and benefits as the 600lbs Classic Medium WDS above, except that it has slightly shorter spring bars. This is to accommodate caravans or horse floats with a shorter A-frame. It is also suitable for towing most popular caravans and also has a ball weight capacity of between 135kg and 275kg.



350-05380
HAYMAN REESE 1200LB
SUPER HEAVY DUTY

The Super Heavy WDS has a working ball weight range of between 365kg and 545kg. Please note however, that if you intend to carry a load in excess of 3,500kg, you will need a 70mm tow ball. Manufactured for serious heavy duty towing, it has a fine tooth adjustment washer which allows for up to nine head-angle adjustments. The drop shank allows for six height adjustments and because of the added weight, Hayman Reese have made it compatible with the Dual Cam HP Sway Control (this is available separately).



350-05350
HAYMAN REESE 800LB
STANDARD HEAVY DUTY
30" SPRING BARS

Suitable for towing larger and heavier trailers (such as twin axle caravans), the Standard Heavy Duty WDS relies on heavier gauge spring bars to handle the heavier load. This WDS has a ball weight capacity of between 275kg and 365kg and has 30" hook style spring bars with integrated cams. A Hex Cam adjustment washer allows for up to six head-angle adjustments, while the drop shank allows for up to six height adjustments.



DROP SHANKS AVAILABLE TO SUIT HAYMAN REESE WEIGHT DISTRIBUTION SYSTEMS

Hayman Reese have a range of Drop Shanks available to setup the system on 4WD's and other vehicles where the lowest/highest setting is not low/ high enough. Please seek advice from your Coast stockist to check which Drop Shanks are compatible with your vehicle.

350-05390
HAYMAN REESE
DROP SHANK
- STANDARD

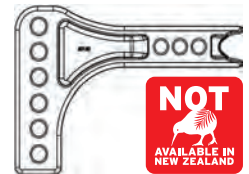

350-05360
HAYMAN REESE 800LBS
CLASSIC HEAVY DUTY 30"
SPRING BARS

Similar to the 800lbs Standard WDS except that it is composed of the Hayman Reese traditional welded head. The 800lbs Classic WDS has straight, trunnion style, high performance spring bars with integrated cams and an updated lightweight (but extra durable) cast steel shank. Suitable for towing larger twin axle caravans, it has a ball weight capacity of between 275kg and 365kg.



350-05400
HAYMAN REESE
DROP SHANK
- 30MM

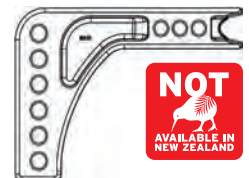

350-05410
HAYMAN REESE
DROP SHANK
- 95MM



350-05370
HAYMAN REESE 800LB
CLASSIC HEAVY DUTY 28"
SPRING BARS

This WDS has all the same features and benefits as the 800lbs Classic Heavy Duty WDS except that has slightly shorter spring bars. This is to accommodate caravans or horse floats with a shorter A-frame. It is also suitable for towing most larger twin axle caravans and also has a ball weight capacity of between 275kg and 365kg.



350-05420
HAYMAN REESE
DROP SHANK
- 160MM



EAZ LIFT WEIGHT DISTRIBUTION HITCHES



Over 50 years ago, Eaz Lift became the first patented weight distribution system in North America and is still the most popular WDH in the USA. Coast to Coast has recognised a product that has been tried and tested and now re-developed to suit Australian standards. It has been designed with fewer parts, making it easier to use and install. The Eaz Lift WDHs are constructed from high grade, machine tapered, round spring steel bars and are available in a 600 or 800 series. Both the 600 and 800 series include bolt-together tow ball mounts that are completely adjustable from changing tow ball heights and angles, to suit different application. The left and right sway control mounting facility is already provided should you later require a sway control kit for additional towing comfort and safety. All necessary parts come with each WDH including hook-up brackets, spring bars, chains, tow ball mount, hitch pin and a clip and bolt package for adjusting your hitch. Rated for trailer masses of up to 3.5t. Limited lifetime warranty. Please note shanks are sold separately.

350-05600

EAZ LIFT 600 SERIES

For tow ball weights of up to 272kg - for use with a standard 7/8" (22.23) tow ball mounting hole. Shank sold separately



350-05610

EAZ LIFT 800 SERIES

For tow ball weights of up to 363kg - for use with a standard 7/8" (22.23mm) tow ball mounting hole. Shank sold separately.



350-05720**EAZLIFT SHANK SOLID
ADJ HI-LOW 3 HOLES
2"X12"L**

The 3 hole shank combines both the LONG and SHORT shank into one unit. Can be used in either the raised or dropped position to match the ball mount to any coupler height.

Low mounted: + 45mm lift / + 135mm lift
High mounted: + 135mm lift / + 225mm lift

**350-05724****EAZLIFT SHANK ADJ
EXTRA HI-LOW 3 HOLES
2"X12"L**

The 3 hole shank combines both the LONG and SHORT shank into one unit. Can be used in either the raised or dropped position to match the ball mount to any coupler height.

Low mounted: - 50mm lift / + 40mm lift
High mounted: + 225mm lift / + 315mm lift

**350-05728****EAZLIFT SHANK ADJ
EXTRA LOW ONLY 3 HOLES
2"X12"L**

The 3 hole shank combines both the LONG and SHORT shank into one unit. Can be used in either the raised or dropped position to match the ball mount to any coupler height.

Low mounted:
- 50mm lift / - 140mm lift

**350-05730****EAZLIFT BM35KAR -
ADJUSTABLE BALL-MOUNT
ATTACHMENT W/ANTI-
RATTLE 3500KG**

The EazLift Adjustable Ball Mount is the ultimate height adjustable trailer hitch. It offers a huge range tow ball height adjustment, up to 680mm across EazLift's range of compatible shanks.



**Shank not included*

This simple and easy to use adjustable tow shank uses a pin and r-clip system rather than nuts and bolts allowing for effortless installation, adjustment and removal. Designed and tested in Australia, the Adjustable Ball Mount meets and exceeds ADR requirements and is rated up to 3,500kg.

- > Reversible shank and ball platform allow for a huge range of drop or rise heights
- > Up to 40 levels of adjustment across EazLift's range of compatible shanks.
- > 3,500kg Maximum Gross Trailer Mass to cover the biggest vehicle and trailer combinations utilising a 50mm Tow-Ball.
- > Designed, tested and certified for use in Australia.
- > Anti-Rattle Grub Screw
- > Genuine EazLift accessory, it is only recommended & warranted for use with genuine EazLift Shanks only.

SPECIFICATIONS

Designed and tested in Australia

Exceeds the design and testing requirements for AS4177.1:2004 and ADR61/02

MAX Rise 302mm when used with EazLift Extra Hi shank (350-05724)

MAX Drop 387mm when used with EazLift Extra Low shank (350-05728)

Maximum Towball Down Load: 350kg

Maximum Gross Trailer Mass: 3,500kg

SHANK SELECTION GUIDE FOR EAZ LIFT WDH'S

Step 1. Ensure that both Tow vehicle and Caravan/Horse Float/Trailer are sitting on level ground.

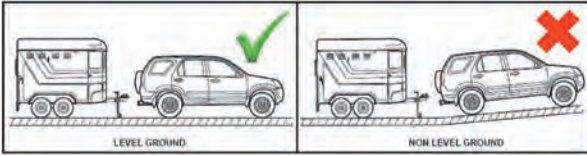

Step 2. Level the Caravan/Horse Float/Trailer with the aid of the jockey wheel and take the below measurements.

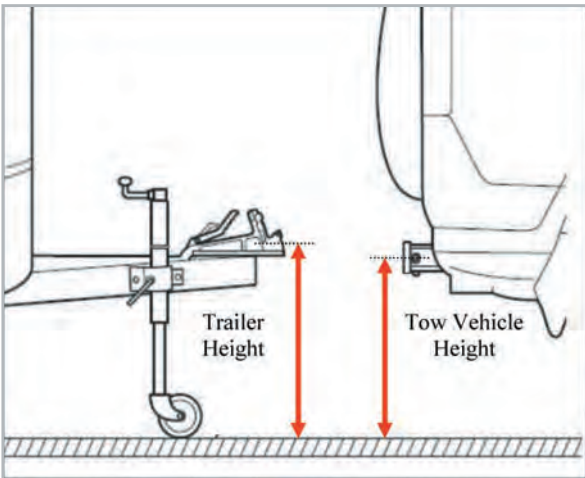

Trailer Height = 445mm
Tow Vehicle Height = 400mm
A +45mm lift is required from the Shank.

Example 1 $445\text{mm} - 400\text{mm} = +45\text{mm}$

| | | | | |
|----------------|---|-------------|---|---------------|
| Trailer Height | - | Tow Vehicle | = | Required Lift |
|----------------|---|-------------|---|---------------|

Example 2 $370\text{mm} - 450\text{mm} = -80\text{mm}$

| | | | | |
|----------------|---|-------------|---|---------------|
| Trailer Height | - | Tow Vehicle | = | Required Lift |
|----------------|---|-------------|---|---------------|

EAZ LIFT SWAY CONTROLS

Eaz Lift screw on sway controls minimise the sway caused by passing trucks and sudden gusts of wind. It works by using a double friction disc brake principle which provides constant sway reduction and therefore improves handling. They are attached with easy socket and spring clip connectors which also make them easy to remove for convenient storage. The slide bar is zinc plated which ensures consistent smooth gliding action.

Note: Trailers/ caravans over 24' may require two sway controls.

350-05800

EAZ LIFT SCREW-ON SWAY CONTROL (DRIVERS SIDE/ RIGHT HAND MOUNTED)



350-05810

EAZ LIFT SCREW-ON SWAY CONTROL (PASSENGER SIDE/LEFT HAND MOUNTED)



EAZ LIFT SPARE PARTS

350-05900

EAZ LIFT BALL MOUNT FOR 2" SQ SHANK WITH LOCK CLIPS



350-05901

EAZ LIFT BALL MOUNT WITH 1-1/4" BALL HOLE



350-05902

EAZ LIFT HITCH PIN



350-05908
EAZ LIFT SPRING BAR 272KG RATING
(600 SERIES)



350-05920
EAZ LIFT SET SCREW
FOR 272-363 BALL MOUNT



350-05909
EAZ LIFT SPRING BAR
363KG RATING (800
SERIES)



350-05922
EAZ LIFT SPRING BAR LOCKING
DEVICE REPAIR KIT



350-05910
EAZ LIFT HOOK UP WIRE
CLIP 2PC FOR 48029



350-05924
EAZ LIFT U-BOLT ONLY FOR CHAIN
PACKAGE SOLD PER PAIR



350-05936
EAZ LIFT CHAIN PACKAGE



350-05925
EAZ LIFT SWAY CONTROL
BALL MOUNT PLATE WITH
HOLE



350-05914
EAZ LIFT QUICK HOOK-UP



350-05926
SWAY CONTROL BALL, WASHER
& NUT CLAMSHELLED



350-05916
EAZ LIFT SET SCREW (HOOK-UP)



350-05928
EAZ LIFT LEVEL BAR



350-05918
EAZ LIFT BOLT PACKAGE
FOR 272-363



350-05930
EAZ LIFT TRAILER TONGUE
BALL PLATE



SOME EAZ LIFT WDH QUESTIONS

How do I work out if I require the 600 or 800 series hitch?
Use the guide below to help you determine what size hitch you need:

- > Determine the ball weight of the trailer - ball weight includes the trailer ball weight with full gas, water, waste systems and a packed trailer.
- > Estimate the car boot load - be sure to include all items carried in the back of the vehicle.
- > Match the sum of these weights to the Correct EAZ-LIFT® Hitch - For example, a ball weight of 500lbs (227kg) coupled with a car boot load of 200lbs (90kg) equates total hitch weight of 700lbs (317kg).

From the guide above, this example of vehicle-trailer combination would require an Eaz Lift 800 Series WDH - 800 Series for weights higher than 272kg and up to 363kg. Make sure the ball weight and the gross trailer weight do not exceed the tow vehicle manufacturer's recommended capacities. The hitch selected must have a maximum Gross Trailer Weight rating equal to or greater than the trailer rating. Ball weight is generally 10% of gross trailer weight.

Towing Tips

All trailers, including caravans, affect the performance of the towing vehicle. They affect fuel consumption, acceleration, braking ability, general control and maneuverability. These effects worsen as the size and weight of the trailer increase relative to that of the towing vehicle. The extra length and width can be hard to manage, with wind, road roughness and passing vehicles having a greater effect than on the vehicle alone. This puts additional responsibilities on a driver.

The following information applies to vehicles not exceeding 4.5 tons gross vehicle mass (GVM).

Rules for Towing

- > Towing more than one trailer at a time is not allowed
- > Nobody is allowed to ride in trailers or caravans
- > When towing and driving on a road without street lights, drive at least 60m behind heavy vehicles or other vehicles towing trailers, unless overtaking
- > Learner drivers and learner and provisional motorcycle riders are not allowed to tow
- > P1 car license holders can tow small trailers with up to 250kg of unloaded weight.

Remember

- > Allow longer distances for braking, overtaking and joining a traffic stream
- > When reversing, it is advisable to have someone outside the vehicle giving directions
- > Look further ahead than normal so you can react to changes in traffic or road conditions
- > Use a lower gear when travelling downhill to increase vehicle control and reduce strain on brakes
- > Slow down well before entering corners and curves
- > Trailers tend to jerk the back of the vehicle around and can cause sway (snaking). If a trailer starts to sway, the vehicle's brakes should not be applied, except as an absolute last resort. If the trailer's brakes can be operated by themselves they should be applied gently, otherwise a steady speed or

slight acceleration should be held if possible until the sway stops

- > Take care not to hold up traffic unnecessarily
- > Plan more rest stops and shorter travelling days as towing is more stressful and tiring than normal driving
- > There is no specific speed restriction while towing a trailer. However, the posted speed limits must not be exceeded. Always drive to the road, traffic and weather conditions.

Before each trip, check

- > Vehicle and trailer are roadworthy.
- > All tyres are properly inflated.
- > Trailer's wheel-bearings, suspension and brakes work properly.
- > All lights work and safety chains are properly connected.
- > Oil, water, brake fluid, battery and other service checks on the vehicle.

At regular intervals during the trip, check

- > Couplings, all doors, hatches, covers and any load or equipment are still properly secured.
- > If travelling to another State, check with the relevant roads authority whether there are different rules.

The Towing Vehicle

Vehicles must be suited to the trailer. Vehicle manufacturers usually indicate in the owner's manuals the maximum weight and other features of trailers appropriate for the vehicle. These limits should not be exceeded.

Registration

- > All vehicles must comply with all relevant standards for registration and be roadworthy at all times
- > Rear number plates and lights must not be obscured by the tow bar when there is no trailer connected.

Towing vehicles must be properly equipped with:

- > Tow bars and couplings of a suitable type and capacity
- > Electrical sockets for lighting
- > Brake connections if the trailer is fitted with power or electric brakes

Additionally

- > For vehicles with automatic transmission, an extra transmission oil cooler may be needed
- > Some vehicles need structural reinforcement and/or special suspension and transmission options and load-distributing devices to be able to tow heavier trailers.

Tow Bar

A properly designed and fitted tow bar is essential for towing. The rated capacity of the tow bar and coupling should not be exceeded.

The tow bar should be clearly and permanently marked with its:

- > Maximum rated capacity
- > Make and model of the vehicle it is intended for or the manufacturer's part number
- > Manufacturer's name or trade mark.

This is compulsory for vehicles built after 1 January 1992. The exception is where the tow bar is a permanent part of the vehicle.

Tow bars must not protrude dangerously when there is no trailer connected

Load Equalizers

- > Help the vehicle retain normal suspension height and effective steering control
- > Transfer some of the weight from the tow bar to the front and rear suspension of the vehicle.

As load equalizers may overload the tow bar and its components, check with the tow bar manufacturer for advice before use.

The Trailer

Trailers must be a suitable size and type for their intended tasks. They must be built to meet the standards for registration. If a trailer is required to be registered it must be fitted with a rear number plate.

Towing Ratio Requirement

The loaded mass of the trailer must not exceed the lesser of:

- > Rated capacity of the tow bar and tow coupling.
- > Maximum towing capacity of the vehicle.
- > Maximum carrying capacity of the trailer.
- > Maximum rated carrying capacity of the tyres.

If the vehicle manufacturer has not specified the maximum towing mass, the maximum towing mass is:

- > One and a half times the unladen mass of the towing vehicle, provided that the trailer is fitted with brakes which are connected and in working order, or
- > The unladen mass of the towing vehicle if the trailer does not require brakes. Vehicles with a manufacturer's gross combination mass (GCM) more than 4.5 tons may tow in accordance with the above requirements. The GCM is the gross combination mass of the car and loaded trailer.

Braking System

The minimum braking system for a trailer depends on the type of trailer, its weight and the weight of the vehicle:

- > 0 - 750 kg loaded weight - no brakes required.
- > 751 - 2000 kg loaded weight - braking on both wheels on at least one axle.
- > 2001- 4500 kg loaded weight - braking on all wheels, and an automatic breakaway system in case the trailer becomes detached from the vehicle.

Brakes must be operable from the driver's seating position.

Towing Coupling

All couplings:

- > Must be strong enough to take the weight of a fully loaded trailer.

- > Should be marked with the manufacturer's name or trade mark and rated capacity.
- > Must be equipped with a positive locking mechanism. The locking mechanism must be able to be released regardless of the angle of the trailer to the towing vehicle.

Safety Chains

- > Must comply with Australian Standards.
- > Trailers less than 2500kg when loaded must be fitted with at least one safety chain.
- > Trailers over 2500kg when loaded must be fitted with two safety chains.

To prevent the front end of the drawbar from hitting the ground if the coupling is disconnected, safety chains must be:

- > As short as practicable and connected to the towing vehicle.
- > Crossed over if two chains are fitted.

Loading Trailers

It is important that trailers are not overloaded and that loads are properly secured to or contained within the trailer:

- > A load must not project more than 150mm beyond the trailer's width or be more than 2.5m overall width, whichever is less.
- > Loads that project more than 1.2m behind a trailer must have a red flag attached to the end of the load. This flag must be at least 300 mm square and clearly visible. To avoid having an overhanging load, you should purchase a trailer that suitably contains the load.
- > Overall length of the vehicle and trailer combination including its load must not be more than 19m.
- > To reduce sway, heavy loads should be concentrated towards the centre of the trailer.
- > Loads should be kept as low and as close as possible to the axle or axles with about 60% of the total weight forward of the centre of the axle or axles. As a general rule, about 5-10% of the total mass of the trailer plus load should be supported by the vehicle through the coupling. The trailer drawbar should be level or slightly 'nose down'.

Source:

<http://www.rms.nsw.gov.au/roads/safety-rules/road-rules/towing.html>

(11 June 2015).

PEDALBOX ELECTRONIC THROTTLE CONTROLLER RANGE



PedalBox throttle controllers are the newest tool to help you drive smoothly and more effectively. They remove delays in the accelerator to help you manoeuvre your car easily, even when towing or on difficult terrain!

Our throttle controllers alter the acceleration curve on electronic throttle controlled vehicles. They digitally alter the shape of the curve increasing throttle response and improving your overall driving experience. There are four driving modes, Off, Sport+, Sport and Eco/City and each mode can be optimised by a further six levels of curve control. This means that the settings can be adjusted to best suit your driving style.

- > A huge range of cars, 4WDs, vans and trucks supported
- > Improved throttle response for all vehicle types
- > Simple installation and removal—leave no trace
- > Made in Germany for quality guarantee
- > Two year warranty for peace of mind

| Part Number | Description |
|------------------|--|
| 350-13735 | PedalBox Throttle Controller For Mitsubishi Challenger 2.5CRD/Triton 2.5CRD/Pajero 3.2CRD. |
| 350-13762 | PedalBox Throttle Controller For Toyota LC76,78,79 D4-D No Airbag / Hilux D4-D / Prado 120 D4-D / FJ Cruiser. 3762 |

| Part Number | Description |
|------------------|--|
| 350-13701 | PedalBox Throttle Controller For Toyota Hilux/ Fortuner 2.8 CRD. 3701 |
| 350-13705 | PedalBox Throttle Controller For Ford Ranger-Mazda BT-50 2.5 & 3.0 CRD. 37005 |
| 350-13708 | PedalBox Throttle Controller For VW Amarok 2.0CRD/Porsche Cayene(All)Ford Territory 2.7CRD |



ETOURER M-SERIES

350-06750
ETOURER M-SERIES
MX1 MID-DRIVE
95NM HT MOUNTAIN
BIKE - MATT BLACK

The eTOURER MX1 is made for adventure seekers and those looking to challenge the Australian outback. Its electrical assistance is activated by a premium Bafang M500 Mid Mount motor and features hydraulic disc-brakes, giving you command over your chosen terrain.



SPECIFICATIONS

ELECTRICAL SYSTEMS

Motor: Bafang M500 250W

Display: Bafang DP C10

PERFORMANCE

Max Torque: 9.5Nm

COMPONENTS

Colour: Matt Black

Frame: 27.5" 6061 Alloy Aluminum

Fork: SR-Suntour XCM Adjustable Suspension

Derailleur: SRAM NX 1X11SPD 11 Speed

Brake: Tektro HD-M290 Hydraulic Disc-Brake

Tyres: 27.5*2.1 Kenda Anti Puncture Tire

350-06752
ETOURER M-SERIES
CX1 MID-DRIVE 80NM
HT HYBRID BIKE -
MATT BLACK

Designed for the busy commuter, getting to work has never been easier with the eTOURER CX1. Its electrical assistance is activated by a premium Bafang M400 Mid Mount motor and features mechanical discbrakes, making your ride the envy of others as you take to the streets on the CX1.



SPECIFICATIONS

ELECTRICAL SYSTEMS

Motor: BBafang M400 250W

Display: Bafang DP C07

PERFORMANCE

Max Torque: 80Nm

COMPONENTS

Colour: Matt Black - Silver

Frame: 26" 6061 Alloy Aluminum

Fork: SR-Suntour NEX Adjustable Suspension

Derailleur: SRAM 12RD X5 9S Long Cage 9 Speed

Brake: Tektro MD-M280 Mechanical Disc-Brake

Tyres: 26*2.1 Kenda Anti Puncture Tire

ETOURER M-SERIES
SX1 MID-DRIVE 80NM
HT HYBRID BIKE

The eTOURER SX1 is built for those who want to push the limits of their journeys. With speed-activated pedal assistance and 7 powerful gears, the SX1 will keep you going further, for longer, so you can spend time doing the important things.

350-06754
Matt Black
350-06756
Silver

SPECIFICATIONS

ELECTRICAL SYSTEMS

Motor: Bafang M400 250W

Display: Bafang DP C07

PERFORMANCE

Max Torque: 80Nm

COMPONENTS

Colour: Matt Black - Silver

Frame: 26" 6061 Alloy Aluminum

Fork: SR-Suntour NEX Adjustable Suspension

Derailleur: SRAM 12RD X5 9S Long | Cage 9 Speed

Brake: Tektro MD-M280 Mechanical Disc-Brake

Tyres: 26*2.1 Kenda Anti Puncture Tire

A series of horizontal dotted lines for writing notes.

A series of horizontal dotted lines for writing notes.

SECTION 3

CARAVAN ACCESSORIES

(Product Group - 400)

| | |
|--------------------------------|-----------|
| Dinnerware | 104 - 105 |
| Caravan Accessories | 106 - 110 |
| First Aid | 110 |
| Table Legs and Components | 111 - 113 |
| Picnic Tables | 114 - 116 |
| Roof Racks and Accessories | 117 - 118 |
| Security Handles | 118 - 119 |
| ADCO RV Covers and Tyre Guards | 120 - 122 |
| Cleaning Products | 122 - 123 |

CHASSIS EQUIPMENT

(Product Group - 450)

| | |
|-------------------------------------|-----------|
| Trail-A-Mate | 123 - 124 |
| Jacks and Levels | 124 - 128 |
| Jockey Wheels and Accessories | 128 - 131 |
| Trailer Locks | 131 - 132 |
| Steps | 132 - 134 |
| Wheel Spats | 135 |
| Hub Kits and Accessories | 135 - 137 |
| Bearings and Seals | 137 - 139 |
| Level Indicators | 140 |
| Heavy Duty Couplings | 141 |
| Shackles and Couplings | 142 - 143 |
| Corner Steadies | 143 - 144 |
| Shackle Pins and Nuts | 144 - 145 |
| Tow Ball Scales and Weight Controls | 145 |
| Purpleline Levellers and Security | 146 - 148 |
| Milenco Levellers | 149 |
| Stone Shields | 150 - 151 |



COAST 100% MELAMINE 16PCS DINNER SETS



Great for travelling, these lightweight and chip resistant melamine dinner sets are available in two modern designs. They are not suitable for use in a microwave but they are dishwasher safe (top rack only).

400-00264

COAST 100% MELAMINE 16PCS DINNER SET - DESTINATIONS

Set includes 4 of each:

- > Dinner Plates
- > Side Plates
- > Bowls
- > Coffee Cups



400-00262

COAST 100% MELAMINE 16PCS DINNER SET - DANDELIONS

Set includes 4 of each:

- > Dinner Plates
- > Side Plates
- > Bowls
- > Coffee Cups



CAMCO MELAMINE RANGE

The "Life is Better at the Campsite" range is white with a multi-color RV and truck design. The durable dinnerware is great for boats, RVs, and camping. The "Life is Better at the Campsite" range is easy to clean and is top rack dishwasher safe, and BPA free. Do not use in the microwave.

- > Multi-color RV and truck design
- > Melamine construction makes the pieces virtually unbreakable
- > Top rack dishwasher safe and BPA free
- > Perfect for boats, camping and RVs
- > Sold in boxes of 12

400-00300
CAMCO MELAMINE
BOWL - RV PATTERN



400-00302
CAMCO MELAMINE
SALAD PLATE
- RV PATTERN



400-00304
CAMCO MELAMINE
DINNER PLATE
- RV PATTERN



The "Life is Better at the Campsite" range is white with a blue tree and truck design. The durable dinnerware is great for boats, RVs, and camping. The "Life is Better at the Campsite" range is easy to clean and is top rack dishwasher safe, and BPA free. Do not use in the microwave.

- > Blue tree and truck design
- > Melamine construction makes the pieces virtually unbreakable
- > Top rack dishwasher safe and BPA free
- > Perfect for boats, camping and RVs
- > Sold in boxes of 12

400-00306
CAMCO MELAMINE
BOWL - TRAILER/TREE
PATTERN



400-00308
CAMCO MELAMINE
SALAD PLATE
- TRAILER/TREE
PATTERN



400-00310
CAMCO MELAMINE
DINNER PLATE
- TRAILER/TREE
PATTERN



400-90000N

BOATIES FRYPAN

Designed for use in RVs where stove and cooking space is limited, the Boaties Frypan has a rectangular shape and is made of heavy gauge aluminium. This, combined with a double layer of non-stick coating, creates a quality frypan with excellent heat transfer and even cooking temperatures. The handle is compact and has an ovenproof (max oven temperature: 220°C) silicone grip—remember to take care as the grip will get very hot! The front edge is conveniently sloped whilst the rounded corners make pouring liquid contents easy. Suitable to use on gas, electric and induction hobs.



SPECIFICATIONS

Dimensions: 25L x 20W x 4.5H (cm)

400-90010N

BOATIES BAKING PAN

The Boaties Baking pan has all the same structural features as the Boaties Frypan (above) except that it is slightly larger and has a detachable silicone grip handle. With the Boaties Baking pan, you're able to roast and bake. Meals can be prepared on the stove top and then transferred to the oven for cooking.



SPECIFICATIONS

Dimensions: 21L x 31W x 6D (cm)

400-90020N

BOATIES FRYPAN LID

The Boaties Frypan Lid is made from stainless steel and is suitable for use on the Boaties Frypan only. It stops splatter and enables the Frypan to be used as a stovetop casserole dish. It also features a handy steam vent.



400-00495

FIAMMA EASY DRY

Suitable for use with any Fiamma Carry Bike, the Easy Dry is quickly installed onto the rail support base, without the need to drill anything. It can also be used on other bike carriers, provided their tube diameter is 35mm. The Easy Dry is a great option to dry towels or swimmers as they come with plasticized ropes and the width is adjustable for slightly larger items. It is made from anodized aluminium with a 22mm diameter, making it sturdy but lightweight. Has eight lines.

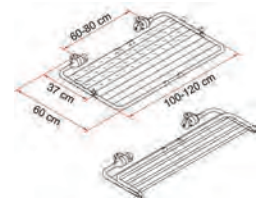

SPECIFICATIONS

Length (cm): Adjustable from 100 - 120

Closed Width (cm): 37

Open Width (cm): 60

Weight (kg): 1.2

400-00530

RV & MARINE MINI DISH DRAINER

Fits RV sinks & is sized just right for limited counter space. Its sloped drainer tray keeps counters dry. When your dishes are dry, simply snap the drain tray back onto the top of the rack for handy storage. Made from a durable, heavy duty plastic it even has space for utensils.



400-00546

CAMCO STACK-A-PLATE

The Stack-A-Plate keeps your plates tidy and safe during travel. It features a non-slip backing thus eliminating movement whilst stowed in your RVs cupboard. Made from plastic, the Stack-A-Plate is available in bright white and is even safe for the top rack of your dishwasher. Comes as a two-piece set - the larger of which fits plates up to 26cm in diameter and the smaller one fits plates up to 18.4cm in diameter.



400-00642

POP-A-BAG HOLDER

Stores grocery bags efficiently. The plastic bag holder/dispenser mounts easily onto walls or inside cabinets with screws or double-sided tape. Comes in white & holds up to 25 grocery bags.



400-00650

ADJUSTABLE BROOM WITH CLIP ON DUST PAN

Full size broom telescopes down to store compactly. Soft-bristled head adjusts to different angles for maximum cleaning power. The handle length is adjustable from 61 - 132(cm) & the dustpan clips onto the broom handle for storage.



400-00654

RV FOLDING IRONING BOARD

A wooden tabletop ironing board with fabric cover that is small & easy to use. It features a sturdy chrome-wire iron rest & measures 81L x 30W (cm) when set up for use.



400-00656

RV WALL MOUNT TRASH CAN

A compact trash can that can be mounted onto a wall or inside a cabinet. Features a handy swing-top lid & comes with screws for mounting.



SPECIFICATIONS

Dimensions: 13W x 28H (cm)

CAMCO FRIDGE ACCESSORIES

400-00690

FRIDGE BRACE

Keep food from sliding as you travel. The Fridge Brace helps to keep cartons upright to reduce the risk of messy spills. Comes in a pack of 2.



SPECIFICATIONS

Weight: 145g

Dimensions: 73D x 130W x 135H (mm)

400-00692

DOUBLE FRIDGE BAR

Keep order in your RV's fridge whilst travelling. These spring-loaded bars keep items in place and extend from 406 - 711 (mm).

SPECIFICATIONS

Weight: 295g

Dimensions: 19D x 102W x 476H (mm)



400-00694

REFRIGERATOR BARS

These are x3 single bars that act in the same manner as the Double Fridge Bar (above).

SPECIFICATIONS

Weight: 349g

Dimensions: 17D x 92W x 594H (mm)



400-00686

CAMCO FRIDGE AIRATOR WITH ON/OFF SWITCH

Camco RV Fridge Airator helps to cool the RV fridge evenly and keeps your food fresher. The Fridge Airator features a high-volume air circulator that absorbs odours with replaceable activated charcoal pack. Battery operated. Version with on/off switch available for easy use.



- > Absorbs odors with activated charcoal
- > Keeps food fresher by cooling your fridge evenly
- > On/off switch saves battery life
- > Perfect for any small sized refrigerator
- > Replaceable charcoal pack included
- > Runs on two size D batteries (not included)

400-00688

CAMCO FRIDGE AIRATOR CHARCOAL PACKS

Fridge Airator Replacement Charcoal Packs. Replace the charcoal pack monthly to stop odours and keep your Camco Fridge Airator working efficiently.



400-00696

CAMCO MINI ICE CUBE TRAY PACK OF 2

Small trays fit perfectly into RV or marine freezers. Provides small size cubes for quick freezing.



SPECIFICATIONS

Length: 22.86cm
Width: 10.16cm
Height: 2.54cm

400-00850

FIAMMA SOAP DISPENSER

A 200ml refillable liquid dispenser ideal for soap or shampoo. The container is transparent which helps to identify when you're running low. Its heavy duty push style pump ensures no mess with every use.



SPECIFICATIONS

Dimensions: 150H x 8D x 55W (mm)

FLAT OUT STORAGE REELS

Flat Out Storage Reels were made for the harsh Australian environment. They are the ideal storage solution for electrical leads or any of the Flat Out Hoses. Made from a grey, impact resistant plastic, they feature a turning handle (to assist with winding up) & a grip handle for comfortable carrying. Great for domestic, travelling & even the construction industry, they come with a Flat Out limited 3 year guarantee.

400-00700

FLAT OUT MULTI-REEL

- Can hold one of the following:
- > 40m of heavy duty power lead
 - > 18m of flat drink water hose
 - > 9m of flat sullage hose
 - > 375 x 80 (mm)



400-00710

FLAT-OUT BARE COMPACT-REEL

- Can hold one of the following:
- > 20m of heavy duty power lead
 - > 12m of flat drink water hose
 - > 7m of flat sullage hose
 - > 300 x 65 (mm)



400-00800

FIAMMA OMNI STOP

An innovative yet simple accessory, ideal for keeping plates & items in place as you travel. Easy to lock & unlock, the securing bar is made from anodized aluminium & is 25cm high. The support handle is made from a sturdy plastic & is 20cm long.



400-00900

FIAMMA MOSQUITO NET FOR MOTORHOMES & CARAVANS

The mosquito net consists of two overlapping panels, each being 230 x 35 (cm). The bottom of each panel is reinforced & stays taught. It is easily installed by sliding into the wall track provided.



POLE CARRIERS & ACCESSORIES

400-01100
POLE CARRIER (200CM X 15CM)

Comes with a pair of mounting brackets - great storage place for fishing rods, annex poles or even cable for the humble tradie.



400-01102
POLE CARRIER (200CM X 10CM)

Comes with a pair of mounting brackets.



400-01110
SINGLE BRACKET (150MM)

For pole carrier - sold separately.

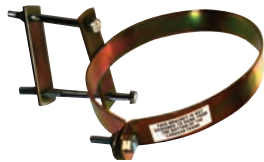

400-01120
POLE CARRIER END CAP

To suit 400-01100



400-01130
POLE CARRIER END PIN ASSEMBLY

To suit 400-01100 (15cm diameter)



400-01132
POLE CARRIER END PIN ASSEMBLY

To suit 400-01102 (10cm diameter)



400-01140
SINGLE BRACKET (100MM)

To suit pole carrier (suits part number 400-01102) - sold separately.

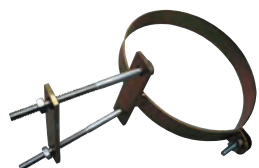

COAST CARRIERS COAST CARRIERS

If you're tired of wrapping cable or hose around your elbow to tidy up an area and then worry about where to store it, then the Coast range of Carriers is what you need. Made from a durable mesh and a vinyl front, each bag comes with a convenient handle to either hang somewhere for storage or for easy transportation. Available in 3 sizes.

400-01510
ELECTRIC CABLE CARRIER

Holds up to 20m of cable

SPECIFICATIONS

Dimensions: 270mm Diameter



400-01520
DRINK WATER HOSE CARRIER

Holds up to 20m of drink hose

SPECIFICATIONS

Dimensions: 345mm Diameter



400-01530
GREY WATER HOSE CARRIER

Holds up to 10m of grey water hose (with 27mm diameter)

SPECIFICATIONS

Dimensions: 440mm Diameter



400-02210

1KG ABE FIRE EXTINGUISHER

Australian standard approved, this fire extinguisher is rechargeable & lightweight. It has a mounting bracket for convenient storage & is suitable for use in vehicles, boats, RV's, residential, garages, workshops & the like.



SPECIFICATIONS

Fire rating: 1A1ØBE

Range of discharge: 3-4m

400-02220

FIRE BLANKET

Suitable for cooking & clothing fires the blanket measures 1 x 1m



400-02250

FIRE EXTINGUISHER HOLDER MAPLE

Made from a 3mm ABS plastic this holder is a suitable housing for the 1kg Fire Extinguisher (part number: 400-02210). The cavity measures 135W x 345H x 95D (mm).



400-02252

FIRE EXTINGUISHER HOLDER WHITE

The white version of the extinguisher holder above.



400-02254

FIRE EXTINGUISHER HOLDER BLACK 3MM ABS PLASTIC

400-02260

MINI FIRST AID KIT

Contains all the essentials: a first aid leaflet, a pair of latex gloves, a towel dressing, antiseptic wipes, non adherent dressing, a crepe bandage, gauze swabs & splinter forceps.



400-02292

CARAVAN & RV OWNERS HANDBOOK WALLET

- > Professional, sleek all black document wallet.
- > Perfect way to store owner manuals, receipts, cards & service logs
- > Cheap, presentable way to bundle in all handover paperwork
- > Clear plastic pockets for business cards and elastic pocket for A4 documents.



400-02310

WINEGLASS TABLE LEG COMPLETE WITH BASE & TOP

Popular table leg which stands 70cm tall. Comes in 4 parts - top plate, tube, bottom plate & anchor (which is bolted to the floor for extra stability). Powder coated in a neutral beige paint.



TABLE LEGS

400-02400

SWING AWAY TABLE LEG

Comes complete with base & top. Has a sturdy construction with a chrome finish. Stands 73cm high.



FIAMMA TABLE LEGS & PARTS

400-02362

FIAMMA TABLE LEG TRIPOD PRO

A newly reinforced and more stable tripod promoting carrying the table outside. Made from UV resistant plastic, it comes standard delivered with an anti-closing device.



400-02402

EAZY LIFT TABLE LEG

A height adjustable table leg with an adjustable collar for specific heights. Functioned by a single gas strut & requires 22kg to compress or increase height.



SPECIFICATIONS

Height Range: 48 - 85.5 (cm)

400-02364

FIAMMA TABLE LEG RECESSED BASE



400-02403

EAZY LIFT TABLE LEG WITH ROUND PLATE

All the same features as 400-02402 (above) but now comes with a round base plate.



SPECIFICATIONS

Height Range: 48 - 85.5 (cm)

400-02366

FIAMMA CONIC TOP MOUNT CONNECTION

Made of aluminium & supplied with self threading fixing screws.



400-02409

WING NUT HANDLE FOR SWING AWAY TABLE LEG



400-02368

FIAMMA RECESSED BASE PLUG

Covers the hole in the centre of the recessed base - part number 400-02364.



400-02412

V-TYPE TABLE LEG

Stands 705mm in height & has x4 predrilled screw holes.



400-02370

FIAMMA TABLE LEG TUBE PRO (70CM)

This new leg is made of anodized aluminium with a 70cm max extension. It comes with 2 plastic joint caps.



400-02414

TABLE SUPPORT LEG - 305 (MM)



3 SECTION

TABLE LEGS & COMPONENTS

400-02416
TABLE SUPPORT LEG - 355 (MM)



400-02418
TABLE SUPPORT LEG - 457 (MM)



400-02420
PLASTIC HINGE
To suit 400-02414, 400-02416 and 400-02418.



400-02422
WINE GLASS EXTENSION IN GREY HAMMER-TONE (140MM)

Suitable for use on an existing straight table leg, this extension converts a normal table top to a swivel table top. Simply remove the existing table top (and plate), and place the extension piece into the top of the existing table leg. Tighten the wingnut to secure the extension piece into place. Refit the table top (and plate) on the extension piece. Fits all table legs with a 45mm tube diameter.

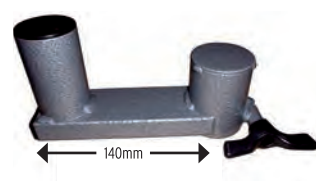

400-02424
WINE GLASS EXTENSION IN GREY HAMMER-TONE (215MM)

Suitable for use on an existing straight table leg, this extension converts a normal table top to a swivel table top. Simply remove the existing table top (and plate) and place the extension piece into the top of the existing table leg. Tighten the wingnut to secure the extension piece into place. Refit the table top (and plate) on the extension piece. Fits all table legs with a 45mm tube diameter.

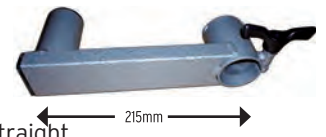

NUOVA MAPA TABLE LEG AND SLIDE



The Nuova Mapa table leg is a fully adjustable telescopic table leg with turntable and slide system. This table can be easily adjusted into bed position if required. The bed position is factory set at 330mm and can be easily adjusted if another measurement is required.

400-02600

NUOVA MAPA TELESCOPIC AND ADJUSTABLE TABLE LEG (WITH TURNTABLE/SLIDING TABLETOP MECHANISM)

Encompassing ease and versatility, this revolutionary table leg is made in Italy from galvanised steel. Its spring loaded leg, can be lowered by pressing on the foot pump at the base and pushing down on the table top. Raising the table top is just as simple - press the foot pump again. The table top mechanism, made from lightweight aluminium, facilitates movement in and out of the dining area. A lift lever allows the table top to swivel up to 180°, as well as in a N, S, E or W direction.

SPECIFICATIONS

Diameter of leg base: 260mm
 Max Weight Capacity (in bed position): 100Kg
 Max Height (from floor to underside of table top): 710mm
 Min Height (from floor to underside of table top): 330mm



400-02602

NUOVA MAPA BLACK ADJ HEIGHT TABLE LEG WITH TURN TABLE & SLIDE



400-02610

NUOVA MAPA SLIDING TABLE TOP MECHANISM

Suitable for use on existing Wineglass table legs, the Sliding Mechanism retrofits in place of the standard (and immovable) table top mount.

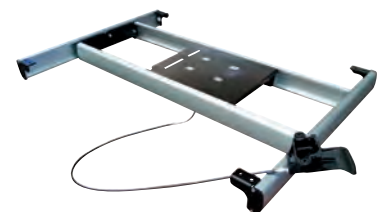

SPECIFICATIONS

Dimensions: 445W x 705L (mm)

400-02612

NUOVA MAPA TABLE TOP SLIDING MECHANISM REPLACEMENT WIRE AND HANDLE

COAST PICNIC TABLES



We all know storage space is at a premium whilst you're travelling, so taking the essentials (like tables and chairs) can sometimes be a pain. Why not install a picnic table on the outer wall of your RV? It's one less thing you have to pack and you can never leave it behind! Quick and easy to install, the Coast Picnic Tables feature powder coated, stainless steel hinges and are rated to a huge 30kg*. The table itself is made from SMC (sheet moulding compound) which is the same material used by Audi and Porsche! Available in white, the Coast Picnic Tables are suitable for installation on fibreglass and aluminium cladded RVs (note that in the case of aluminium cladded vans, the Picnic Table with Backing Plate must be installed). Comes with 2 keys so that you can lock your table in a "closed" position when not in use.

**Whilst the Coast Picnic Tables are rated to hold 30kg, you should ensure that the structure you're fitting it onto (i.e. aluminum cladding or fibreglass paneling) can hold that weight. Coast recommends that you: 1) Check with your RV's manufacturer, prior to installation, how much weight the walls will hold. 2) Ensure you do not exceed the weight that your RV manufacturer has recommended.*

400-02700 PICNIC TABLE (WITH BACKING PLATE)

The backing plate creates a neat frame between the two fixed brackets on the picnic table. It Allows for extra mounting points should there not be any supporting studs behind the spot you've chosen to install it.



SPECIFICATIONS

Weight: 4.7Kg
Dimensions: 805L x 435H x 30D (mm)

400-02720 PICNIC TABLE (WITHOUT BACKING PLATE)

SPECIFICATIONS

Weight: 4.2Kg
Dimensions: 805L x 435H x 30D (mm)



400-02730
PICNIC TABLE WHITE C/W
CHROME LOCK
 Includes backing plate.

SPECIFICATIONS

Dimensions: 800 x 450 (mm)



400-02732
PICNIC TABLE BACKING
PLATE C/W 3M TAPE WHITE
 To suit 400-02730

SPECIFICATIONS

Dimensions: 800 x 450 (mm)



400-02740
PICNIC TABLE BLACK WITH
CHROME LOCK
 Includes backing plate.

SPECIFICATIONS

Dimensions: 800 x 450 (mm)



400-02742
PICNIC TABLE BACKING
PLATE WITH 3M TAPE BLACK
 To suit 400-02740

SPECIFICATIONS

Dimensions: 800 x 450 (mm)



CARAVAN PICNIC TABLE WITH LED LIGHTING & BACKING PLATE

Now featuring bright LED lighting, Coast Picnic Tables are quick and easy to install on fibreglass or aluminium clad vans. They feature powder coated stainless steel hinges, full size backing plate, chrome locks and have a 25Kg weight rating.

- > Integrated 12V LED Lighting
- > 304 Stainless Steel Locks
- > Improved Drainage with 12 Drain Slots

400-02800
CARAVAN PICNIC TABLE
BLACK 4RC WITH LED
LIGHTING & BACKING
PLATE

SPECIFICATIONS

Dimensions: 800 x 445 (mm)



400-02802
CARAVAN PICNIC TABLE
WHITE 4RC WITH LED
LIGHTING & BACKING
PLATE

SPECIFICATIONS

Dimensions: 800 x 445 (mm)



400-02804
CARAVAN PICNIC TABLE
RAL7037 GREY 4RC WITH
LED & BACKING PLATE

SPECIFICATIONS

Dimensions: 800 x 445 (mm)



400-02805
CARAVAN PICNIC TABLE
SOJL25678 LIGHT GREY
4RC WITH LED & BACKING
PLATE

SPECIFICATIONS

Dimensions: 800 x 445 (mm)



CARAVAN PICNIC TABLE WITH BACKING PLATE

400-02820
CARAVAN PICNIC TABLE
BLACK 4RC & BACKING
PLATE

SPECIFICATIONS
Dimensions: 800 x 445 (mm)



400-02822
CARAVAN PICNIC TABLE
WHITE 4RC & BACKING
PLATE

SPECIFICATIONS
Dimensions: 800 x 445 (mm)



400-02824
CARAVAN PICNIC TABLE
RAL7037 GREY 4RC &
BACKING PLATE

SPECIFICATIONS
Dimensions: 800 x 445 (mm)



400-02826
CARAVAN PICNIC TABLE
SOJL25678 LIGHT GREY
4RC & BACKING PLATE

SPECIFICATIONS
Dimensions: 800 x 445 (mm)



TABLE HINGE KITS

400-02900

TABLE HINGE KIT

Allows you to easily & quickly remove a table top. Kit includes: x1 metal rod (70cm), x2 plastic rod ends, x1 plastic bracket, x1 plastic bracket locator & x2 plastic removable hinges. Suitable for bi-fold tables.



COAST ADJUSTABLE ROOF RACKS

Designed to suit most campers, Coast to Coast's Adjustable Roof Racks can be resized to fit almost any installation requirement.

Now there is room to take your surfboards, canoe or kayak on your next adventure, even if you already have a roof mounted A/C or TV antenna!

Features

- > Easy Multi-fit DIY Roof Rack Kit
- > Can be shortened in both length and width to suit your requirements.
- > Cross bars can be positioned to allow for roof top accessories.
- > Each kit comes complete with the brackets for both roof and side mounting options.
- > Stylish low profile design is available in Black.
- > Lightweight and durable
- > Made from tubular aluminum.
- > Weight rated to 100kg*
- > Complete with all required fitting and detailed installation instructions.

SPECIFICATIONS

Weight: 20kg
 Maximum Load: 100kg*
 Maximum Length: 3745mm
 Maximum Width: 2300mm
 Height: 140mm

* Please consult your camper manufacturer for roof load limit

400-04602 COAST ADJUSTABLE ROOF RACK BLACK

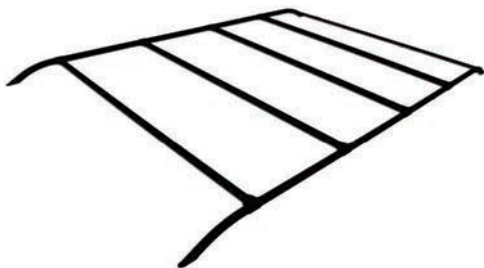

LUGGAGE BASKET

Suitable for Jayco and Coast roof racks, this handy luggage basket greatly expands the amount and type of cargo you can safely transport on your next RV adventure. Made from lightweight and durable tubular aluminum the basket is supplied preassembled with all required fittings for an easy installation.

SPECIFICATIONS

Weight: 12kg
 Maximum Length: 1500mm
 Maximum Width: 1000mm
 Height: 200mm

400-04610 ALUMINIUM LUGGAGE BASKET WHITE



400-04612 ALUMINIUM LUGGAGE BASKET BLACK



ROOF RACK CROSS BAR KIT

An extra cross bar with all required fixtures to add extra support to existing Jayco Roof Racks. Kit contains 4 brackets (1pair), 4 nuts and bolts and 1 cross bar. The bars are 2300mm long and can be cut to the correct length.

400-04614 ALUMINIUM CROSS BAR PACK FOR ROOF RACK WHITE



400-04616 ALUMINIUM CROSS BAR PACK FOR ROOF RACK BLACK



BIKE RACKS

Coast to Coast's range of Bike Racks feature a compact and sturdy design, excellent quality, well thought-out usability and outstanding value.

Coast Bike Racks are supplied pre-assembled for easy DIY installation and are specially designed to suit both Jayco and Coast to Coast adjustable roof racks.

Coast Bike Racks are an affordable and convenient solution to take your bikes with you on your next trip.

400-04650 COAST ALU STAR BIKE RACK

- > For upright assembly
- > Can be mounted to both Jayco and Coast Roof Rack Systems
- > Fast and easy installation by means of plastic hand wheels.
- > For 1 bike up to 133cm wheelbase and 80mm frame diameter
- > Supplied with extra mounting brackets that also suit car roof racks



SPECIFICATIONS

Load capacity: 15kg
Weight: 2.15 kg

400-04652 COAST SUPER BIKE RACK

- > For upright assembly
- > Can be mounted to both Jayco and Coast Roof Rack Systems
- > Plastic hand wheels for fast and easy installation
- > Suitable for bikes frames up to a width of 80mm
- > For almost all tyre widths, from racing bikes to mountain bikes
- > Swivel catch on the lockable toggle screw
- > Adjustable wheel holder trays with protective plastic end caps
- > Supplied with extra mounting brackets that also suit car roof racks



SPECIFICATIONS

Load capacity: 15kg
Weight: 2.9 kg

FIAMMA SECURITY HANDLES

A handle designed to lock across the main door to provide extra security & also double as a grab handle to get into your caravan comfortably. Available in two sizes.

400-03010 FIAMMA SECURITY 31 HANDLE (WHITE)

Made with solid painted aluminium with 30mm diameter & 2mm thickness. Takes up little space when folded against the wall. Comes complete with key lock & safety release handle, installation brackets, screws & internal counterbrackets.



400-03020 FIAMMA SECURITY 46 HANDLE (WHITE)

Has all the same features as the Security 31 Handle but with a longer handle extension.

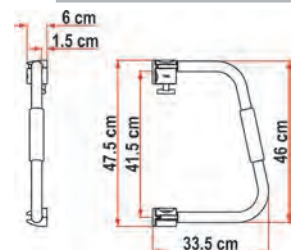

400-03090 FIAMMA DOOR HOLDER GREY

Prevents the door to your RV from swinging open/ closed when windy.

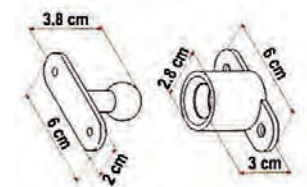

CAMCO RV GRAB HANDLES

The Camco RV Grab Handle is a simple, efficient way to make entering and exiting your RV safer. After the one-time, easy installation, the Camco RV Grab Handle provides a secure hand-hold on the left or right side of your RV door. When not in use, the Grab Handle easily lifts and rotates to lay flat against the side of the RV. The durable aluminum construction with UV resistant plastic brackets is built to last. Use the Camco RV Grab Handle to replace your old or broken grab handle, or to install on an RV that has never had a grab handle. All installation hardware is included.

- > Provides a secure hold for entering and exiting your RV
- > Easily installs to the side of any RV
- > Ergonomic design provides solid, secure grip
- > All installation hardware included
- > Durable and weather resistant

SPECIFICATIONS

Height: 72.9cm
Width: 37.6cm
Depth: 6.1cm

400-03030 CAMCO FOLD AWAY GRAB HANDLE - BLACK



400-03032 CAMCO FOLD AWAY GRAB HANDLE - WHITE



400-03054 FIAMMA SECURITY SAFE DOOR WHITE



400-03530 TOYLOK W/15FT CABLE + PADLOCK

Scavengers are everywhere. ToyLok's tamper-resistant design keeps your gear safe while you're away. Thanks to ToyLok, your belongings will be there when you get back.



SPECIFICATIONS

- > Easy, bolt-on installation
- > Built-in clutch prevents cable snap while retracting
- > 15 feet of PVC coated, anti-abrasion cable
- > Internal breaking and pulley system allows users to choose their optimum length of cable
- > 8,000 pound rated cables ensures your gear stays safe
- > Keys, padlock and mounting hardware included

FIAMMA STORAGE POCKETS

400-05000 FIAMMA STOW-ALL POCKET M

Made of scratch resistant plastic & is easy to install with the provided screws. Available in white only.



400-05004 FIAMMA STOW-ALL POCKET L

Made of scratch resistant plastic & is easy to install with the provided screws. Available in white only.

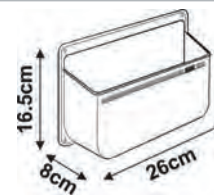

400-05010 FIAMMA STOW-ALL POCKET XL

A practical storage pocket that is easily installed onto doors or walls with screws provided. Made of scratch resistant ABS & is available in grey only.



ADCO RV COVERS

Australia and New Zealand has seen the new era of RV protection, thanks to the American RV cover giant ADCO making their newest Designer Series covers exclusively available from Coast to Coast. Backed by a huge 3-year warranty, the ADCO Designer Series Olefin HD™ RV Cover is available to suit Camper Trailers, Caravans, Pop Tops and Motorhomes. They're designed for high sun exposure, high moisture, long term storage and even snow, making it the most durable cover on the market! It features superior UV stabilised and breathable fabric that blocks out 99.8% of the suns damaging UV rays. On the Caravan, Pop Top and Motorhome models, there are zippered panels along one side. These allow you access to the interior of your RV whilst the cover is on, and because of the eyelets on these panels, they can also double as an awning!



FEATURES

- > Top panel is made of Olefin HD™ fabric. This new proprietary fabric has outperformed other leading roof materials and beads water on contact. Some water may penetrate the cover in heavy rains.
- > Side panels are made of four layers of polypropylene with a soft lining that won't scratch your RV paintwork.
- > A cinching system with buckles prevent billowing fabric on the front and rear.
- > The lining of the cover is reinforced on all corners to protect against tears caused by sharp edges.
- > Air vents help to eliminate moisture build-up.

ADCO CAMPER COVERS

Fits Camper Trailers up to 86" (2.18m) wide and 54" (1.37m) high.



| Part Number | Description |
|------------------|--------------------------|
| 400-06500 | 10' - 12' (3.06 - 3.67m) |
| 400-06502 | 12' - 14' (3.67 - 4.28m) |
| 400-06504 | 14' - 16' (4.28 - 4.90m) |

ADCO CARAVAN COVERS

Fits Caravans up to 104" (2.64m) wide and 93" (2.36m) tall.



| Part Number | Description |
|------------------|--------------------------|
| 400-06510 | 14' - 16' (4.28 - 4.90m) |
| 400-06512 | 16' - 18' (4.90 - 5.51m) |
| 400-06514 | 18' - 20' (5.51 - 6.12m) |
| 400-06516 | 20' - 22' (6.12 - 6.73m) |
| 400-06518 | 22' - 24' (6.73 - 7.34m) |
| 400-06520 | 24' - 26' (7.34 - 7.92m) |

ADCO POP TOP COVERS

Fits Pop Tops up to 101" (2.57m) wide and 71" (1.80m) high

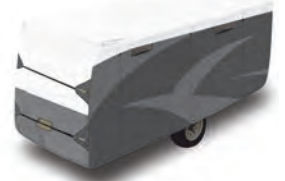

| Part Number | Description |
|------------------|--------------------------|
| 400-06522 | 12 - 14' (3.67 - 4.28m) |
| 400-06524 | 14' - 16' (4.28 - 4.90m) |
| 400-06526 | 16' - 18' (4.90 - 5.51m) |
| 400-06528 | 18' - 20' (5.51 - 6.12m) |

ADCO MOTORHOMES COVERS

Fits Motorhomes up to 104" (2.64m) wide and 93" (2.36m) tall



| Part Number | Description |
|------------------|--------------------------|
| 400-06530 | 20 - 23' (6.12 - 7.01m) |
| 400-06532 | 23' - 26' (7.01 - 7.92m) |
| 400-06534 | 26' - 29' (7.92 - 8.84m) |

ALL CLIMATE | WATER RESISTANT | 4 LAYER | HIGHLY BREATHABLE

1) Highly Protective 4 Layer Olefin HD™ Roof Panel

- Proprietary fabric has outperformed other leading roof materials
- Maximum protection against damaging UV rays
- Water resistant yet breathable
- Beads water on contact

5) Air Vents

- Help to eliminate moisture build-up
(Excludes Camper Trailer)

7) Door Flaps Double As Sun Awning

(Excludes Camper Trailer)

2) Dual Front & Rear Cinching System

- Removes slack and removes billowing

3) All Corners Reinforced

- Protects against tears caused by sharp edges

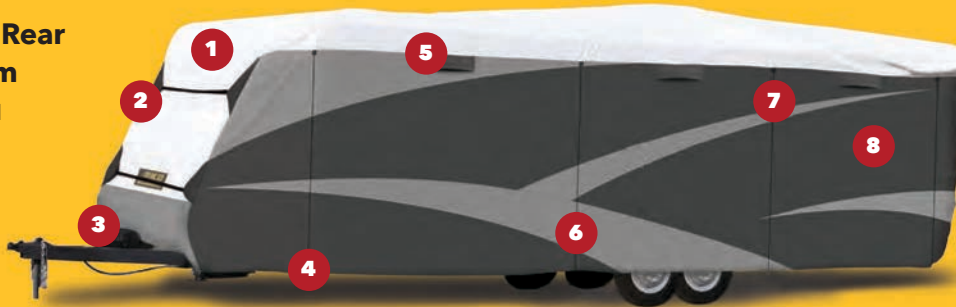

8) Polypropylene Side Panels

- Breathable & durable
4 layers

4) Eyelets In Hem

- Easily convert entry doors into a sun awning
(Excludes Camper Trailer)

6) Passenger-Side Zippered Entry Panels

- Easy access during storage
(Excludes Camper Trailer)



POP TOP, CAMPER TRAILER, CARAVAN, OR CLASS C MOTORHOME



Front and Rear Cinching System

Removes slack and reduces billowing



Olefin HD™ Roof Panel

Effectively blocks 99.8% of the sun's damaging UV rays and beads water on contact

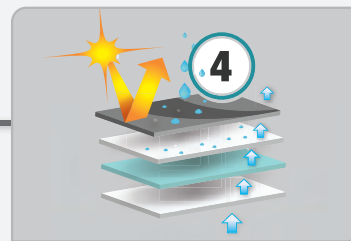

Four Layer Top & Sides

Allows cover to breathe while resisting moisture



Passenger-Side Zipper Entry Doors

for easy covered access, regardless of door position
(Excludes Camper Trailer)



Air Vents

Help the cover to breathe and prevent mould and mildew
(Excludes Camper Trailer)

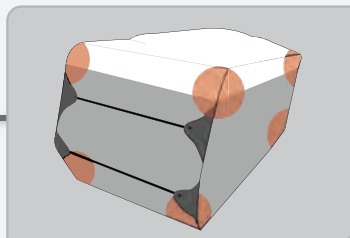

Extra Reinforcements

On all four top & bottom corners help protect against sharp edges & reduces wear



Weighted Buckle Toss-Under

Allows you to easily toss the installation straps under your RV to connect to the opposite side



Storage Bag Included

Easily store your cover when it is not in use



SUN



RAIN



SNOW

OLEFIN HD™

Superior UV stability effectively blocks 99.8% of the sun's damaging UV rays that can fade interior & exterior surfaces

ADCO ULTRA TYRE GUARDS

- > Protect your vehicle's tyres from blowouts
- > Durable heavy-duty flannel backed vinyl repels liquid and saves tyres from the sun's damaging UV rays and other environmental hazards
- > Overlapping seams, double needle stitching and reinforced grommets
- > Eliminate premature cracking of sidewalls
- > Bungee-ball fastening system eliminates loss to wind
- > Two Tyre Guards per box

400-06200

**ADCO TYRE GUARD
WHITE 30"- 32"**

400-06202

**ADCO TYRE GUARD
WHITE 27"- 29"**



ADCO TYRE COVER DIAMOND PLATE

- > Protects spare tyres from damage caused by UV rays and other elements
- > Prevents rubber from damage and cracking which can cause popping and punctures
- > Super heavy-duty vinyl construction
- > Designed to look and feel like diamond plated steel
- > Elasticized rear seam for a snug fit
- > Bottom drainage to prevent moisture buildup
- > UV and cold crack treatment

450-06300

**ADCO TYRE COVER
DIAMOND PLATE
29 3/4"**

450-06302

**ADCO TYRE COVER
DIAMOND PLATE 27"**

450-06304

**ADCO TYRE COVER
DIAMOND PLATE
25 1/2"**



PREMIER ONE CLEANING PRODUCTS

If you've ever found giving your RV a good clean bit of a mission, Premier One have come up with a great, practical idea! Telescopic, industrial strength poles that have a screw-end to attach a brush head. The brush head has super soft, non-abrasive fibres on it... so you don't have to worry about scratching the paint work on your RV.

There are two types of telescopic options available:

- > A non-flow through pole, with a comfortable safety grip
- > A flow through pole, with a comfortable safety grip.

This one is particularly useful because you can attach hose to it, allowing water to flow through the pole and onto the brush head. There is also an "on/ off" switch at the end of the pole so that you're able to minimise water wastage.

These poles and brushes are great for use on your RV or around the home, cleaning those hard to reach windows is now a breeze. Also great for the marine, transport and manufacturing industries.



400-05100

**PREMIER ONE QUAD
BRUSH HEAD**



400-05110

**PREMIER ONE BI-LEVEL
BRUSH HEAD**

Two-sided, contoured brush head. Soft bristles that are safe to use on all vehicles and designed to get into difficult spots.



400-05200

PREMIER ONE NON FLOW POLE

Made from lightweight aluminium, the non-flow through pole extends up to 2.5m



400-05300

PREMIER ONE FLOW THROUGH POLE

Made from lightweight aluminium, the flow-through pole extends up to 2.5m It also has an on/off feature built into the handle to limit water wastage.



400-05340

PREMIER ONE CARAVAN WASH 5L BOTTLE

Premium caravan wash, works in conjunction with the Premier One Foam Gun. This high foaming, PH neutral and environmentally formula is perfect for any dirty RV.



OUTBACK'S RV SUPER WASH

This product has been specially formulated to dissolve iron ore and red dirt quickly and efficiently without using dangerous chemicals or damaging the sensitive surfaces on your RV or Caravan. It is made with an acid-free, environmentally sustainable solution that can be used safely on a wide range of surfaces from painted to plastic to aluminium.

RV Super Wash is a highly versatile product that can be used on any surface of your Vehicle making it the ideal solution for the keen travellers making their way across the expansive landscape.

400-05360

OUTBACK'S RV SUPER WASH - 750ML



400-05362

OUTBACK'S RV SUPER WASH - 5L



TRAIL-A-MATE

450-00060

TRAIL A MATE HYDRAULIC JOCKEY WHEEL AND JACK KIT

Specifically designed for use with a caravan chassis, the Trail A Mate provides a unique way of making the hitching and unhitching of your caravan or camper trailer very easy (no matter how low your caravan or camper trailer might be). By removing the pin, the wheel can be replaced by the base plate and an adjustable clamp, thus turning the jockey wheel into a jack.

The kit includes: hydraulic jack on shaft, lifting clamp, jockey wheel, base plate with pin, lifting handle, bracket and bars, and a comprehensive instruction guide.



450-00085

TRAIL A MATE MARK II HYDRAULIC JACK ONLY

A heavy duty jack designed for lifting large caravans, boats and trailers. It comes with a base that enables the Mark II to be used not only as a lifting device but also as a jack stand. Manufactured to Australian and New Zealand standard 2693/2007, it has a lift capacity of up to 35cm.

SPECIFICATIONS

Working Load Limit: 1500kg
Aggregated Trailer Mass: 3500kg

* Does not include A-Frame Clamp



450-00087 TRAIL-A-MATE JACK COVER

Keep your Trail-A-Mate jacks in the best possible condition with the Trail-A-Mate Jack Cover. The cover ensures thorough protection all year round from the harsh Australian elements. Made from heavy duty all-weather material, the high-quality construction is made to last.



450-00089 TRAIL A MATE 60MM CLAMP FOR MARK II HYDRAULIC JACK

An optional clamp to enable you to use the Mark II Hydraulic Jack as a jockey wheel instead of having it permanently fixed to your RVs frame.



450-00940 TRAIL-A-MATE JOCKEY WHEEL CLAMP ANTI-THEFT LOCK

Brand new, easy to install anti-theft lock by Trail-A-Mate. Designed to secure their popular Hydraulic Trailer Jacks. This anti-theft device protects your expensive jockey wheels such as Trail-a-Mate or any jockey wheel from being stolen, features:

- > Converts a standard jockey wheel clamp into a lockable clamp
- > Fits in minutes
- > Comes complete with dust cap



450-00102 COAST JACK PADS (80MM)

Made with a durable plastic construction, Coast's Jack Pads are easy to attach. They have a universal fit & a unique channel that prevents ants from crawling up the stabilizer legs. Comes in a set of 4 & includes 4 anti-rattle sleeves.



SPECIFICATIONS

Dimensions: 158L x 138W x 74H (mm)

450-00118 STABILISER JACK PADS

Prevent your jacks or awning legs from sinking into grass or sand. Interlocking for convenient storage with a handy velcro strap. Built in handle for ease of use. Solidly constructed of a durable polypropylene with UV filters & comes in a set of 4.



JACK LEVELLING BASES

450-00120 ALKO BIG FOOT CARAVAN JACK

Alko Big Foot Caravan Jack Steady "Foot" - Anti sinking bases for the bottom of jack legs, comes in a set of 4. 1.0: 80mm



450-00121 ALKO SINGLE FOOT PIECE

Single Foot Piece to Suit Alko Big Foot Caravan Jack Steady.



450-00127 FIAMMA PLATES PRO (GREY)

A set of four anti-sinking bases with four plastic pins to fasten to the RVs drop down legs. They can be a permanent fit if required, simply leave the pin in place.



450-00132 FIAMMA PLASTIC STAKKA JACKS (GREY)

Made from UV-resistant plastic, these grey plastic jacks have an adjustable height (from 31 - 44 cm). Comes in a set of four jacks, each weighing 0.8kg. Each jack has a max load of 750kg.

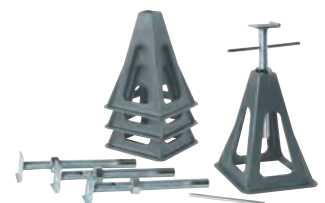

450-00152 RUBBER JOCKEY WHEEL RECEIVER

Acts as a chock for your jockey wheel. Has raised edges to ensure your jockey wheel does not roll once it is in the stationary position.



450-00160 ALUMINIUM STABILISING TRAILER JACK

Features a heavy duty non-corroding, cast aluminium base with steel screw assembly & a permanent handle. Each jack has a weight capacity of 2721kg. Comes in a set of 4.



CAMCO WHEEL CHOCKS

Solidly constructed of durable hard plastic with UV inhibitors, these yellow chocks are ideal for caravans & motor homes. They are sold separately & are available in two sizes.

450-00210 WHEEL CHOCK

Suitable for wheel diameters of up to 26" (66cm).



450-00220 SUPER WHEEL CHOCK

Suitable for wheel diameters of up to 29" (74cm).



450-00232 CAMCO TRAILER AID PLUS

Trailer-Aid is the fast, safe and easy way to change a trailer's flat tyre. Made from lightweight super strong polymer, Trailer-Aid is easy to travel with and makes changing your trailer tyre simple, even if you're alone. Trailer-Aid Plus is designed specifically for recreational trailers and gives an additional 1 inch lift. The extra 1 inch lift makes Trailer-Aid Plus handy when performing maintenance on brakes, wheels, and axles.



SPECIFICATIONS

Dimensions: 610L x 140W x 139.7H (mm)
Holds up to 6,800kg.

FIAMMA LEVEL SYSTEMS

450-00260 MAGNUM LEVELS

Lightweight blocks to level your RV that won't crack like wood. It has a self-locking overlapping system & has a max axle weight of 8t. Comes in a set of 2.

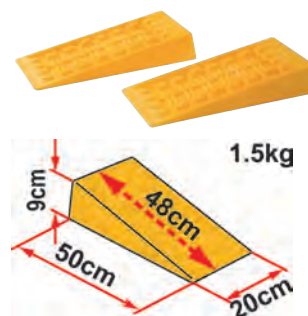

450-00262 JUMBO LEVELS

Ideal for RV's with twin tyres, the jumbo system also has the overlapping feature & has a max axle weight of 14t. Comes in a set of 2.

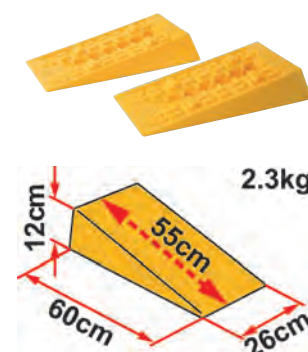

450-00273 FIAMMA LEVEL BAG

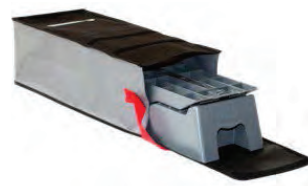

SPECIFICATIONS

Dimensions: 185 x 245 x 650 (mm)

450-00274 LEVEL PRO

Now available in grey, the Level Pro is great for caravans or trailers with small wheels (up to 145mm tread width). Made from HDPE that is also UV-resistant, they have a max axle weight of 5t. They can also be stacked on top of each other if the need for extra height arises. Comes in a set of 2.

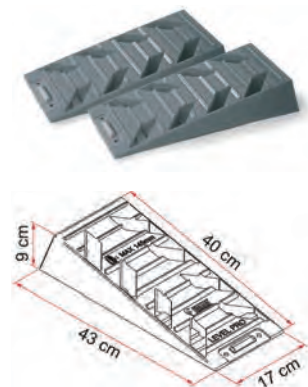

SPECIFICATIONS

Weight: 0.8kg each

450-00276

LEVEL-UP RAMPS

Fiamma's bestselling ramps are now available in grey. They are still lightweight, strong and anticorrosive, making these the best levelling choice for your RV. The Level Up has 3 levels with a ridged surface to grip the tyres in place. They have a max axle weight of 5t and come in a set of 2.

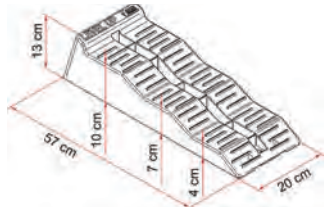

SPECIFICATIONS

Weight: 1.45kg each

450-00278

ANTI-SLIP PLATE

Now available in grey, these anti-slip plates lock onto a Fiamma ramp to provide extra grip for your RV tyres. It is especially handy on paved surfaces. Weighs just 100g and is available as a set of 2.



SPECIFICATIONS

Dimensions: 100W x 160L (mm)

450-00279

FIAMMA CHOCKS FOR FIAMMA LEVELS (GREY)

Sold in pairs, chocks are used with Level Ups, Level Pros or Level Magnums to secure the wheels during long stopovers. They come with steel hooks and are solidly made from UV-resistant polyethylene.

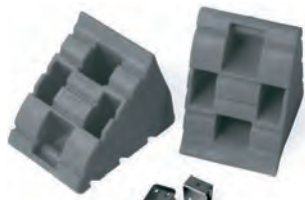

450-00280

FIAMMA LEVEL BAG S

A smaller version of the Level Bag (part number 450-00273), the Level Bag S is suitable for use with Level Pros and Level Magnums.



SPECIFICATIONS

Dimensions: 150H x 220W x 570L (mm)

450-00304

CURVED LEVELER AND WHEEL CHOCK

- > Easy drive-on leveller adds up to 4" (101mm) in height
- > Honeycomb design makes leveller lightweight but durable
- > Included chock has non-slip rubber grippers on the bottom
- > Compact length makes leveller compatible with tandem wheel spacing without modification



EXPLORE LEVELLING SYSTEM

450-00396

EXPLORE CVL2 LEVELLING RAMP (PAIR)

Made in Australia and specifically designed for tandem axle trailers, these levellers have a 5 tonne capacity. Super strong, they're able to raise a wheel up to 100mm (without the use of a jockey wheel)! They feature an extra wide tread to cater for tyre widths of up to 250mm and are lightweight at just 1.8kg each.



SPECIFICATIONS

Dimensions: 140H x 570L x 250W (mm)

450-00398

WHEEL CHOCKS TO SUIT CVL2 LEVELLING RAMPS



450-00399

STORAGE BAGS FOR CVL2 LEVELLING RAMPS

Designed specifically for the CVL2 range, the storage bag is made from tough polyester with a PVC backing. Each bag will fit a set of CVL2 levellers and a set of wheel chocks.



COAST RED LEVELLERS



Essential for all Caravanners, Coast's range of RV levelling solutions, highly visible they are made from UV resistant polypropylene to withstand prolonged outdoor use.

450-00460

COAST RED STD SINGLE WHEEL LEVEL & CHOCK KIT

Each kit comes with 1 x wheel ramp with grip spikes, 1 x chock to suit and 1 x anti-slip plate. Comes with a carry bag.



- > Highly Visible
- > Rated to 2 ton
- > Includes handy storage bag
- > Level ramp has a solid base with anti-slip spikes which means that it will not sink into soft ground
- > Anti-Slip plate clips onto the leading edge of the level ramp
- > Manufactured from tough UV resistant polypropylene plastic for superior strength
- > Kit includes level, chock and anti-slip plate, with bonus storage bag
- > Two ramps can link together side by side. Ideal for Dual Axle Motorhomes

SPECIFICATIONS

Level ramp dimensions: 520mm (l) x 200mm (w) x 125mm (h)
Chock dimension: 150mm (l) x 120mm (w) x 100mm (h)

450-00462

COAST RED SINGLE MULTI LEVEL RAMP

Each pack contains:
x1 Tri-Level Wheel Ramp



- > High visibility
- > Each level has three different heights
- > Rated to 2 ton
- > Includes a handy storage bag
- > Made from UV-resistant polypropylene
- > Helps to level caravans or motorhomes on uneven ground
- > Lightweight
- > 3 height levels 4, 7 & 10 cm
- > Anti-slip surface for extra grip
- > Suitable for vehicles up to 2 ton

SPECIFICATIONS

Level ramp dimensions: 610mm (l) x 210mm (w) x 120mm (h)

450-00464

COAST RED STD SINGLE WHEEL CHOCK

Suitable for use with the standard wheel ramp part number 450-00460. These are sold singularly.

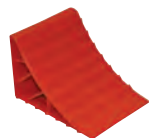

SPECIFICATIONS

Chock dimensions: 150mm (l) x 120mm (w) x 100mm (h)

450-00466

COAST RED TYRE SAVERS 2-PACK

- > Prevents flat spots on your tyres
- > Suitable for tyres with diameters from 10" to 20"
- > Works with most types of security wheel clamp
- > Suitable as a "Stop" by bolting to garage floor
- > Suitable for use with caravans, trailers & any vehicle that is stationary for long periods
- > Two ramps can link together side by side. Ideal for Dual Axle Motorhomes

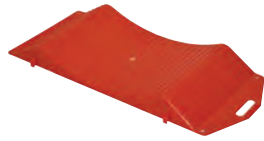

SPECIFICATIONS

Tyre Saver dimension: 440mm (l) x 200mm (w) x 40mm (h)

COAST RED TREAD AND STORE

450-00490

COAST RED TREAD AND STORE - FOLDING COMBINATION RECOVERY BOARDS & STORAGE BOX

- > Set of folding vehicle recovery boards
- > Provides traction if stuck in sand, mud or snow
- > Doubles as a heavy-duty storage box
- > Hinged lid for easy access to stored content



COAST JOCKEY WHEELS

Coast to Coast's range of quality jockey wheels is now available. Perfectly suited for most caravan, trailer and horse float applications, this new range has all of your jockey wheel needs sorted.

The range features three jockey wheel size variants from 6" to 10". The smaller wheels are ideal for use on paved and hard surfaces while the 10" wheels allow for even soft ground surfaces to be navigated safely. Each jockey wheel size is available with the choice of standard or swivel clamp. The swivel clamp allows the jockey wheel to be quickly and conveniently rotated out of the way when your hitched up and ready to hit the road.

Coast Jockey Wheels come individually packaged in shipping cartons while additional standard clamps are available in retail packaging. Don't miss out, stock up on these exceptional value Jockey Wheels today.

450-10000

COAST 6" JOCKEY WHEEL + STD CLAMP

SPECIFICATIONS

Capacity: 340kg
Lifting height(mm): 254
N.W: 4.5kg



450-10002

COAST 6" JOCKEY WHEEL + SWIVEL CLAMP

SPECIFICATIONS

Capacity: 340kg
Lifting height(mm): 254
N.W: 6kg



450-10004

COAST 8" JOCKEY WHEEL + STD CLAMP

SPECIFICATIONS

Capacity: 340kg
Lifting height(mm): 254
N.W: 6.3kg



450-10006

COAST 8" JOCKEY WHEEL + SWIVEL CLAMP

SPECIFICATIONS

Capacity: 340kg
Lifting height(mm): 254
N.W: 7.5kg



450-10008

COAST 10" PNEUMATIC JOCKEY WHEEL + STD CLAMP

SPECIFICATIONS

Capacity: 340kg
Lifting height(mm): 254
N.W: 6.2kg



450-10010

COAST 10" PNEUMATIC JOCKEY WHEEL + SWIVEL CLAMP

SPECIFICATIONS

Capacity: 340kg
Lifting height(mm): 254
N.W: 7.5kg



450-10020
COAST STD JOCKEY
WHEEL CLAMP
(50MM/750LBS)



ALKO JOCKEY WHEELS

450-00600
ALKO 6" JOCKEY WHEEL
 Has a standard clamp with a solid rubber tyre (150D x 50W mm).



450-00610
ALKO 6" JOCKEY WHEEL
 Has a locking pin swivel bracket with a rubber tyre (150D x 50W mm).



450-00620
ALKO 8" JOCKEY WHEEL
 Has a standard clamp with a rubber tyre (200mm diameter) & steel rim.



450-00632
ALKO 10" JOCKEY WHEEL
 Has a standard clamp with a solid tyre (250mm diameter), suitable for softer ground thanks to the larger wheel diameter.



450-00642
ALKO 10" JOCKEY WHEEL
 has a large locking pin swivel bracket with a solid tyre (250mm diameter).



450-00644
ALKO THRUST BEARING
 Used on 6", 8" and 10" Alko jockey wheels and power mover.



450-00646
ALKO JOCKEY WHEEL HANDLE
 Suitable for pin-type handles.



450-00660
ALKO POWER MOVER
 Has a ratchet mechanism for added convenience & a solid tyre (250mm diameter).



450-00684
ALKO 6" SOLID RUBBER WHEEL



450-00686
ALKO 8" SOLID TYRE WHEEL



JOCKEY WHEELS

450-00698

SOLID RUBBER TWIN JOCKEY WHEEL (WITH CLAMP)

Perfect for using in combination with your caravan or trailer mover and is suitable for use with single axle and dual axle trailers. The benefit of using the Twin Jockey Wheel is that it does not dig in or jam up on surfaces like some single jockey wheels. It greatly improves the operation on a single and dual axle caravan/ trailer mover regardless of the caravan/ trailer weight. The Twin Jockey Wheel has a heavy duty clamp and the wheels are 10" solid rubber. The tyre has a steel centre with a bronze bush bore while the jockey wheel itself is zinc plated to deter rust.



SPECIFICATIONS

Weight: 17kg
Lift Capacity: 225mm
Static Load Capacity: 1000kg

JOCKEY WHEEL CLAMPS

450-00669

ALKO PREMIUM WIDE CLAMP



450-00700

STANDARD BOLT ON CLAMP

(no swivel function) to suit jockey wheel.



450-00702

ADJUSTABLE SWIVEL JOCKEY WHEEL BRACKET

Has a locking pin swivel function (150H x 210W mm).

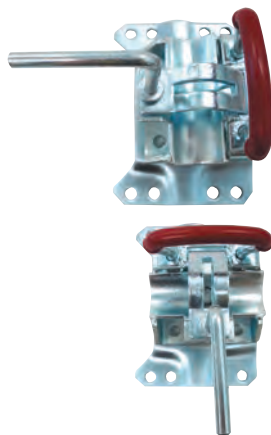

WINDER HANDLES

450-00711

SLOTTED STYLE WINDER HANDLE TO SUIT REAR JACKS

SPECIFICATIONS

Length: 700mm (including the handle)

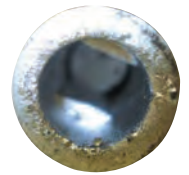

450-00712

HEX STYLE WINDER HANDLE TO SUIT CORNER JACKS

SPECIFICATIONS

Length: 800mm (including the handle)



450-00714

HEX WINDER HANDLE

SPECIFICATIONS

Length: 1150mm (including the handle)



ARK JOCKEY WHEELS

450-00720

150MM (6") STANDARD WHEEL

Has a locking swivel u-bracket & a 350kg load capacity.

SPECIFICATIONS

Maximum Extension: 250mm



450-00722

200MM (8") STEEL RIM RUBBER WHEEL

Has a locking swivel u-bracket & a 350kg load capacity.

SPECIFICATIONS

Maximum Extension: 250mm



450-00742

ARK XO SERIES JOCKEY WHEEL

Ark's new Extreme Off road Series (XO) Jockey Wheel is probably the toughest, most advanced Jockey Wheel in Australia today. But not only is it tough, it's also versatile - with multiple height options, a highly maneuverable trailing yoke design and 5 different yoke locking positions.



- > Magnetic, removable, side-winding handle
- > Heavy duty body with 750kg rating
- > 4 x adjustable height positions
- > Heavy duty swivel clamp
- > Dual wheel with sealed bearings & off road tread
- > Rust resistant finish

450-00750

6" SOLID RUBBER WHEEL TO SUIT JOCKEY WHEEL

SPECIFICATIONS

Wheel diameter: 140mm
Tread width: 40mm



450-00910

TRAILER COP ANTI-THEFT COUPLING LOCK

The ball type anti-theft trailer lock that prevents thieves from towing your trailer away by expanding in your coupler. Suitable for use on 50mm couplers, it takes just a minute to install.



450-00924

KOVIX TRAILER HEAVY DUTY PADLOCK

Built for maximum security, this unique alarmed trailer lock is the ultimate deterrent to would-be thieves.

Designed by Kovix Australia the heavy duty KTR-18 alarmed trailer lock is made from 304 grade stainless steel. Resistant to impact, drilling and cutting this ultra-strong trailer lock features an 18mm pin with an anti-cutting sleeve.



This smart lock's alarm can be turned on or off and is triggered by a motion sensor that activates the 120dB alarm for 10 seconds. The lock is rust resistant and its electronics are water proof so it can be left out in the elements. Built to suit standard 50mm ball hitches, Off Road DO35 and Treg-style block hitches, the KTR-18 is as versatile and smart as it is tough.

FEATURES

- > Anti-Impact and Drill Resistant
- > Weatherproof Electronics (IP67)
- > Removable Ball to Fit a Wide Range of Hitches - (H 100mm x W 155mm x D 35mm - Inside W 80mm)
- > Built in Loud Alarm - Sounds at 120dB
- > Long Life 3V Lithium Battery Included
- > Double Locking Pin System

450-00932

KOVIX DO35 COUPLING LOCK

Protect your caravan, camper or boat with this purpose-built lock for the DO35.

- Unique Features:
- > Fits the DO35 coupling
 - > Weather resistant
 - > Ultra-Strong. Heavy duty, 304 stainless steel construction
 - > 18mm locking pin
 - > Anti-impact, saw and drill resistant



450-00927

MILENCO SECURITY PIN LOCK T/S DO35 PIN COUPLING

- > Secures your RV
- > Complete with plastic storage case
- > Made from Heavy Duty Steel
- > Integrated high security lock
- > Fast and simple to fit
- > Compact and lightweight
- > Variable height setting



3 SECTION STEPS

MILENCO SECURITY CABLE

- > Coated braided stainless steel cable
- > Secure your valuables- Bicycles, BBQ, Portable Fridge
- > Integrated combination security lock
- > Fast and Simple to Fit
- > Compact and Lightweight design
- > Combination lock - set your own code.

450-00928
6m



450-00929
10m



450-00926 MILENCO AUSTRALIAN HITCHLOCK WITH CHAIN LOCK

- > Tough and dependable steel
- > Clamps over tow ball and secured chains
- > Complete with 3 Keys



450-00931 DUAL TRAILER COUPLING LOCK HEAVY DUTY - INC. PADLOCK

Secure your parked caravan to the towing vehicle and secure it even when its not attached to a vehicle,

Features

- > Heavy duty coupling lock
- > Works when hitched and unhitched.
- > Simple and easy to use
- > Supplied with high-quality padlock
- > Suits Australian 50mm ball couplings
- > Suitable for use with caravans, trailers and horse floats



450-01050 CAMCO FOLDING STEP

Holds up to 136kg (300lbs) & has a large non-slip surface. Folds flat for easy storage (grey).



450-01070 MGI MILENCO GIANT SINGLE STEP - 200KG RATED

Features a giant tread area that strictly meets safety guidelines to allow a safe carry load of 200kg, skid resistance, and a tread that is non-slip, even when wet. Produced using 100% recycled plastic.



SPECIFICATIONS

Tread Size: 455mm x 363mm
Height: 265mm
Weight: 1.7kg

450-01072 MGI MILENCO DOUBLE STEP - 200KG RATED

Emphasizes safety with non-slip tread and highly skid-resistant upper tread surface for maximum safety in both wet and dry conditions. Fitted with four rubber feet to prevent skidding on asphalt and peg holes for use on grass.



SPECIFICATIONS

Tread Size: 360mm x 220mm
Height: 185mm x 365mm
Weight: 2.9kg

450-01104 COAST FOLDING ALUMINUM RV STEP (220KG CAPACITY)

This folding aluminium RV Step features a light weight and sturdy design and can support up to 220kg. It has anti-slip strips and grippy rubber feet for extra stability.



SPECIFICATIONS

Folded size: 47.5 x 30 x 7cm
Open size: 47.5 x 30 x 22.5cm
Net weight: 2.2kgs

450-01106
COAST HEIGHT
ADJUSTABLE - FOLDING
ALUMINIUM RV STEP
(150KG CAPACITY)

This folding aluminium RV Step features a light weight and sturdy design and can support up to 150kg. It has anti-slip strips, grippy rubber feet for extra stability and adjustable feet that offer four height adjustments.



SPECIFICATIONS

Folded size: 48.5x36.8x7cm
 Open size: 18.5 - 19.8 - 21 - 22.5cm
 Net weight: 2.6kgs

450-01405
SINGLE PULL-OUT
CARAVAN STEP

SPECIFICATIONS

Step Width: 514mm
 Tread Depth: 180mm
 Closed Dimensions: 300D x 530W x 180H (mm)
 Mounting plate to top of step: 145mm



450-01415
DOUBLE PULL-OUT
CARAVAN STEP

SPECIFICATIONS

Bottom Step Width: 520mm
 Bottom Step Tread Depth: 180mm
 Top Step Width: 510mm
 Top Step Tread Depth: 305mm
 Closed Dimensions: 380D x 590W x 310H (mm)
 Mounting plate to top of step: 180mm
 Mounting plate to the top of bottom step: 305mm



450-01422
COAST MK2 SILVER SPRING LOADED
ALUMINIUM FOLD OUT SINGLE STEP
- 588MM WIDE

This folding aluminium RV Step features a light weight and sturdy design and can support up to 150kg. It has anti-slip strips, grippy rubber feet for extra stability and adjustable feet that offer four height adjustments.

FEATURES

- > Anit skid tread
- > Spring loaded
- > Rated to 200kg
- > Step weight 4.7kg
- > Dimensions: 588mm wide overall - Tread width 552mm



450-01530
FIAMMA PLASTIC STEP
SMALL

Step in & out of your RV safely! Has a non-skid surface & is made from UV resistant HD polyethylene. Holds up to 150kg & comes in grey.

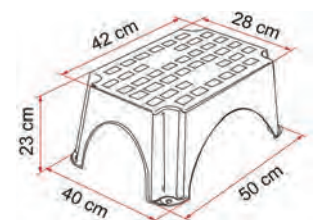

450-01552
FIAMMA MAGNUM PLASTIC
STEP

An improved version of Fiamma's best selling step. Made from UV resistant HD polyethylene for great stability & strength. Comes in grey & can hold up to 200kg.



450-01570
FIAMMA CLEAN STEP

Suitable for use on electric or manual steps, it helps to keep your RV clean. Made from durable plastic it has a grass appearance & is supplied with springs for installation. Can be adapted to fit steps from: 380 x 400mm up to 450 x 400mm. Available in green.

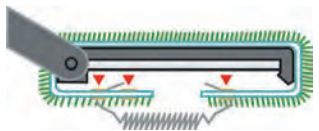

450-01990
WHEEL NUT
 Wheel nut for alloy rim



SPECIFICATIONS

Dimensions: ½" thread diameter with a 2mm pitch

3 SECTION STEPS

450-02020 COAST SPARE WHEEL CARRIER 6 STUD SILVER

Coast to Coast very own Spare Wheel Carrier to suit popular 4, 5 and 6 stud wheels. Ideal for caravans, campers, horse floats and all trailers.



FEATURES

- > Heavy duty galvanized spare wheel mount
- > Suits 4, 5, and 6 stud wheels
- > Comes ready for easy installation and simple use
- > Designed to fit 4 and 5 inch A frames.

NUOVA MAPA ELECTRIC STEPS

This series of innovative electrical steps are made from galvanised steel for durability & stability. The footrests are made with anodized aluminium (so they won't rust) & are spaced at a comfortable height for your convenience. Order separate wiring loom as required.

450-02100 12V SINGLE ELECTRIC STEP



SPECIFICATIONS

Step Width: 575mm
Step Tread Depth: 210mm
Step Weight: 7.8kg
Step to Mounting Plate: 197mm

450-02110 12V DOUBLE ELECTRIC STEP

Order separate wiring loom as required.



SPECIFICATIONS

Step Width: 575mm
Step Tread Depth: 210mm
Step Weight: 11.7kg
Bottom Step to Top Step: 200mm Top
Step to Mounting Plate: 197mm
Width from center hole to center hole on the mounting plate: 530mm

450-02120 WIRING HARNESS WITH AUTO CLOSE ON IGNITION

If you forget to close your step, on ignition of your vehicle, the step will close automatically.

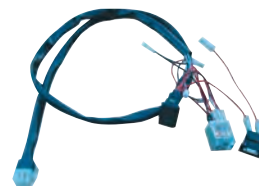

450-02130 STANDARD WIRING HARNESS WITH SWITCH

A standard in/ out switch which can be installed near the entry to engage or disengage the step.



450-02140 MANUAL SINGLE STEP

Made with the same quality and precision as the electric steps, the Manual Single Step holds up to 200kg. It requires minimal effort to open or close as it is spring loaded.



SPECIFICATIONS

Step Width: 560mm
Step Weight: 5.5kg
Step to Mounting Plate: 197mm

450-02150 SPRINGS FOR MANUAL STEP

Sold in pairs.



450-02300 RV WRAP AROUND STEP RUG (GREY)

Adjusts to fit almost any RV step. Just wrap it around your existing step & hook springs into the holes that fit your step. No screws, glues or tools needed! Helps to keep your RV clean.



WHEEL SPATS

450-01690
JAYCO STARCRAFT
SINGLE WHEEL SPAT
 White (sold singularly)



450-01692
JAYCO WESTPORT
SINGLE WHEEL SPAT
 Metallic blue (sold singularly)



450-01694
JAYCO EARLY HERITAGE
DOUBLE WHEEL SPAT
 White (sold singularly)



450-01696
JAYCO WESTPORT DOUBLE
WHEEL SPAT
 Metallic blue (sold singularly)

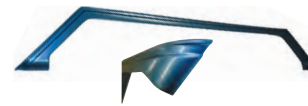

450-01698
JAYCO FREEDOM
SINGLE WHEEL SPAT
 White (sold singularly)



450-01699
JAYCO LATE MODEL
HERITAGE DOUBLE WHEEL
SPAT
 White (sold singularly)

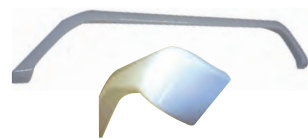

450-02498
JERRY CAN HOLDER
 Has a lockable chain.



450-02500
ADJUSTABLE JERRY CAN HOLDER
 Designed to fit many jerry can sizes & has an anti-theft adjustable locking bar.



450-02510

WELD ON JERRY CAN HOLDER
 An economical solution to jerry can storage, this metal strap type holder is zinc plated to help minimise the occurrence of rust.



SPECIFICATIONS

Dimensions: 370W x 180L x 295D (mm) Weight: 3kg

LCI LIPPERT ELEC-BRAKE HUB DRUMS

Lippert Components Brake Drum Hub Assemblies are an industry standard. Lippert Trailer hub assembly (hub and drum) provides surface area for brake shoes to grip when brakes are activated and are compatible with standard axles from most manufacturers.

LIPPERT Brake assembly plates feature a bushed oval magnet. This feature comes as standard and for good reason as the bush provides added protection against dust. In a standard magnet dust intrusion quickly builds up and provides a friction point for the magnet and causes accelerated wear.

Electric Brake Hub Drums

The hub drum is what connects the trailers wheels to the trailers axle and houses the wheel bearings. The hub drum is the part that rotates and inside this drum sits a stationary electric brake assembly plate containing the braking shoes and magnet. The Hub also provides a steel inner face for the magnet to stick onto when powered. When this happens, the shoes are activated and they expand out to grip the inner walls of the rotating drum providing friction which in-turn drastically slows down the spinning drum.

Due to the magnet dragging on the inner-face of hub-drum they wear out. They can be machined to provide a flat surface for the magnet to comfortably adhere to but eventually you will need to simply replace them. Electric Hub drums also feature bearings so they can be attached as one unit to your axle and have the wheel studs already fitted so you can easily attach them to your wheels - both bearings & wheel stud PCD's will vary depending on what they are suited for.

450-11002
LCI LIPPERT 10" ELEC-BRAKE HUB DRUM
- 6-STUD LANDCRUISER PCD



450-11004
LCI LIPPERT 12" ELEC-BRAKE HUB DRUM
- 6-STUD LANDCRUISER PCD



Electric Brake Backing Plate

The Electric Brake Backing Plate sits inside the hub drum and holds the shoes, magnet, actuator levers, connections and mechanical handbrake.

The backing plates magnet is attached to a lever which is connected to the shoes, when the magnet is electrified it sticks to the spinning hub drum which pulls the magnet in the same direction as the spinning hub.

As the magnet is attached to a lever that when pulled opens up the brake shoes to grip the spinning hub drum and slow down its momentum causing the trailer to brake. Another important function with the brake plate is the inclusion mechanical handbrake which is for when the trailer is parked, how it works is that is separate lever connected to the shoes & on the other end of this lever is a hole when you can connect the trailers park brake cable, when you activate your trailers hand brake this pulls on the lever which then opens the shoes providing your park brake.

450-11010
LCI LIPPERT COMPLETE 10" L/H ELEC-BRAKE ASSY
 Plate. 853107



450-11012
LCI LIPPERT COMPLETE 10" R/H ELEC-BRAKE ASSY
 Plate. 853108



450-11014
LCI LIPPERT COMPLETE 12" L/H ELEC-BRAKE ASSY
 Plate. 853126



450-11016
LCI LIPPERT COMPLETE 12" R/H ELEC-BRAKE ASSY
 Plate. 853127



450-03010
BRAKE MAGNET KIT
 Electric Brake Magnet Oval Type - comes in a box complete with springs, suits DEXTER 10" x 2.25" / Hayes 10" x 2.25" & 1.625" (after 1987 up to 1993)



ELECTRIC DRUM BRAKES

Electric drum brakes are an efficient & reliable braking system that provides smooth braking when used by a vehicle mounted with a brake controller.

450-03030
ALKO 10" X 2-1/4" RIGHT HAND ELECTRIC DRUM BRAKE
 With park brake provision.



450-03032
ALKO 10" X 2-1/4" LEFT HAND ELECTRIC DRUM BRAKE
 With park brake provision.



ELECTRIC HUB DRUMS

These hub drums are machined for slimline bearings. Note when replacing magnets, it is recommended that the inside face of the hub drum be re-machined or the magnet performance will be affected.

450-03034
ALKO 10" X 2-1/4" FORD 5 STUD PATTERN ELECTRIC HUB DRUM
 Machined for slimline bearings.



450-03036
ALKO 10" X 2-1/4" LANDCRUISER 6 STUD PATTERN ELECTRIC HUB DRUM
 Machined for slimline bearings.



450-03065

ALKO BOXED 10" BRAKE SHOE KIT

Used to support and move the braking lining material, this electric brake shoe kit consists of two primary and two secondary brake shoes conveniently packaged in a box.



ELECTRIC DRUMS

Brake drums are selected by the drum diameter, the wheel drilling pattern and in the case of hub drums, the machining profile and appropriate bearings. It is important to select the appropriate brake capacity and seek advice on the correct axle machining profile and bearing configuration to carry and stop the load on the wheel to which it is fitted.

450-03084

ALKO 10" X 2-1/4" LANDCRUISER PARALLEL ELECTRICAL BRAKE DRUM



BEARING KITS

Bearings comprise of two parts, the cup which is pressed into the hub & the cone, this is the part that contains the rollers of the bearing. Bearings should always be replaced in pairs.

450-03069

ALKO PARALLEL BEARING KIT

A Japanese caravan bearing kit, rated to 1600kg per pair. Always ensure that only quality studs and nuts are used, which are correct for the wheel selected. Comes in a skin pack.



450-03086

ALKO 10" X 2-1/4" HOLDEN HT SLIMLINE ELECTRICAL BRAKE DRUM



450-03088

ALKO 10" X 2-1/4" HOLDEN HQ LM SLIMLINE ELECTRICAL BRAKE DRUM



450-03070

ALKO SLIMLINE/FORD CARAVAN BEARING KIT (JAPANESE)

Slimline Components Include

1x L68110 cup, 1x LM12710 cup, 1x L68149 & 1x LM12749 cone.



ARK BEARING KITS

450-03100

MARINE BEARING KIT TO SUIT HOLDEN TYPE BEARINGS

4 Piece Blister Pack



450-03072

ALKO LM/HOLDEN TRAILER BEARING KIT (JAPANESE)

LM Components Include

1x LM67010 cup, 1x LM11910 cup, 1x LM67048 cone, 1x LM11949 cone, 1x grease cap, 1x seal & 1x split pin



450-03102

MARINE BEARING KIT TO SUIT FORD TYPE BEARINGS

4 Piece Blister Pack



450-03110

TRAILER BEARING KIT TO SUIT HOLDEN TYPE BEARINGS

5 Piece Blister Pack



450-03112

TRAILER BEARING KIT TO SUIT FORD TYPE BEARINGS

5 Piece Blister Pack



BEARING CONES

450-03128

BEARING TO SUIT HOLDEN 1-1/4" CONE

For 39mm round or 40mm square axles.



450-03130

BEARING TO SUIT FORD (SLIM LINE) 1-3/8" CONE

For 45mm square axles.



450-03132

BEARING TO SUIT HOLDEN 3/4" CONE

For 39mm round or 40mm square trailer axles.



450-03134

BEARING TO SUIT FORD (SLIM LINE) 7/8" CONE

For 45mm square trailer axles.



COAST SEALS

Coast's range of seals are available in two grades. Standard includes a spring under the inner lip that seals against the axle. Premium heavy duty includes a firmer better-quality firmer spring providing a more durable seal in the long run.

Coast's range of bearings and seals allows for servicing of the following:

- > Holden/LM type trailer axles up to 1000kg in both standard and marine seals
- > Ford/Slimline type trailer and caravan axles up to 1450kg in both standard and marine seals
- > 1.5tonne/Composite caravan axles up to 1500kg with standard seals
- > Parallel caravan axles up to 1600kg with standard seals
- > 2 tonne and 2.5 tonne caravan axles up to 2500kg with standard seals

450-03200

COAST HUB BEARING STD OIL SEAL - HOLDEN

Sold by 10 pk



450-03202

COAST HUB BEARING PREMIUM H-DUTY OIL SEAL - HOLDEN

Sold by 10 pk



450-03206

COAST HUB BEARING PREMIUM MARINE OIL SEAL - HOLDEN

Sold by 10 pk



450-03208

COAST HUB BEARING STD OIL SEAL - FORD/SLIMLINE

Sold by 10 pk



450-03210

COAST HUB BEARING PREMIUM H-DUTY OIL SEAL - FORD/SLIMLINE

Sold by 10 pk



450-03212
COAST HUB BEARING PREMIUM MARINE OIL SEAL - FORD/SLIMLINE
 Sold by 10 pk



450-03214
COAST HUB BEARING OIL SEAL - 1.5 TONNE
 Sold by 10 pk



450-03216
COAST HUB BEARING OIL SEAL - 2/2.5 TONNE
 Sold by 10 pk



450-03220
COAST STD HUB REPLACEMENT GREASE CAP T/S HOLDEN-FORD 45.2MM DC-1
 Sold by 10 pk



450-03222
COAST HUB REPLACEMENT GREASE CAP T/S PARALLEL/1.5/2/2.5 TONNE. 63 MM DC-2
 Sold by 10 pk



NSK JAPANESE BEARINGS

These high-quality Japanese bearings use conical rollers guided by a back-face rib on the cone and are capable of taking high radial loads and axial loads in one direction. They are ideal for use in servicing and repairing trailers and RVs.

450-03230
NSK JAPANESE BEARING - HOLDEN/LM INNER



450-03232
NSK JAPANESE BEARING - HOLDEN/LM OUTER



450-03234
NSK JAPANESE BEARING - FORD/SLIMLINE INNER



450-03236
NSK JAPANESE BEARING - FORD/SLIMLINE OUTER



450-03238
NSK JAPANESE BEARING - 2 TONNE INNER



450-03240
NSK JAPANESE BEARING - 2 TONNE OUTER



450-03504

TREG T BAR PIN AND LOCK

- > Locks the trailer to the vehicle or locks the trailer when un-hitched.
- > Hardened 3/4" steel pin
- > Zinc plated for corrosion protection
- > Precision Zinc alloy screw pin lock with 1/4" pin and 2 keys.



450-04010

2-WAY PLASTIC TEE BUBBLE LEVEL

Screw-mounted level, providing front to back or side to side levelling. Sold separately.



450-03506

TOW BALL SPANNER

- > Tow Ball Sizes 33mm
- > Adj. Ball Mount Bolts 24mm
- > WDH Head Bolts
- > WDH Chain Bracket Bolts
- > D Shackle Pins



450-04030

BULLSEYE MULTI-DIRECTIONAL LEVEL

Round, dome-shaped level reads 360o at once.



450-03520

COUPLE - MATE REVERSING HITCH AID

An easy to install device which makes hitching your caravan or trailer a breeze. The side arms 'guide' the trailer hitch towards the tow ball, thus preventing damage to the tow vehicle. Made from double dipped, zinc plated steel.



450-04032

CAMCO CURVED BALL LEVEL

A screw-mounted level, with graduated markings for accurate front-to-back or side-to-side levelling. Comes in a set of 2.



450-03530

COUPLE-MATE TREG PIN LOCK

Featuring a latch lock with a screw lock for added security, the treg pin lock is used to lock the trailer onto your tow vehicle, or simply lock the trailer when left unattended. It has a 3/4" diameter for use with treg couplings. Note that the lock mechanism needs lubricant periodically to ensure correct operation.



450-04006

SCREW ON LEVEL

Screw-mounted level provides front-to-back or side-to-side levelling. Comes in a set of 2.



450-04810

HEAVY DUTY BOLT ON JOCKEY WHEEL DOUBLE CLAMP

Heavy Duty Bolt on DOUBLE Clamp offers superior clamping force over other clamps available in the market. The Universal backing plate allows for easy fitment on 4", 5" or 6" chassis", no need for drilling or welding. Comes complete with bolts.



450-04996

CRUISEMASTER 3500KG DO35 V3-PLUS COUPLING - INCLUDES TOW-PIN & H/ BRAKE.

FOR SAFETY ON ROAD AND CAPABILITY OFF IT

High articulation in all direction ensures the trailer always follows you in challenging terrains. High articulation also provides safety in the event of an accident on the road.



ARK XO EXTREME OFF ROAD COUPLING

Quick-hitch off road coupling. Suits all 50mm tow balls that comply with Australian Standards AS4177.2 except 50mm tow balls with a flat flange. No more switching hitches!

Choice of 2 ratings

- > 2 tonne for mechanical over-ride brake systems. Part No. 450-04900
- > 3.5 tonne for electric brake systems. Part No. ORXOF50 450-04902
- > Full off road articulation
- > No more switching hitches
- > Quick-hitch locking system
- > Fits 50mm tow balls that comply with Australian Standards AS4177.2 and don't have a flat flange
- > Complies to Australian standards AS4177.3
- > Strong fully cast steel parts

Whether you are looking to improve your off road capability, or just tired of constantly having to switch between an off road hitch and a standard ball hitch, then the Ark Extreme off road Coupling is for you!

450-04900

ARK XO EXTREME OFF ROAD COUPLING 2 TONNE



450-04902

ARK XO EXTREME OFF ROAD COUPLING 3.5 TONNE



SIMPLE TO USE LOCKING MECHANISM

The DO35 features a simple positive locking mechanism. Once locked the Check lock cap is then fitted to keep the dirt out and to show that the coupling is securely attached.

PATENTED DROP ON DESIGN ALLOWS EASY HITCH IN ANY TERRAIN

This is the key to the success of the DO35. Combined our patented tow pin and view port, allows easy alignment of the vehicle and trailer even in technical terrain.

ARTICULATION: 360 degrees axial, minimum 70 degrees other axes.

LOCKING: Fully ADR 62/02 compliant including automatic secondary lock

FINISH: Supa Alloy 5

BOLT PATTERN: 4 bolts at 185mm x 54mm

RATING: 3.5 Tonne

ACTION: Drop-On

MAINTENANCE: Fully Greasable

NEW FEATURES: New polyurethane bushed Tow Pin, Dustcap & Bumpstop. New Integrated Handbrake lever

3 SECTION SHACKLES

SHACKLES

"The current standard applying to shackles is AS 2741-2002, however this standard does not specifically cover the use of rated shackles in an application such as attaching a trailer to a tow bar. This standard covers the use of shackles for lifting purposes.

The Caravan Industry Association of Australia's recommendation is that a shackle meeting the requirements of AS 2741-2002 be used to secure rated safety chains up to 3500kg capacity.

Suitable shackles have the following specifications:

- > Meet the requirements of AS 2741-2002
- > Shackle grade is "S" or "6"
- > Working load limit (WLL) is 1000kg
- > Shackle diameter is 10mm
- > Either "bow" or "dee" shackle design is suitable, although it is noted that the "bow" design provides greater angular displacement

A significant detail to understand is that the breaking load of a shackle is generally six times the working load limit."

Source: RVMAP Technical Alert - D-Shackle Confusion Resolved, 20.10.2014

450-05000
DEE SHACKLE GALVANISED - 8MM
(5/16)

Not to be used with safety chains as this is a general purpose shackle.



450-05002
DEE SHACKLE GALVANISED - 8MM
(5/16)
RATED TO 0.75T



450-05010
DEE SHACKLE GALVANISED - 10MM
(3/8)

With a working load rating of 320kg and a proof load rating of 640kg. Not to be used with safety chains as this is a general purpose shackle.



450-05012
DEE SHACKLE GALVANISED - 10MM
(3/8"), RATED TO 1T



450-05020
DEE SHACKLE GALVANISED
- 12MM (3/8")

Dee Shackle Galvanised - 12mm with a working load rating of 520Kg and a proof load rating of 1040Kg. Not to be used with safety chains as this is a general purpose shackle.



450-05022
DEE SHACKLE GALVANISED
- 11MM (7/16"), RATED TO 1.5T



450-05024
DEE SHACKLE GALVANISED
- 13MM (1/2"), RATED TO 2T



HAND BRAKE SPARES

450-05050
HAND BRAKE WIRE CABLE
4mm x 10m length



450-05060
HAND BRAKE CABLE
ADJUSTER
(With Pulley)



450-05070
HAND BRAKE CABLE CLIPS



450-05080
BRAKE CABLE
PULLEY



ALKO COUPLINGS

450-05110 2000KG 2-HOLE SNAP ON COUPLING WITH BALL ADJUSTER

Mounting Hole: 101.6L x 13.5W (mm)
zinc plated surface, ball to first
centre.
Hole: 77mm



450-05120 3500KG ELECTRIC COUPLING WITH HAND BRAKE

A zinc plated coupling that is
simple to attach to the tow
ball.



SPECIFICATIONS

Mounting Hole: 182.5L x 55W (mm)
Diameter: 13.5mm

450-05130 2000KG MECHANICAL OVERRIDE COUPLING (NO PLATE)

A zinc plated coupling that is
suited to 50mm ball types.



SPECIFICATIONS

Mounting Hole: 184L x 54W x 13.5 Diameter (mm)
Ball to first centre hole: 137mm

450-05140 BRAKE PLATE FOR MECHANICAL OVERRIDE COUPLING

Has a painted surface.

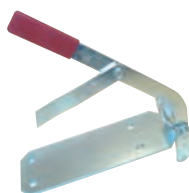

SPECIFICATIONS

Mounting Hole: 184L x 54W x 13.5 Diameter (mm)

450-05146 ALKO AKS TOW BALL RETENTION PLATE

AKS anti-rotation 50mm tow
ball plate for lug type tow bar
75mm wide.



450-05147

ALKO AKS HIGH RISE 50MM TOW BALL

AKS anti-rotation 50mm high rise tow ball (black)



450-05150 HYDRAULIC CONVERSION WITH 3/4" MASTER CYLINDER

Converts mechanical couplings to
hydraulic couplings (a more reliable
braking system), suited for vehicles
with a hydraulic drum/brake set up, zinc
plated.



ALKO CORNER STEADIES

Corner steadies are not designed to be used as a jack or
as the method of lifting the trailer off the ground. They are
designed to stabilize the trailer or caravan when stationary.

450-05300 500MM CORNER STEADY

Has a front hex drive & is
zinc plated.

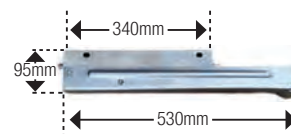

450-05302 500MM CORNER HEX DRIVE

(Bolt On)

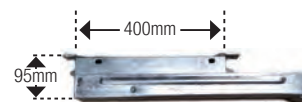

450-05310 600MM CORNER STEADY

Has a front hex drive & is
zinc plated.

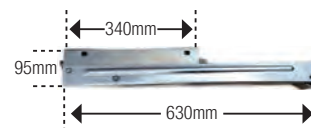

450-05320 700MM CORNER STEADY

Has a front hex drive & is
zinc plated.

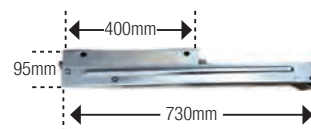

450-05322 700MM CORNER HEX DRIVE

(Bolt On)

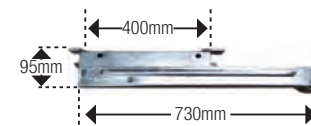

450-05350
500MM CORNER
STEADY

With wheel, has a front hex drive & is zinc plated.

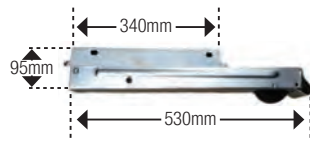

450-05360
600MM CORNER
STEADY

With wheel, has a front hex drive & is zinc plated.

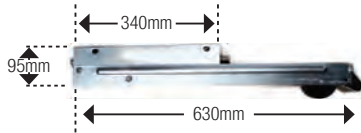

450-05410
ALKO CORNER STEADY
510MM

Has a hex drive, comes complete with a bigfoot making it ideal for softer ground and is zinc plated. (370mm closed)



450-05400
590MM DROP DOWN
CORNER STEADY



450-05402
ALKO BLACK 590MM
DROP DOWN CORNER
STEADY



450-05450
740MM DROP DOWN
CORNER STEADY



450-05452
ALKO BLACK 740MM
DROP DOWN CORNER
STEADY



450-05460
REPLACEMENT HANDLE TO
SUIT ALKO CORNER STEADIES



NYLON BUSHES FOR SPRINGS

450-05500
ALKO SPRING NYLON BUSH
- 1/2" X 7/8" X 45MM



450-05510
ALKO SPRING NYLON BUSH
- 9/16" X 7/8" X 45MM



450-05530
ALKO SPRING NYLON BUSH
- 9/16" X 3/4" X 45MM



450-05540
ALKO SPRING NYLON BUSH
- 5/8" X 7/6" X 60MM



SHACKLE PINS & NUTS

450-05630
ALKO SHACKLE PIN
- 9/16" X 3-1/2"

Comes with Nyloc Nut (Non Grease-able)



450-05640
ALKO SHACKLE PIN
- 9/16" X 3-1/2"

Long (Grease-able)



450-05660
ALKO SHACKLE PIN
- 5/8" X 3-1/4"

Long (Non Grease-able)



450-05730
ALKO SHACKLE PIN NYLOC NUT 5/8"
UNF

(Unified National Fine is a thread form with a 60 degree flank angle rounded roots and flat crests)



450-05740

ALKO SHACKLE PIN NYLOC NUT 9/16" UNF

(Unified National Fine is a thread form with a 60 degree flank angle rounded roots and flat crests)

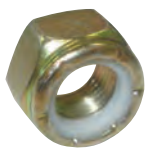

450-05800

ALKO WHEEL STUD KNURLED 1/2" UNF X 41MM

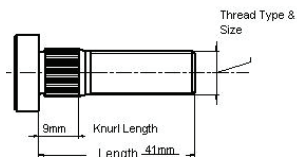

450-05850

ALKO WHEEL NUT 1/2" UNF

(Nut Angle 60 Degrees) - 20.5mm diameter



TOWSAFE TOW BALL WEIGHT SCALES

450-05990

TOWSAFE TOW BALL WEIGHT SCALE

Avoid unnecessary fines or even worse-accidents-by knowing your tow ball weight before you head out on a trip. Why do you need to know your tow ball weight? To put it simply, it is unsafe. Too much weight on your tow ball can cause excessive trailer sway, diminished handling and decreased braking ability. Not to mention it can be costly. The laws vary between states but on-the-spot fines can be issued if you exceed your RVs and your vehicles' tow ball weights. The TowSAFE Scale is compact and easy to store. It is made from heavy-duty metal but is gentle on your RV's coupling thanks to a soft rubber head. The gauge is easy to read and will handle up to 350kg. It has also been tested to Australian Standards (AS/NZS ISO10012:2004) so you know you're getting a quality product.



REICH CARAVAN WEIGHT CONTROLS

Caravan Weight Control provides you with complete control over the total weight and the partial loads on the individual wheels. The handy scale will help you prevent overloading as well as loading unevenly which will negatively affect driving behavior. Caravan Weight Control works reliably and precisely and is suitable for cars, delivery vehicles, motorhomes, caravans and trailers.

Three measuring programs for:

1. Caravan with one axle and support wheel
2. Caravan with tandem axle and support wheel
3. Motorhome

450-05910

REICH CARAVAN WEIGHT CONTROL YELLOW 1000KG

SPECIFICATIONS

Max. load per wheel: 1,000 kg (yellow)

Deviation: < 3 %

Temperature range: 0 to 50°C

Batteries: 3 x 1.5 V Alkaline Type AAA

Dimensions: 360 x 70 x 45 mm



450-05912

REICH CARAVAN WEIGHT CONTROL ORANGE 1500KG

SPECIFICATIONS

Max. load per wheel: 1,500 kg (orange)

Deviation: < 3 %

Temperature range: 0 to 50°C

Batteries: 3 x 1.5 V Alkaline Type AAA

Dimensions: 360 x 70 x 45 mm



PURPLELINE



A leading supplier to the RV market, offering a comprehensive range of remote caravan movers and one of the largest and most varied caravan security and safety product ranges in Australia. As a design-led company, Purple Line specialises in manufacturing innovative and affordable product solutions based on the needs of the market.

450-06002 KOJACK 4T JACK KIT (NEW) HIGHER EXTENSION

The ideal caravan jack that is able to lift a huge 4tons almost effortlessly. Its 3-piece jack handle ensures a smooth hydraulic action. The Kojack mounts under the caravan chassis, so there's no need to dismantle jockey wheels, and its compatible with both ball and block fittings to match most Australian caravans such as Goldstream, Elite and Jayco. Each kit includes: x1 4ton hydraulic Kojack, x1 ball fitting, x1 block fitting, x1 100mm extension, x1 Allen key, x1 3-piece jack handle, x1 fitted carry case and attachment collars.

SPECIFICATIONS

Weight: 12kg

Lift Range: 220mm (more if extension pieces are used)



450-06010 KOJACK BASEPLATE

Kojack® Baseplate adds stability: If you have a Purple Line® Kojack® 4 tonne caravan jack and want to make it even more stable and secure, the new Kojack® Baseplate is the answer. Ideal for soft ground, gravel or sand, Baseplate gives you a footprint three times the size of the Kojack® itself, which means three times the stability and a third of the downward pressure. It clips onto the Kojack® easily and securely and can also double as a secure footing for your jockey wheel.

Features

- > Can be used under jockey wheels to keep them in place and stop them from sinking
- > Spring loaded latch keeps the jack in place
- > Solid metal construction
- > The ideal upgrade for kojack jack
- > Suitable for most terrain including: sand, mud, grass, bitumen and gravel
- > Australian designed and developed
- > 2 Year warranty



450-06032**PURPLELINE TORPEDO HITCH PIN LOCK**

Add extra security to your vehicle

- > Towing rating 3500kg
- > Resistant to cutting, drilling & gas freezing
- > Suits class 4 receiver up to 75mm
- > Compliant with Australian Standards: 4177.1-2004

**450-06040****SOCKET EXTENSION**

An extender socket great for use on corner steady legs and the Kojack Leveller (to stabilise, raise or lower an RV). It can also be used to tighten or loosen other bolts and nuts provided they are 19mm in size. Made from high tensile steel and designed for use with a torque sensitive rechargeable drill.

**450-06050****SOCKET EXTENSION WITH UNIVERSAL JOINT**

Similar to the Socket Extension (above) except that it has a universal joint to facilitate tight spots. It can also be used to tighten or loosen bolts and nuts of 19mm, and is also made from high tensile steel.

**450-06064****NEMESIS WHEEL CLAMP**

The Nemesis wheel lock is made from specially hardened high tensile steel which is resistant to cutting and drilling and incorporates an exclusive high security 9-lever barrel lock, resistant to picking, drilling and gas freezing. The lock is made by Lowe and Fletcher (UK). It is supplied with a handy carry bag to store the unit when not in use. Built with composite metals, resistant to cutting, drilling and gas freezing. Incorporating a seven-pin anti-pick and anti-drill locking bolt with a tubular anti-copy key. Strong, secure and tough, it remains quick and easy to fit.



Suitable for steel and alloy wheels. New Model, 'one size fits all' - suitable for on and off road wheels up 17" and tyres up to 275mm cross-section. Now comes with three keys. The Nemesis wheel lock is the perfect highly visible deterrent.

Ideal for

- > Cars
- > Large Off-Road Tyres
- > Some light commercial vehicles (check wheel/Tyre combinations)
- > Motorhomes
- > Caravans
- > Camper Trailers
- > Boat trailers
- > Horse floats
- > General trailers
- > The Purpleline Nemesis comes with a 2 year warranty.

450-06059**KOJACK 150MM EXTENSION PIECE****450-06072****PURPLELINE ANTI THEFT PACK**

Complete Security Kit keeps you safe: Purple Line® has made it a whole lot easier to guard your caravan against thieves with its new Complete Security Kit, which combines the tough Samurai wheel clamp and Saracen® hitch lock in one compact, easy-to-use kit. Keyed alike for maximum convenience, both units have Purple Line's tough, 7-pin locking mechanism, as also used in the big Nemesis® wheel clamp and the Saracen Australian Hitch Lock. All in a convenient carry bag and backed by a 2 year warranty.

**Features****Samurai Wheel Clamp**

- > Simple to use, compact and quick fit
- > Fits tyre widths 145 to 275mm
- > Suitable for both on and off road wheels
- > 2 Year warranty

Saracen Hitch Lock

- > High security hitch lock
- > Quick and easy to fit
- > Resistant to cutting, picking, drilling and gas freezing
- > Made from high strength composite materials
- > 2 Year warranty

450-06085

GULLWING EURO HITCH LOCK

Designed to fit Alko stabilizer hitches AKS2004 and AKS3004, found predominantly on European RVs such as Bailey, Swift and Adria. It is highly secure, easy to fit and takes a couple of minutes to install. The Gullwing can be fitted to a van whether it is hitched or not.



450-06086

SARACEN ULTRA HITCH LOCK

The Saracen Ultra hitch lock suits Australian standard 50mm ball hitches and fits both when HITCHED and UNHITCHED.

Saracen Ultra suits any trailer with a standard 50mm ball hitch - boat and work trailers, caravans and camper trailers, horse floats, box trailers, car and motorcycle trailers - any trailer at all.



FEATURES

- > Made from specially hardened high strength steel
- > Resistant to cutting and drilling
- > Incorporates a high-security, 7-pin barrel lock, resistant to picking, drilling and gas freezing.
- > Suits Australian standard 50mm ball hitches
- > Fits both when HITCHED and UNHITCHED.

450-06088

SARACEN OFF ROAD HITCH LOCK

Today's tough Aussie off-road vans are increasingly fitted with the Vehicle Components Hitchmaster® DO35 articulated hitch, and now Purple Line® has developed a tough new hitch lock to protect it. The new Saracen® Off-Road hitch lock provides the same combination of toughness and easy fitting for the DO35 as the standard Saracen® models do for standard 50mm ball hitches. As with all Purple Line® anti-theft products, it features tough metal construction, engineered to give maximum protection for Aussie caravanners. It comes with Purple Line's tough, 7-pin locking mechanism, and is fitted simply by placing the backing plate in position, clamping over the cover and locking the stout locking pin. Backed by a 2 year warranty, it is as tough as the tough Aussie vans it protects - and it makes life even tougher for would-be thieves.



It has all the proven Saracen features including

- > High strength steel construction
- > Anti-pick seven-pin cylinder lock
- > Anti-copy tubular key
- > Suits V1, V2 & V3 DO35

450-06090

AEROPLUS CARAVAN WIND DEFLECTOR

Proven to reduce drag, the AeroPlus improves towing stability by directing airflow over your RV. This in turn, helps to minimize wear and tear to your tow vehicle whether it be mechanical or your tyres. It is made from ABS plastic and fits most 4WDs, SUVs and station wagons. The AeroPlus is easily fitted onto an existing horizontal roof rail by means of two clamps which are tightened by hand. As you drive, it directs the air over the top of your RV and thus reduces drag and improves fuel economy. It is suitable for use on most roof rails such as Rola, Rhino and Thule (providing that the rail is not wider than 80mm). Comes with angled spacers to increase the angle of the AeroPlus and a two year manufacturer's warranty.

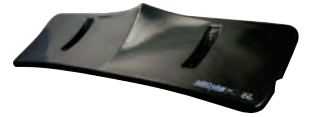

SPECIFICATIONS

Weight: 7kg (including packaging and fittings)
3.5kg (ABS plastic tail only)
Dimensions: 135W x 20H (cm)

Note: The AeroPlus has been wind tunnel tested up to a speed of 60mph (96kmph). It is therefore advised that if travelling whilst the AeroPlus is fitted, 96kmph is not exceeded. Drivers should always adhere to the road rules of the state they are travelling in.

450-06082

SARACEN AUSTRALIAN HITCH LOCK V2

The new and improved Saracen V2 features a unique tow chain lock feature allowing the user to lock their tow chains & hitch together. To further aid security, Saracen V2 also features additional hardened steel collars around the edges of the pin lock.



Made from especially hardened, high tensile steel, the Saracen is a high security hitch lock that is resistant to cutting and drilling. It is a quick and easy to fit solution to prevent your RV from being towed away. Featuring a Lowe and Fletcher lock, which is also resistant to picking and freezing, the Saracen comes with two keys and is suitable for use on most Australian caravan coupling hitches.

SPECIFICATIONS

Compatible with the following hitches: Alko, Trigg Boss, Meher, Trojan and some other standard Australian hitches.

Comes with a one year manufacturer's warranty.

450-06400
MILENCO INTERNAL
UNIVERSAL SILVER
THERMAL CAB BLIND

This one-size-fits-all blind features high quality, black sucker pads with their own handles to stop any distracting light through for you to get a good night sleep! For optimum performance in winter conditions, warm up demister before removing.



450-08010
MILENCO MGI WEDGE
LEVEL WITH CHOCK

A pack consisting of 1x MGI Wedge Level (450-08006) and 1x MGI Chock (450-08008).



450-08002
MILENCO QUATTRO LEVEL
PAIR (160MM MAX LIFT)

Sold in pairs complete with carry case. Europe's best-selling large Level lifts to 160mm and incorporates a lattice, high-grip upper tread surface. It pockets the wheel at every height and features a solid base to stop sinking on soft terrain. The high grip leading edge prevents slippage when approaching and avoids the need for gripper plates.



450-08020
MILENCO STACKA TYRE
SAVER
(TWIN PACK)

These heavy duty tyre savers feature a durable design and a solid base to prevent sinking on soft terrain. Suitable for twin axle, single axle, and tag axle.



SPECIFICATIONS

Capacity: 1500kg Per Wheel = 6000kg Motorhome or 3000kg Caravan

SPECIFICATIONS

Dimensions: 20cm H x 24.5cm W x 81cm L
 Height of Each Step: 4cm/8cm/12cm/18cm
 Weight: 3.8kg Per Level
 Capacity: 1500kg Per Wheel = 6000kg Motorhome or 3000kg Caravan

450-08006
MILENCO MGI WEDGE
LEVELS (TWIN PACK)

A conventional wedge-shaped Level with 50% Base and 50% Top surface area featuring a lightweight, strong construction. The high grip leading edge removes the need for gripper plates. Compatible with MGI Milenco Wedge Level Chock.



450-08022
MILENCO GIANT LATTICE
TREAD GRIP MAT (TWIN
PACK)

This heavy-duty, extra large set of Grip Mats is designed to provide excellent performance in wet conditions. The Lattice design allows them to be linked together without being tied.



SPECIFICATIONS

Dimensions Per Mat: 106cm L x 33cm W

SPECIFICATIONS

Dimensions (approx): 11cm H x 18cm W x 46cm L
 Height of Each Step: 4cm/8cm/12cm/18cm
 Weight: 1kg Per Level
 Capacity: 1000kg Per Wheel = 4000kg Motorhome or 2000kg Caravan

450-08008
MILENCO MGI WEDGE LEVEL
CHOCK

An extra wide chock with side handles to reduce the risk of hand trap. Compatible with MGI Milenco Wedge Levels. Available singularly.



STONE SHIELDS



Protect your RV, and prolong the life of its paintwork, by installing a Stone Shield. Supplied as a flat pack, it is quick and easy to install of the A-frame of your caravan or camper trailer. Made from tough rip stop mesh (resistant to rips or tears), the Stone Shield stops stones (and other hard debris) from chipping, or potentially even denting your RVs paintwork. Comes with two extra-large rubber mud flaps to protect the undercarriage of your caravan or camper trailer.

450-06500 CARAVAN STONE SHIELD

SPECIFICATIONS

Dimensions: 2310mm x 500mm
Net Weight: 16.0kg



450-06520 CAMPER TRAILER STONE SHIELD

SPECIFICATIONS

Dimensions: 1800mm x 500mm
Net Weight: 14.8kg



450-06510 CAMPER VAN STONE SHIELD

SPECIFICATIONS

Dimensions: 2150mm x 500mm
Net Weight: 15.7kg

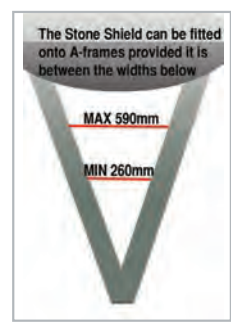

450-06613
STONE SHIELD RUBBER
MUD FLAPS X2 #9 T/S
TRAILER

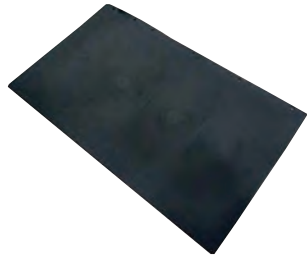

500-99994
RETRO REFLECTOR



450-06608
STONE SHIELD RUBBER
MUD FLAPS X2 #9 T/S
BOTH CARAVAN & CAMPER



450-06614
STONE SHIELD RIP STOP
MESH #10 T/S TRAILER



450-06611
STONE SHIELD RIP STOP
MESH #10 T/S CAMPER



450-06609
STONE SHIELD RIP STOP MESH
#10 T/S CARAVAN



Lined area for notes with horizontal dotted lines.

A series of horizontal dotted lines for writing notes.

Handwriting practice area with 20 horizontal dotted lines.

SECTION 4

ELECTRICAL EQUIPMENT

(Product Group - 500)

| | |
|----------------------------------|----------------------|
| Fans and Smoke Alarms | 156 |
| Battery & Accessories | 157 - 159 |
| Narva Electrical Fittings | 171 - 175 |
| Power Inlets and Outlets | 175 - 177, 181 - 182 |
| Power Points & Switches | 176 - 182 |
| Electrical Leads | 179 - 180 |
| CMS Equipment | 180 - 182 |
| 15amp-10amp Adaptors | 182 - 183 |
| NARVA Accessory Sockets | 183 - 184 |
| Solar Panels | 185 - 186 |
| Tyre Inflators (Air Compressors) | 186 - 187 |
| Trailer Plugs and Sockets | 187 - 189 |
| Auto Cable | 189 - 194 |
| Caframo Fans | 195 - 196 |
| Briggs and Stratton Generators | 197 |

LIGHTING EQUIPMENT

(Product Group - 500)

| | |
|----------------------------|-----------|
| Lights and Lenses | 160 - 162 |
| Truck and Trailer Lighting | 163 - 165 |
| LEDS | 166 - 167 |
| Reflectors | 168 |
| Sphere™ Wireless Lighting | 169 - 170 |

GAS EQUIPMENT

(Product Group - 550)

| | |
|-----------------------------|-----------|
| Gas Regulators and Hoses | 198 - 201 |
| Gas Unions, Nuts and Valves | 201 - 203 |
| Gas Cylinders and Cradles | 203 |
| Gas Detector | 203 |



500-00082 FAN AND LIGHT COMBO (WHITE)

Suitable for use in Jayco Campers and Expandas, this reading light has a 2-speed fan. It has a 1/4" (6.4mm) jack which allows it to fit into an existing 12V internal light (such as 500-05004, 500-05005, 500-05006 and 500-05007). There are also two plastic U-brackets on the rear/top that will clip onto a 3/4" - 1" (19.1mm - 25.4mm) camper support pole. Alternatively, it can be hung using the single U-bracket at the back to hang it vertically. Made in the USA to Australian and NZ standards, it also features a curly cord that extends up to 8ft (2.4mt) and comes with a globe*.



* You can replace this globe with a Coast LED, either 500-05758 or 500-05760 will fit.

SPECIFICATIONS

Power: 12VDC, 1.3A (max)
Dimensions: 250L x 145W (mm)

500-00200 SAFETY HUSH SMOKE ALARM

Ideal for fast flaming fires, the Hush Smoke Alarm is easy to install with no wiring necessary. It has a feature that enables the alarm to be switched off for 10 minutes in case of false alarms. It also has an ionisation sensing chamber which automatically resets once the smoke is cleared. This smoke alarm comes with a 9V battery which lasts approximately nine months. A warning signal will sound when the battery is running low.



500-00730 SETEC DRIFTER

The Setec Drifter is an LCD display unit with the capacity to monitor up to four water tanks and a 12V battery. This means that you'll know when you're running low on fresh water or when your waste tank needs to be emptied (if you choose this as an option to monitor), all whilst observing your battery's status (current going in and out). It is compatible with any 12V lead acid battery, including VRLA, AGM, Gel and even the traditional non-sealed batteries.



SPECIFICATIONS

DC Power Input: 8-15V DC, 0.7-0.35A
USB Output: 5V DC at 0.9A C-Tick Approved
Complies with IEC 61010-1, ED: 2001, CISPR 11:2009
Dimensions: 149L x 85H x 22W (mm)
Weight: 0.21kg

500-00749 SETEC DRIFTER WATER SENSOR TANK SET

The Setec Drifter, part number 500-00730 (above) comes with wiring for up to two tanks. You could choose to utilize this to monitor two water tanks or, one water tank and one waste tank. Should you want to monitor extra tanks, a Water Sensor Tank Set must be purchased (one set per tank).

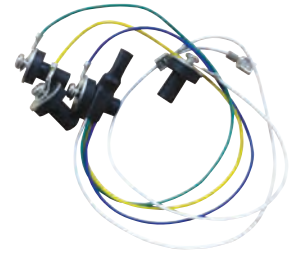

500-00222 QUELL PDO4 CARBON MONOXIDE DIGITAL DISPLAY ALARM

Protect your family and safeguard your RV by adding a Carbon Monoxide alarm, these units are cost effective and easy to install. What is Carbon Monoxide? Carbon monoxide (CO) is a highly poisonous gas with no taste, colour or smell.



Carbon monoxide (CO) alarms detect the early presence of carbon monoxide emitted from gas sources such as heating and cooking systems, vehicle engines, fuels and blocked chimneys. CO alarms are intended to supplement conventional smoke alarms, not replace them. A CO alarm is not a smoke alarm and, therefore, will not satisfy legal requirements regarding the installation of smoke alarms in the home.

FEATURES

- > Peak level memory Displays the highest CO concentration measured since the last reset
- > Self-activation Alarm automatically activates when attached to the mounting bracket
- > Test/Reset button Tests the alarm circuitry and horn. Resets memory after the alarm has sounded
- > LED indicators Flashing green LED every 30 seconds indicates the unit is operating properly. Pulsing red LED with alarm indicates a dangerous level of carbon monoxide has been detected. Amber LED indicates the unit is in fault mode
- > Deactivation switch Disables the alarm to allow for safe battery disposal once the unit has reached the end of its 10-year life
- > 10-year limited warranty Provides peace-of-mind with a decade of carbon monoxide detection
- > 3 x AA batteries included

SPECIFICATIONS

Dimensions: 120mm x 75mm x 40mm

SPHERE BATTERIES

Sphere 12V Valve Regulated AGM Rechargeable Batteries are available in two models to suit most needs. Ideal for use in caravanning and camping, the AGM design offers improved discharge and recharge efficiencies. They require less maintenance, are spill proof and are safer for you and the environment compared to conventional alternatives.

500-00820

SPHERE 12V 100AH VALVE REGULATED AGM RECHARGEABLE BATTERY



SPECIFICATIONS

Internal resistance: Fully Charged at 25°C: 4.9 Ohm
 Max. Discharge Current: 1200A(5s)
 Operating Temperature
 Discharge: -15 ~50°C
 Charge: 0 ~40°C
 Storage: -15 ~40°C
 Charge Method (25°C)
 Max. Charge current: 40
 Cycle use: 14.4-15.0v(-30mv/ °c)
 Float use: 13.5-13.8v(-20mv/ °c)
 Self Discharge: 3% of capacity declined per month at 20°C
 Dimensions: 307L x 168W x 214H (mm)

500-00822

SPHERE 12V 120AH VALVE REGULATED AGM RECHARGEABLE BATTERY



SPECIFICATIONS

Internal resistance: Fully Charged at 25°C: 4.9 Ohm
 Max. Discharge Current: 1200A(5s)
 Operating Temperature
 Discharge: -15 ~50°C
 Charge: 0 ~40°C
 Storage: -15 ~40°C
 Charge Method (25°C)
 Max. Charge current: 40
 Cycle use: 14.4-15.0v(-30mv/ °c)
 Float use: 13.5-13.8v(-20mv/ °c)
 Self Discharge: 3% of capacity declined per month at 20°C
 Dimensions: 330L x 171W x 219H (mm)

SPHERE LITHIUM BATTERIES

Sphere lithium batteries are the future of mobile power storage. Lithium batteries are much lighter than traditional lead acid and AGM batteries and deliver unrivalled cycle life, more than four times more cycles compared to lead acid and AGM batteries.

Perfect for use in caravans, marine, camping and home storage applications, Sphere Lithium batteries are fully sealed and feature a built-in battery management system for safety.

If you are replacing an existing deep cycle lead acid or AGM battery you can continue to use your same battery charging system and the built-in battery management system will do the rest for you. You will also notice that lithium batteries charge more efficiently than lead acid and AGM batteries so the recovery will be much quicker.

Sphere lithium batteries use active cell balancing technology to balance the internal battery cells not only whilst charging but also whilst discharging. This assist's in getting the battery as close to 100% charge levels as possible.

- > 100AH AND 120AHLithium Ion
- > 2000+Cycles
- > Built in advanced BMS with Dynamic cell balancing
- > Lightweight
- > 5 Year Warranty
- > Can be connected in series or parallel. Maximum in series voltage of 30.4V

Note: These batteries can't be used to start motor vehicles

500-00831

SPHERE 12V 100AH LITHIUM RECHARGEABLE BATTERY



SPECIFICATIONS

Capacity: 100AH
 Voltage: 12.8VDC
 Discharge Rate Max: 100A
 Maximum Pulse Rate (3 sec): 250A
 Nominal Charge Rate: 30A
 Max Charge Rate: 60A
 Cycles@ 100% DOD: 2000
 Operating Range : -20°C to +60°C
 Weight: 12.6Kg
 IP Rating: IP65

500-00833

SPHERE 12V 120AH LITHIUM RECHARGEABLE BATTERY



SPECIFICATIONS

Capacity: 120AH
 Voltage: 12.8VDC
 Discharge Rate Max: 100A
 Maximum Pulse Rate (3 sec): 250A
 Nominal Charge Rate: 30A
 Max Charge Rate: 60A
 Cycles@ 100% DOD: 2000
 Operating Range : -20°C to +60°C
 Weight: 14.2Kg
 IP Rating: IP65

500-00835
SPHERE 12V 200AH LITHIUM RECHARGEABLE BATTERY



SPECIFICATIONS

- Capacity: 200AH
- Voltage: 12.8VDC
- Discharge Rate Max: 100A
- Maximum Pulse Rate (3 sec): 250A
- Nominal Charge Rate: 40A
- Max Charge Rate: 60A
- Cycles@ 100% DOD: 2000
- Operating Range : -20°C to +60°C
- Recommended Charge Rate: 30A
- Maximum In-series voltage: 30.4V

CAMCO BATTERY BOX

500-02012
BATTERY BOX
- LARGE. C/W LID
+ STRAP
328L X 188D X 195H



500-02032
CAMCO BATTERY BOX - SMALL
 Camco RV Standard Battery Box is a black, lightweight, heavy-duty corrosion-resistant polypropylene box which is designed to secure and protect batteries. It includes a lift-off lid, durable woven hold-down strap, foot clamps and stainless steel screws.



- > Includes lift-off lid, durable woven hold-down strap, foot clamps and stainless steel screws
- > Lightweight, heavy-duty corrosion-resistant polypropylene box
- > It has internal dimensions of 273L x 184D x 200H (mm) with 50mm additional head room for battery terminals.

500-02034
CAMCO BATTERY BOX - LARGE

Camco RV Large Battery Box is a black, lightweight, heavy-duty corrosion-resistant polypropylene box which is designed to secure and protect batteries. It includes a lift-off lid, durable woven hold-down strap, foot clamps and stainless steel screws.



- > Includes lift-off lid, durable woven hold-down strap, foot clamps and stainless steel screws
- > Lightweight, heavy-duty corrosion-resistant polypropylene box
- > It has internal dimensions of 336L x 184D x 219H (mm) with 50mm additional head room for battery terminals.

500-02036
CAMCO REPLACEMENT BATTERY BOX STRAP & HARDWARE



Camco's Replacement Strap for Battery Box measures 990mm long x 38mm wide. It is made of woven polypropylene and includes the hardware to attach it to the battery box.

- > 990mm long x 38mm wide
- > Includes hardware to attach to battery box
- > Made of woven polypropylene
- > Heavy-duty and durable
- > Easy to install

500-02038
CAMCO STANDARD BATTERY TRAY - PLASTIC

It is heavy-duty acid-resistant plastic with stainless steel hardware

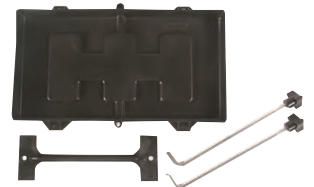

- > Heavy-duty acid-resistant plastic
- > Stainless steel hardware

500-02040
CAMCO LARGE BATTERY TRAY - PLASTIC

It is heavy-duty acid-resistant plastic with stainless steel hardware.

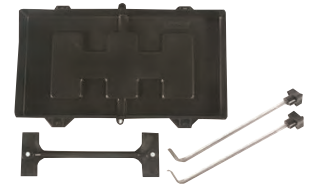

- > Heavy-duty acid-resistant plastic
- > Stainless steel hardware

ANBI SWITCH BATTERY ISOLATOR

The ANBI Battery Switch eliminates drainage of stored power by isolating the battery from power-hungry components like clocks, and general energy leakage. Installation is quick and easy and can be completed in less than 15 minutes.

Even when your ignition key is off, there are still components that draw current and continue to drain your battery. That's why it's common to find it flat when you go to start a vehicle, like a caravan, classic car, or ride-on mower after it's sitting for an extended period of time. This is both inconvenient and costly as a completely flat dead battery can often become damaged if left uncharged for an extended period.

ANBI also provides a theft deterrent by virtually immobilising the vehicle when activated. This can result in significant savings on insurance premiums. Make sure your steed is ready to go when you are, install an ANBI Battery Switch today!

500-02120

ANBI SWITCH - BATTERY ISOLATOR

The ANBI Switch is a simple, high quality, robust solution to help you avoid flat batteries.

- > 5 Year Warranty
- > Simple installation
- > Suitable for wide range of applications
- > Proven anti-corrosive. Exceeds international standards for salt and sea spray.
- > Accelerated life tested for proven durability
- > Designed and manufactured in Australia



500-02124

ANBI SWITCH - EXTENSION KIT

Allows the user to fit the ANBI Switch more remotely, out of sight if needed or to avoid a tight space.



500-02121

ANBI SWITCH CARAVAN & CAMPERTRAILER - BATTERY ISOLATOR

Nothing's more frustrating than going to hitch-up your caravan or camper only to discover that you've fallen foul of a flat battery! Now you can avoid disappointment and inconvenience, with an inexpensive and simple to install ANBI Battery Switch. The ANBI Battery Switch eliminates drainage of stored power, by isolating the battery from energy leakage. Installation is quick and easy and can be completed in less than 15mins. Make sure you're always ready to go and install an ANBI Battery Switch today!



SPECIFICATIONS

Vibration tested to Australian Standard
 1200A at 12V for 5ms
 600A at 24V for 5ms
 120A at 12V continuous load max
 60A at 24V continuous load max

EXTERNAL LIGHTING

500-01014
BARGMAN LIGHT
REPLACEMENT LENS ONLY



500-01030
HALOGEN PORCH LIGHT
WITH SWITCH
 Porch light c/w switch white
 base - clear lens 12V



500-01033
LENS ONLY TO SUIT
CURRENT PORCH LIGHT
(CLEAR)



500-01036
LED ANNEX LIGHT
 Has a white base that mounts
 onto your RV wall (comes with
 screws for installation). Also
 has a clear lens.
 Note: This is an interior LED
 light. It can be used on the
 exterior provided it is sealed.



500-01038
ANNEX LIGHT WITH
SWITCH - BLACK



500-01051
LENS FOR COAST LIGHT
WITH GRAB HANDLE



500-01055
REPLACEMENT
SWITCH, LOCKING
RING + BUTTON
COVER T/S
XC9HANDLE03/
C4323B. C4235



500-01057
GRAB HANDLE
WITH LED

Featuring a simple and modern design, the latest Coast Grab Handle sheds light around your RV entry area. Turn it on or off (as required) using the trigger switch found on the underside of the handle. Comes with a five year manufacturer's warranty.



SPECIFICATIONS

Dimensions: 175H x 149W x 50D (mm)
Voltage: 10 - 36V
Material: Polycarbonate

500-01059
GRAB HANDLE WITH LIGHT
- BLACK



COAST LED ASSIST HANDLES

Available in 3 colours - Black, White and Chrome, Coast to Coast LED Assist Handles offer practical convenience, stylish modern design and the following great features:

- > LED mode touch switch conveniently located behind the handle
- > IP65 water resistance, built for outdoor use
- > Natural white LED illumination
- > Blue LED courtesy light

SPECIFICATIONS

Voltage: 12V
 White Power Draw: 2W
 Blue Power Draw: 0.8W
 Light Operation: White - Blue - Off
 IP Rating: IP65
 Carton Quantity: 23

500-01062 ASSIST HANDLE W/ 12V LED LIGHT BLACK ABS



500-01064 ASSIST HANDLE W/ 12V LED LIGHT WHITE ABS



500-01066 ASSIST HANDLE W/ 12V LED LIGHT CHROME ABS



TEARDROP LED ASSIST HANDLE

Great for lighting up your awning area, the Coast LED Awning Lights are Features

- > Stylish and functional design
- > LED mode touch switch
- > IP67 water resistance, built for outdoor use
- > Daylight white LED illumination

SPECIFICATIONS

Voltage: 12V
 White Power Draw: 2W
 Light: Daylight White (6,000K)
 IP Rating: IP67

500-01072 COAST TEARDROP LED ASSIST HANDLE W/ 12V LIGHT - IP67 - WHITE



500-01074 COAST TEARDROP LED ASSIST HANDLE W/ 12V LIGHT - IP67 - BLACK



COAST LED AWNING LIGHTS

Great for lighting up your awning area, the Coast LED Awning Lights are waterproof, and easily installed onto your RV by means of two screws. Featuring a pure white light, it runs on 12V DC and is available in two sizes.

500-01250
COAST LED AWNING LIGHT
PURE WHITE (20CM)
 Contains 9 LEDs



500-01252
COAST LED AWNING LIGHT PURE WHITE (40CM)
 Contains 18 LEDs

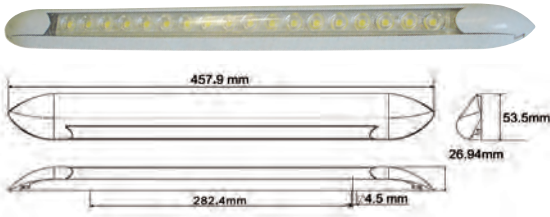

500-01268
LED INTERNAL ROOF
LIGHT.53R TOUCH
WARM WHITE



SPECIFICATIONS

Length: 158.5 mm
 Width: 118.5 mm
 Total Height: 16.5 mm

500-01270
LED INTERNAL ROOF
LIGHT.53R TOUCH
WARM WHITE

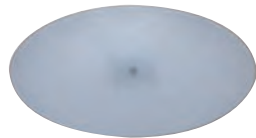

SPECIFICATIONS

Length: 236.5 mm
 Width: 126.5 mm
 Total Height: 16.5 mm

LED OVAL LIGHTS

500-01260
COAST LED OVAL LIGHT 12V WITH
JACK



500-01262
COAST LED OVAL LIGHT 12V

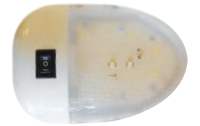

500-01264
COAST LED OVAL LIGHT 12V
DUAL



500-01266
COAST LED OVAL LIGHT 12V
DUAL WITH JACK



12V INTERNAL LIGHTS

500-05000
WHITE INTERIOR DOME LIGHT
WITH ON/ OFF ROCKER SWITCH



Specifications

Dimensions (mm): 190W x 109H x 50D

500-05001
SILVER INTERIOR DOME LIGHT
WITH ON/ OFF ROCKER SWITCH



500-05002
WHITE DUAL INTERIOR DOME LIGHT
WITH ON/ OFF ROCKER SWITCH



SPECIFICATIONS

Dimensions (mm): 280W x 109H x 50D

500-05010
LENS TO SUIT INTERIOR DOME LIGHTS
(BOTH DUAL AND SINGLE INTERIOR
LIGHTS)



NARVA L.E.D LIGHTS

500-05020
LED SIDE MARKER LAMP RED/
AMBER LED CHROME BASE



SPECIFICATIONS

Dimensions (mm): 74 x 38

500-05022
LED SIDE MARKER LAMP RED/
AMBER WITH WHITE BASE



SPECIFICATIONS

Dimensions (mm): 74 x 38

500-05024
LED FRONT END OUTLINE MARKER
LAMP WHITE WITH CHROME BASE



SPECIFICATIONS

Dimensions (mm): 74 x 38

500-05026
LED FRONT END OUTLINE MARKER
LAMP WHITE WITH WHITE BASE



SPECIFICATIONS

Dimensions (mm): 74 x 38

500-05028
LED FRONT END OUTLINE MARKER
OR EXTERNAL CABIN LAMP AMBER
WITH CHROME BASE



SPECIFICATIONS

Dimensions (mm): 74 x 38

500-05030
LED FRONT END OUTLINE MARKER
OR EXTERNAL CABIN LAMP AMBER
WITH WHITE BASE



SPECIFICATIONS

Dimensions (mm): 74 x 38

500-05032
LED REAR END OUTLINE MARKER
LAMP RED WITH CHROME BASE
0.5m of cable is provided. 9 - 33V



SPECIFICATIONS

Dimensions (mm): 74 x 38

500-05034
LED REAR END OUTLINE MARKER
LAMP RED WITH WHITE BASE



SPECIFICATIONS

Dimensions (mm): 74 x 38

500-05036
LED SIDE DIRECTION INDICATOR
LAMP AMBER WITH CHROME
BASE
0.5m of cable is provided. 9 - 33V



SPECIFICATIONS

Dimensions (mm): 74 x 38

500-05040
LED LICENCE PLATE LAMP
BLACK HOUSING



SPECIFICATIONS

Dimensions (mm): 95 x 60

500-05042
LENS TO SUIT SIDE MARKER
LAMP



SPECIFICATIONS

Dimensions (mm): 114 x 58

500-05110
SIDE MARKER LAMP
- RED/AMBER



SPECIFICATIONS

Dimensions (mm): 120 x 65

NARVA LAMPS & REFLECTORS

500-05100
REAR COMBO LIGHT
- STOP/PARK/DIRECTION
INDICATOR
 With shallow body.



SPECIFICATIONS
 Dimensions (mm): 275 x 93

500-05102
HEAVY DUTY REAR COMBO
LAMP - STOP/DIRECTION
INDICATOR
 With grey base.



SPECIFICATIONS
 Dimensions (mm): 405 x 130

500-05104
HEAVY DUTY REAR COMBO
LAMP
- STOP/PARK/REVERSE/
DIRECTION
INDICATOR



SPECIFICATIONS
 Dimensions (mm): 650 x 132

500-05112
CLEAR FRONT END OUTLINE
MARKER LAMP WITH BUILT IN
REFLECTOR



SPECIFICATIONS
 Dimensions (mm): 85 x 38

500-05114
CLEAR FRONT END OUTLINE
MARKER LAMP WITH RUBBER
BOOT & BUILT IN REFLECTOR



SPECIFICATIONS
 Dimensions (mm): 97 x 48

500-05120
NARVA SIDE DIRECTION
INDICATOR LAMP (AMBER)



SPECIFICATIONS
 Dimensions (mm): 120 x 52

500-05015
NARVA LED BLACK AWNING
LIGHT



500-05119
NARVA LARGE BASE LED
AWNING LIGHT

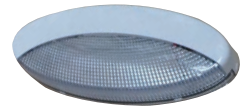

500-05123
NARVA LED AWNING LIGHT
 A low profile LED lamp that is great for positioning underneath an awning canopy on RVs. It has a classic shape with a white base (9-30VDC, 3W).



SPECIFICATIONS
 Dimensions (mm): 250W x 87H x 17-35D

500-05124
NARVA FRONT END OUTLINE
MARKER & FRONT POSITION
LAMP (CLEAR)



SPECIFICATIONS
 Dimensions (mm): 120 x 52

500-05125
NARVA REAR END OUTLINE
MARKER & REAR POSITION
LAMP RED



Can use 12V or 24V globes. ADR approved.

SPECIFICATIONS
 Dimensions (mm): 120 x 52

FESTOON GLOBES

500-05150
12V 3W GLOBE
 10 pack.



SPECIFICATIONS
 Dimensions (mm): 8 x 28

500-05152
12V 5W GLOBE
 10 pack.



SPECIFICATIONS
 Dimensions (mm): 11 x 36

500-05154
12V 5W GLOBE
 10 pack.



SPECIFICATIONS
 Dimensions (mm): 11 x 41

500-05156
12V 10W GLOBE
 10 pack.



SPECIFICATIONS
 Dimensions (mm): 11 x 36

500-05162
12V 18W GLOBE
 10 pack.



SPECIFICATIONS
 Dimensions (mm): 15 x 41

500-05164
12V 18W GLOBE
 10 pack.



SPECIFICATIONS
 Dimensions (mm): 15 x 44

COAST LED LAMPS

500-05500
COAST LED SIDE MARKER LAMP RED/AMBER
 Has a clear polycarbonate lens with a white bracket, a 0.5m wire outlet with blade terminals (12V)

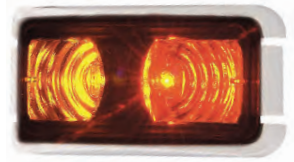

SPECIFICATIONS
 Dimensions (mm): 75 x 40

500-05502
COAST LED FRONT POSITION LAMP WHITE
 Has a clear polycarbonate lens with a white bracket, a 0.5m wire outlet with blade terminals (12V)



SPECIFICATIONS
 Dimensions (mm): 75 x 40

500-05504
COAST LED FRONT MARKER LAMP AMBER
 Has a clear polycarbonate lens with a white bracket, a 0.5m wire outlet with blade terminals (12V)



SPECIFICATIONS
 Dimensions (mm): 75 x 40

500-05506
REAR POSITION LAMP RED
 Has a red polycarbonate lens with a white bracket, 0.5m wire outlet with blade terminals (12V)



SPECIFICATIONS
 Dimensions (mm): 75 x 40

4 SECTION LEDS

500-05520

COAST LED LICENSE PLATE LAMP (WHITE)

Has a polycarbonate lens with dark grey bracket & a 0.5m wire lead outlet. Note: there is no terminal or connector and two lamps are required for ADR compliance (12v DC)



500-05753

LED G4 REPLACEMENT BULB WITH SIDE PIN (COOL WHITE) 1.6W

Used to replace the traditional G4 halogen bulbs, it has x6 super bright LEDs and a luminous flux of 120 lumens. Operates on 12V DC.



SPECIFICATIONS

Dimensions (mm): 35 x 23

LED REPLACEMENT BULBS

500-05748

LED MR8 REPLACEMENT BULB (COOL WHITE) 0.8W

Used to replace traditional MR8 halogen bulbs, it has x6 super bright LEDs and a luminous flux of 60 lumens. Operating on 12V DC, it is the equivalent to a 10W MR8 halogen bulb.



SPECIFICATIONS

Dimensions (mm): 34 x 25

500-05754

LED G4 SINGLE REPLACEMENT BULB (COOL WHITE) 1W

Used to replace reading light bulbs, it has a single super bright LED and a luminous flux of 70 lumens. Operating on 12V DC, it is the equivalent to a 10W G4 halogen bulb.



SPECIFICATIONS

Dimensions (mm): 28 x 12

500-05751

LED MR16 REPLACEMENT BULB (COOL WHITE) 4W

Used to replace the traditional MR16 halogen bulb, has x3 super bright LED's and a luminous flux of 210 lumens. Operating on 12V DC, it is the equivalent to a 45W MR16 halogen bulb.



SPECIFICATIONS

Dimensions (mm): 50 x 47.8

500-05756

LED G4 REPLACEMENT BULB WITH SIDE PIN (COOL WHITE) 1.8W

Used to replace the traditional G4 halogen bulb, it has x12 super bright LEDs and a luminous flux of 150 lumens. Operating on 12V DC, it is the equivalent to a 27W G4 halogen bulb.



SPECIFICATIONS

Dimensions (mm): 42 x 30

500-05752

LED MR11 REPLACEMENT BULB (COOL WHITE) 1.8W

Used to replace the traditional MR11 halogen bulb, has x12 super bright LEDs and a luminous flux of 150 lumens. Operating on 12V DC, it is the equivalent to a 24W MR11 halogen bulb.



SPECIFICATIONS

Dimensions (mm): 34 x 34.6

500-05757

LED G4 REPLACEMENT BULB TOWER TYPE (COOL WHITE) 2.7W

Used to replace the traditional G4 halogen bulb, it has x18 super bright LEDs and a luminous flux of 210 lumens. Operating on 12V DC, it is the equivalent to a 27W G4 halogen bulb.



SPECIFICATIONS

Dimensions (mm): 45 x 15

500-05758**LED T10 REPLACEMENT BULB (COOL WHITE) 1.35W**

Used to replace the traditional T10 halogen bulb, it has x6 super bright LEDs and a luminous flux of 105 lumens. Operating on 12V DC, it is the equivalent to a 16W T10 halogen bulb.

**SPECIFICATIONS**

Dimensions (mm): 37 x 13

500-05760**LED T10 REPLACEMENT BULB (COOL WHITE) 2.7W**

Used to replace the traditional T10 halogen bulb, it has x18 super bright LEDs and a luminous flux of 210 lumens. Operating on 12V DC, it is the equivalent to a 35W T10 halogen bulb.

**Specifications**

Dimensions (mm): 55 x 27

500-05761**LED T10 REPLACEMENT BULB WEDGE TYPE (COOL WHITE) 1.76W**

Used to replace the traditional T10 halogen bulb, it has x13 super bright LEDs and a luminous flux of 150 lumens. Operating on 12V DC.

**SPECIFICATIONS**

Dimensions (mm): 43.2 x 10

500-05762**LED BA15S REPLACEMENT BULB (COOL WHITE) 2.7W**

Used to replace traditional BA15S halogen bulbs, it has a single connector parallel pin and x18 super bright LEDs. Operating on 12V DC, and with a luminous flux of 250 lumens, it is the equivalent to a 36W BA15S halogen bulb.

**SPECIFICATIONS**

Dimensions (mm): 49 x 15

500-05764**LED BA15D REPLACEMENT BULB (COOL WHITE) 2.7W**

Used to replace traditional BA15D halogen bulbs, it has a double connector parallel pin and x18 super bright LEDs. Operating on 12V DC, and with a luminous flux of 250 lumens, it is the equivalent to a 36W BA15D halogen bulb.

**SPECIFICATIONS**

Dimensions (mm): 49 x 15

500-05766**LED FESTOON REPLACEMENT BULB (COOL WHITE) 0.54W**

Used to replace traditional festoon halogen bulbs, it has x6 super bright LED's. Operating on 12V DC, and with a luminous flux of 36 lumens, it is the equivalent to a 5.4W festoon halogen bulb.

**SPECIFICATIONS**

Dimensions (mm): 42 x 24

500-05770**LED 2D FLUORESCENT TUBE REPLACEMENT LAMP (COOL WHITE) 10.1W**

Used to replace traditional round fluorescent lamps, it has x60 super bright LEDs. Operating on 12V DC, it has a luminous flux of 900 lumens.

**SPECIFICATIONS**

Dimensions (mm): 130 x 15

REFLECTORS

REFLECTORS

500-05550
COAST RECTANGULAR SCREW MOUNT REFLECTOR AMBER
 Has an acrylic lens and screw mount.

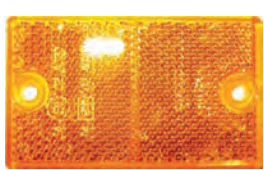

SPECIFICATIONS
 Dimensions (mm): 72 x 42

500-05552
COAST RECTANGULAR SCREW MOUNT REFLECTOR RED
 Has an acrylic lens and screw mount.

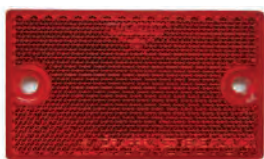

SPECIFICATIONS
 Dimensions (mm): 72 x 42

500-05554
COAST RECTANGULAR SCREW MOUNT REFLECTOR CLEAR
 Has an acrylic lens and screw mount.

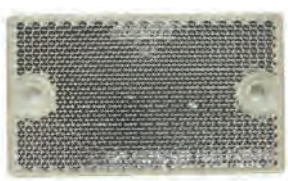

SPECIFICATIONS
 Dimensions (mm): 72 x 42

500-05556
REFLECTOR CLEAR RECTANGULAR SELF ADHESIVE 22 X 85MM ADR APPROVED

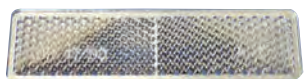

500-05558
REFLECTOR RED RECTANGULAR SELF ADHESIVE 22 X 85MM ADR APPROVED

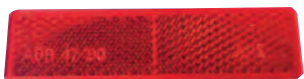

500-05560
REFLECTOR AMBER RECTANGULAR SELF ADHESIVE 22 X 85MM ADR APPROVED



500-05580
ROUND REFLEX REFLECTOR AMBER



SPECIFICATIONS
 Diameter: 57mm
 Height: 5mm

500-05582
ROUND REFLEX REFLECTOR RED

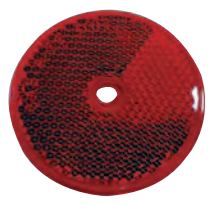

SPECIFICATIONS
 Diameter: 57mm
 Height: 5mm

SPHERE™ WIRELESS LIGHTING CONTROL SYSTEM



The Sphere™ Wireless Lighting Control System is the way of the future. Easily installed on any flat surface, the system requires no drilling, no wires and no hassle—a simple lighting system at its best! How does the system work you ask? Firstly you will need the 6-Channel Receiver and a selection of Wireless Switches (whichever you feel is best for your RV setup). The Receiver will control the lighting for up to six individual zones in your RV e.g. the kitchen or the bathroom. A simple pairing procedure allows for multiple switches to be programmed to each zone and vice versa.

A master OFF function is available with all switches, enabling you to turn all lights off in all zones with one simple button. Alternatively, for a true wireless experience, the remote control can be purchased.

500-07132 SPHERE WIRELESS LIGHT SWITCH REMOTE CONTROL

A six button, multifunction remote control with six available channels enabling the user to tailor the system to their needs. The Remote Control is a handy accessory to keep in your pocket. If, for example, you have spent the day exploring your surroundings, with the Remote Control in your pocket, you can turn your RV lights on as you approach. It will work up to 50m away (provided nothing obscures the signal). Comes with a belt and clip for the user to wear when away from their RV.



500-07134 SPHERE WIRELESS LIGHT SWITCH REMOTE CONTROL WITH MASTER OFF

A six button, multifunction remote control with six available channels enabling the user to tailor the system to their needs.



500-07200 1-GANG WIRELESS SWITCH

Comes with x2 CR2032 lithium batteries.



SPECIFICATIONS

Battery Type: CR2032 Lithium Battery
Working Frequency: 433.92MHz

4 SECTION

WIRELESS LIGHTING

500-07204
2-GANG WIRELESS SWITCH
Comes with x2 CR2032 lithium batteries



500-07218
5-GANG WIRELESS SWITCH WITH MASTER OFF
Comes with x2 CR2032 lithium batteries



500-07206
2-GANG WIRELESS SWITCH WITH MASTER OFF
Comes with x2 CR2032 lithium batteries



500-07220
6-GANG WIRELESS SWITCH
Comes with x2 CR2032 lithium batteries



500-07208
3-GANG WIRELESS SWITCH
Comes with x2 CR2032 lithium batteries



500-07222
6-GANG WIRELESS SWITCH WITH MASTER OFF
Comes with x2 CR2032 lithium batteries



500-07210
3-GANG WIRELESS SWITCH WITH MASTER OFF
Comes with x2 CR2032 lithium batteries



500-07300
6-CHANNEL (12V RECEIVER)



500-07212
4-GANG WIRELESS SWITCH
Comes with x2 CR2032 lithium batteries



500-07214
4-GANG WIRELESS SWITCH WITH MASTER OFF
Comes with x2 CR2032 lithium batteries



500-07216
5-GANG WIRELESS SWITCH
Comes with x2 CR2032 lithium batteries



BLADE FUSES

500-08400
NARVA 10 AMP RED ATS BLADE FUSE
- 50 PER BOX



500-08414
NARVA 25 AMP CLEAR ATS BLADE
FUSE - 5 PER PACK



500-08402
NARVA 10 AMP RED ATS BLADE
FUSE - 5 PER PACK



500-08416
NARVA 30 AMP GREEN ATS BLADE
FUSE - 50 PER BOX



500-08404
NARVA 15 AMP BLUE ATS BLADE
FUSE - 50 PER BOX



500-08418
NARVA 30 AMP GREEN ATS BLADE
FUSE - 5 PER PACK



500-08406
NARVA 15 AMP BLUE ATS BLADE
FUSE - 5 PER PACK



500-08420
NARVA 40 AMP LIGHT BROWN ATS
BLADE FUSE - 50 PER BOX



500-08408
NARVA 20 AMP YELLOW ATS BLADE
FUSE - 50 PER BOX



500-08422
NARVA 40 AMP LIGHT BROWN ATS
BLADE FUSE - 5 PER PACK



500-08410
NARVA 20 AMP YELLOW ATS BLADE
FUSE - 5 PER PACK



500-08424
NARVA 30 AMP GREEN MAXI-BLADE
FUSE - 10 PER BOX



500-08412
NARVA 25 AMP CLEAR ATS BLADE
FUSE - 50 PER BOX



500-08426
NARVA 30 AMP GREEN MAXI-BLADE
FUSE - 1 PER PACK



4 SECTION

NARVA ELECTRICAL FITTINGS

500-08428
NARVA 40 AMP AMBER MAXI-BLADE
FUSE - 10 PER BOX



500-08442
NARVA 80 AMP CLEAR MAXI-BLADE
FUSE - 1 PER PACK



500-08430
NARVA 40 AMP AMBER MAXI-BLADE
FUSE - 1 PER PACK



500-08444
NARVA 100 AMP PURPLE MAXI-
BLADE FUSE - 10 PER BOX



500-08432
NARVA 50 AMP RED MAXI-BLADE
FUSE - 10 PER BOX



500-08446
NARVA 100 AMP PURPLE MAXI-
BLADE FUSE - 1 PER PACK



500-08434
NARVA 50 AMP RED MAXI-BLADE
FUSE - 10 PER BOX



INLINE FUSE HOLDERS

500-08448
NARVA IN-LINE STD ATS BLADE
FUSE HOLDER (30A MAX)
- 1 PER PACK



500-08436
NARVA 60 AMP BLUE MAXI-BLADE
FUSE - 10 PER BOX



500-08450
NARVA IN-LINE STD ATS BLADE
FUSE HOLDER (30A MAX)
- 10 PER BOX



500-08438
NARVA 60 AMP BLUE MAXI-BLADE
FUSE - 1 PER PACK



500-08452
NARVA IN-LINE MAXI BLADE FUSE
HOLDER (60A MAX)
- 1 PER PACK (BLISTER PAC)



500-08440
NARVA 80 AMP CLEAR MAXI-BLADE
FUSE - 10 PER BOX



500-08454
NARVA IN-LINE MAXI BLADE FUSE
HOLDER (60A MAX) - 1 PER BOX



BLADE TERMINALS

500-08456

**NARVA 6.3X0.8MM TRANS- RED
MALE BLADE TERMINAL T/S
2.5-3MM - 50 PER BOX**



500-08458

**NARVA 6.3X0.8MM TRANS-BLUE
MALE BLADE TERMINAL T/S
4MM - 50 PER BOX**



500-08460

**NARVA 6.3X0.8MM TRANS-YELLOW
MALE BLADE TERMINAL T/S
5-6MM - 50 PER BOX**



500-08462

**NARVA 6.3X0.8MM RED FLARED
MALE BLADE TERMINAL T/S
2.5-3MM - 100 PER BOX**



500-08464

**NARVA 6.3X0.8MM BLUE FLARED
MALE BLADE TERMINAL T/S
4MM - 100 PER BOX**



500-08466

**NARVA 6.3X0.8MM YELLOW FLARED
MALE BLADE TERMINAL T/S
5-6MM - 100 PER BOX**



500-08468

**NARVA 6.3X0.8MM RED FEMALE
BLADE TERMINAL T/S 2.5-3MM
- 100 PER BOX**



500-08470

**NARVA 6.3X0.8MM BLUE FEMALE
BLADE TERMINAL T/S 4MM
- 100 PER BOX**



500-08472

**NARVA 6.3X0.8MM BLUE FEMALE
BLADE TERMINAL T/S
4.8MM - 100 PER BOX**



500-08474

**NARVA 6.3X0.8MM YELLOW FEMALE
BLADE TERMINAL T/S
5-6MM - 100 PER BOX**



500-08476

**NARVA 6.3X0.8MM TRANS-RED
FEMALE BLADE TERMINAL T/S
2.5-3MM - 100 PER BOX**



500-08478

**NARVA 6.3X0.8MM RED FEMALE
BLADE TERMINAL T/S
2.5-3MM - 100 PER BOX**



500-08480

**NARVA 6.3X0.8MM TRANS-BLUE
FEMALE BLADE TERMINAL T/S
4MM - 100 PER BOX**



500-08482

**NARVA 6.3X0.8MM BLUE FEMALE
BLADE TERMINAL T/S
4MM - 100 PER BOX**



500-08484

**NARVA 6.3X0.8MM TRANS-YELLOW
FEMALE BLADE TERMINAL T/S
5-6MM - 100 PER B**



4 SECTION

NARVA ELECTRICAL FITTINGS

500-08486
NARVA 4.0MM RED MALE BULLET
TERMINAL T/S
2.5-3MM - 100 PER BOX



500-08502
NARVA 4.0MM TRANS-BLUE FEMALE
BULLET TERMINAL T/S
4MM - 100 PER BOX



500-08488
NARVA 4.0MM TRANS-RED MALE
BULLET TERMINAL T/S
2.5-3MM - 100 PER BOX



500-08504
NARVA 5.0MM YELLOW FEMALE
BULLET TERMINAL T/S
5-6MM - 100 PER BOX



500-08490
NARVA 5.0MM BLUE MALE BULLET
TERMINAL T/S
4MM - 100 PER BOX



SPLICE JOINERS

500-08506
NARVA RED BUTT SPLICE CABLE
JOINER T/S
2.5-3MM - 100 PER BOX



500-08492
NARVA 4.0MM TRANS-BLUE MALE
BULLET TERMINAL T/S
4MM - 100 PER BOX



500-08508
NARVA BLUE BUTT SPLICE CABLE
JOINER T/S
4MM - 100 PER BOX



500-08494
NARVA 5.0MM YELLOW MALE
BULLET TERMINAL T/S
5-6MM - 100 PER BOX



500-08510
NARVA YELLOW BUTT SPLICE
CABLE JOINER T/S
5-6MM - 100 PER BOX



500-08496
NARVA 4.0MM RED FEMALE BULLET
TERMINAL T/S
2.5-3MM - 100 PER BOX



RING TERMINALS

500-08512
NARVA 8.4MM RED RING TERMINAL
T/S 2.5-3MM
- 100 PER BOX



500-08498
NARVA 4.0MM TRANS-RED FEMALE
BULLET TERMINAL T/S
2.5-3MM - 100 PER BOX



500-08514
NARVA BLUE 8.4MM BLUE RING
TERMINAL T/S
4MM - 100 PER BOX



500-08500
NARVA 5.0MM BLUE FEMALE
BULLET TERMINAL T/S
4MM - 100 PER BOX



500-08516
NARVA 8.4MM YELLOW RING
TERMINAL T/S
5-6MM - 100 PER BOX



500-08518
NARVA 9.5MM YELLOW RING
TERMINAL T/S 5-6MM - 100 PER BOX



BARREL LUGS

500-08520
NARVA 10MMSQ 8MM STUD
STRAIGHT BARREL CABLE LUG
- 10 PER BOX



500-08522
NARVA 10MMSQ 10MM STUD
STRAIGHT BARREL CABLE LUG
- 10 PER BOX



500-08524
NARVA 25MMSQ 8MM STUD
STRAIGHT BARREL CABLE LUG
- 10 PER BOX



500-08526
NARVA 25MMSQ 10MM STUD
STRAIGHT BARREL CABLE LUG
- 10 PER BOX



ELECTRICAL TAPE

500-08580
NARVA 19MM PVC BLACK
INSULATION TAPE - 10 ROLLS



500-08582
NARVA 19MM PVC BLACK FLAME
RETARDANT INSULATION TAPE - 10
ROLLS



POWER INLETS & OUTLETS

500-09000
POWER INLET SOCKET 15A IN
WHITE



500-09002
POWER INLET SOCKET 15A IN
BLACK



500-09004
POWER OUTLET SOCKET 10A IN
WHITE



500-09006
POWER OUTLET SOCKET 10A IN
BLACK



500-09012
MOUNTING FLANGE
13MM IN WHITE



4 SECTION

POWER INLETS & OUTLETS

500-09014
MOUNTING FLANGE
13MM IN BLACK



500-09062
SINGLE POWER POINT DOUBLE
POLE DEEP
IN WHITE



500-09016
MOUNTING FLANGE
20MM IN WHITE



500-09064
DOUBLE POWER POINT 10A
DOUBLE POLE DEEP



500-09018
MOUNTING FLANGE
20MM IN BLACK



500-09070
ARCHITRAVE SWITCH
1 GANG WHITE



500-09050
POWER POINT SINGLE 10A
DOUBLE POLE



500-09072
ARCHITRAVE SWITCH 1
GANG BLACK



500-09052
POWER POINT DOUBLE 10A
DOUBLE POLE



500-02600
NARVA 12 PIN FLAT
TRAILER PLUG
7 pole amp rating per pole 15A
at 12V.5 pole amp rating per
pole 35A at 12V



500-09054
POWER POINT DOUBLE POLE
10A WITH DUAL USB CHARGER



500-02602
NARVA 12 PIN TRAILER SOCKET
7 pole amp rating per pole 15A
at 12V 5 pole amp rating per pole 35A
at 12V



500-09056
QUAD POWER POINT 10A
DOUBLE POLE



500-03002
FLAP TO SUIT CLIPSAL OLD
STYLE INLET



500-03032
FLAP TO SUIT CLIPSAL NEW
STYLE OUTLET

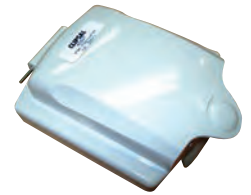

500-03020
CLIPSAL (NEW) WHITE EXTERNAL
15A POWER INLET

A flush inlet with weatherproof flap.
(Ensure the cable shroud is secured after
cable connections).



500-03050
CLIPSAL MOUNTING FLANGE
TO SUIT NEW STYLE INLET/
OUTLET



500-03021
CLIPSAL BLACK EXTERNAL 15AMP
POWER INLET



500-03052
CLIPSAL MOUNTING FLANGE TO
SUIT OLD STYLE INLET/OUTLET



500-03022
FLAP TO SUIT CLIPSAL NEW STYLE
INLET



500-03054
CLIPSAL MOUNTING FLANGE BLACK
T/S NEW STYLE INLET



500-03028
CLIPSAL (NEW) BLACK EXTERNAL 10
AMP POWER OUTLET



500-03101
CLIPSAL COVER TO SUIT
CIRCUIT BREAKER (SLIM)

An 18mm wide cover to suit single
circuit breakers (such as
500-03105)



500-03030
CLIPSAL (NEW) WHITE EXTERNAL
10A POWER OUTLET WITH
WATERPROOF FLAP



ELECTRICAL LEADS

500-03102

CLIPSAL COVER TO SUIT CIRCUIT BREAKER

Suitable for covering 36mm wide circuit breakers.



500-03200

SINGLE POWER OUTLET DOUBLE POLE 15D WHITE

Double pole power outlet single, 250V, 10A.



500-03105

CIRCUIT BREAKER (WITH EARTH LEAKAGE)

Clipsal Max 4 - combination residual current devices and miniature circuit breaker, remember to test these on a monthly basis by operating their inbuilt test button, standard slim type, non-delayed, 240V, 16A - 30mA, 1-phase +N, 6kA, 1 module wide, 50Hz.



500-03204

DOUBLE POWER OUTLET DOUBLE POLE 25D WHITE

Twin (standard) size horizontal mount power outlet with double plate, 250V, 10A.



500-03110

CLIPSAL 75 OHM COAXIAL CABLE SURFACE SOCKET

These sockets are designed to accommodate solid core conductor coaxial cables with insulation up to 5mm (diameter) for solderless connections.



500-03206

MOUNTING BLOCK WHITE

Moulded mounting block, one gang to suit all standard size accessories.



500-03120

CLIPSAL 492/32 FIXED POLARITY PLUG GREY

Flexible two-pin plugs do not require insulated pins to comply with Australian/New Zealand Standards. This is a flexible plug with two parallel pins, 10A.



500-03208

DOUBLE POLE SWITCH 30D WHITE

Conventional architrave switch, the terminals accommodate 3 x 2.5mm sq. cables. 250V 10A AC only.



500-03122

CLIPSAL 438/32 FIXED POLARITY CORD SOCKET GREY

32V Socket, 15A 2pin polar to suit 1.5mm² (ordinary duty)



500-03400

ELECTUS ANDERSON PLUG (50AMP)

A 50A, high current connector that is used in domestic and industrial applications e.g. 4WD, boating and automotive. It comes with a pair of contacts.



SPECIFICATIONS

Contact Wire Size: 6AWG

Voltage Rating: 600V (AC or DC)

Max Wire Insulation Diameter: 11mm

500-03124

402/32 FIXED POLARITY SOCKET WHITE

Front connecting surface socket with two polarized pins, 32V, 15A.



500-06562
NARVA HD 50AMP CONNECTOR
HOUSING GRY



500-06563
NARVA HD 50AMP CONNECTOR
HOUSING BLK



500-06564
NARVA HD 50AMP CONNECTOR
HOUSING RED

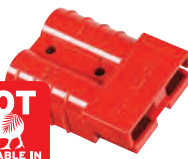

COAST HEAVY DUTY EXTENSION LEADS

Coast to Coast's new extension leads offer you a wider variety of length options so you can find the perfect sized lead for your RV or campsite, including an extra short size of 8m and extra-long size of 25m!

Our new leads are LED equipped and made from a 3 core, 1.5mm² cable with a moulded 15A plug and socket. To protect the face of the socket, they have a full 360° projecting shroud as well. All of Coast's extension leads are approved and manufactured to Australian Standards and are not suitable for use with domestic power points. Keep your site powered from any distance, with Coast to Coast's new heavy-duty extension leads!

500-03549
COAST 8M/15AMP HEAVY DUTY 240V
EXTENSION LEAD
- LED EQUIPPED



500-03551
COAST 12M/15AMP HEAVY DUTY
EXTENSION LEAD
- LED EQUIPPED



500-03553
COAST 17M/15AMP HEAVY DUTY
EXTENSION LEAD
- LED EQUIPPED



500-03555
COAST 22M/15AMP HEAVY DUTY
EXTENSION LEAD
- LED EQUIPPED



500-03557
COAST 25M/15AMP HEAVY DUTY
EXTENSION LEAD
- LED EQUIPPED



500-03602
CMS SINGLE POWER OUTLET
(WHITE)

A 10A power outlet that comes with a 20A installation coupler, and is double pole switched.



500-03610
CMS DOUBLE POWER
OUTLET (BEIGE)

Power Point Beige.



INTERCONNECTING LEAD 20A

Ordinary duty leads are manufactured from 3 core 2.5sqmm flexible cable. They are rated at 20A terminated with male and female connectors.

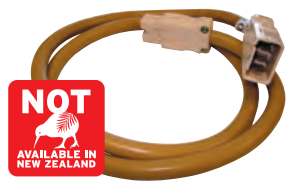

| Part Number | Description |
|-------------|---|
| 500-03700 | CMS 500mm interconnecting lead 20A beige |
| 500-03710 | CMS 1000mm interconnecting lead 20A beige |
| 500-03720 | CMS 1300mm interconnecting lead 20A beige |
| 500-03730 | CMS 1500mm interconnecting lead 20A beige |
| 500-03740 | CMS 1700mm interconnecting lead 20A beige |
| 500-03750 | CMS 2000mm interconnecting lead 20A beige |
| 500-03760 | CMS 2300mm interconnecting lead 20A beige |
| 500-03770 | CMS 2500mm interconnecting lead 20A beige |
| 500-03790 | CMS 2700mm interconnecting lead 20A beige |
| 500-03800 | CMS 3000mm interconnecting lead 20A beige |
| 500-03810 | CMS 3200mm interconnecting lead 20A beige |
| 500-03820 | CMS 3300mm interconnecting lead 20A beige |
| 500-03830 | CMS 3500mm interconnecting lead 20A beige |
| 500-03840 | CMS 3800mm interconnecting lead 20A beige |
| 500-03850 | CMS 4000mm interconnecting lead 20A beige |
| 500-03860 | CMS 4200mm interconnecting lead 20A beige |
| 500-03870 | CMS 4500mm interconnecting lead 20A beige |
| 500-03880 | CMS 4700mm interconnecting lead 20A beige |
| 500-03890 | CMS 5000mm interconnecting lead 20A beige |
| 500-03910 | CMS 5500mm interconnecting lead 20A beige |
| 500-03920 | CMS 5700mm interconnecting lead 20A beige |
| 500-03940 | CMS 6300mm interconnecting lead 20A beige |
| 500-03950 | CMS 6500mm interconnecting lead 20A beige |
| 500-03960 | CMS 6800mm interconnecting lead 20A beige |

CIRCUIT BREAKER CONNECTING LEAD 20A BEIGE



| Part Number | Description |
|-------------|--|
| 500-04000 | CMS 1000mm Circuit breaker connecting lead 20A beige |
| 500-04010 | CMS 2000mm Circuit breaker connecting lead 20A beige |
| 500-04050 | CMS 3500mm Circuit breaker connecting lead 20A beige |
| 500-04070 | CMS 4400mm Circuit breaker connecting lead 20A beige |
| 500-04100 | CMS 6300mm Circuit breaker connecting lead 20A beige |

500-04150 CMS CIRCUIT BREAKER LOOM ASSY W/H REMOTE EARTH WIRE

The CMS Circuit Breaker with Loom Assembly is a protective device that combines two functions, it acts as a residual current device and as a circuit breaker. It comes with a remote earth wire and features CMS' soft-wire interconnecting leads for a fast and simple installation.

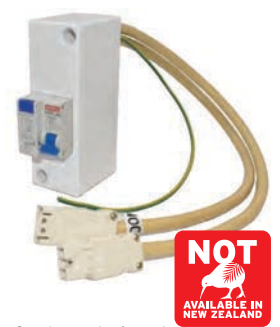

- > 240V
- > 16A-30mA
- > 4.5kA
- > SAA120741EA AS/NZs61009.1

500-04202 CMS MOUNTING BLOCK (WHITE)

Mounting block for power points and switch plate.

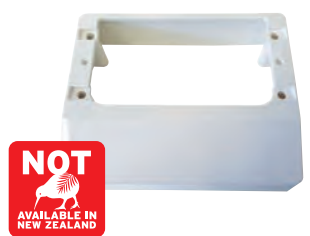

500-04210

CMS SINGLE SWITCH PLATE

Single switch plate, beige only.
(Extra low voltage only eg 12V,
Not for 240V)



500-04220

CMS DOUBLE SWITCH PLATE

Double switch plate, beige only.
(Extra low voltage only eg 12V,
Not for 240V)



500-04230

CMS TRIPLE SWITCH PLATE

Triple switch plate, beige only.
(Extra low voltage only eg 12V,
Not for 240V)



500-04250

CMS TV ANTENNA OUTLET BEIGE

Connects your TV to the aerial on
your RV's roof. Fits into the wall of
your RV.



500-04254

CMS TV ANTENNA OUTLET WHITE



500-04262

CMS 1-IN 2-OUT DOUBLE ADAPTOR (CLEAR)

J Series



500-04280

CMS MOUNTING SHROUD

CMS mounting shroud for outlets and
switch plates (beige).



500-04282

CMS MOUNTING SHROUD

CMS mounting shroud for outlets and
switch plates (black).



500-04284

CMS MOUNTING SHROUD

CMS mounting shroud for outlets and
switch plates (white).



500-04300

CMS 2-WAY 10A SWITCH

250V 2-way with looping terminal
(without indicator).



500-04310

CMS 10A DOUBLE POLE SWITCH SOCKET

Suitable for use with CMS
interconnecting leads only, direct
connection.

Recess Required: 61mm

250V, 50Hz, 20Amp installation coupler



500-04312

CMS 15A POWER INLET

Suitable for use with CMS interconnecting
leads only, direct connection.

Recess Required: 61mm

250V, 50Hz, 20A installation coupler.



500-04313

CMS 15AMP PLUG POWER INLET BLACK



10 AMP - 15 AMP ADAPTORS

500-04314

CMS TWIN DOUBLE POLE AUTO SOCKET

A 20A installation coupler with a 10A socket outlet. (250V, 50Hz)



500-04316

CMS 15AMP SINGLE 15A AUTO SWITCH INLET BLACK WITH RCD SWITCH



500-04318

CMS 15AMP SINGLE 15A AUTOS WITCH INLET WHITE WITH RCD SWITCH



500-04320

CMS 3 WAY ADAPTOR (BEIGE) 20A, 240V, IP4X



CMS POWER OUTLETS

240v CMS Electrical products are not your usual fittings as they feature a soft-wire install with interconnecting leads instead of the hard-wire install of standard fittings. The advantage to this is that it is fast and simple to install or un-install as it is just a coupling connection to a lead rather than hard-wiring actual wire to connect the fitting.

500-04400

DOUBLE NATURAL - WHITE



500-04402

SINGLE N/W + DUAL 4A USB W/12VDC TERMINAL



15AMP TO 10 AMP ADAPTORS

500-04504

ELECTUS PORTABLE RCD WITH 15A TO 10A MAINS PLUG CONVERSION

Featuring a 10A circuit breaker/RCD for overload protection, this portable RCD is ideal if you have a device with a 15A mains plug but no 15A power outlet available.



SPECIFICATIONS

Voltage: 240V AC, 50Hz
Max Load: 2400W, 10A
Rated Residual Current: 30mA
Dimensions: 180H x 135D x 124W (mm)

500-04501

AMP-FIBIAN RV-02MAX 15AMP TO 10AMP ADAPTER

The Ampfibian adaptor allows for a 15A load (e.g. that of a caravan) to connect to a standard household power point (10A). With upgraded features such as being waterproof to IP55, being able to accept leads up to 12mm in diameter and with a new H-Class rating, the Ampfibian is the safe option to connect to domestic outlets. It will automatically trip at 10A if the power outlet becomes overloaded. Designed and made in Australia, the Ampfibian comes with RCD and overload protection, as well as a two year warranty.



500-04503

AMP-FIBIAN MINI 15AMP TO 10AMP ADAPTER

Suitable for use where a waterproof rating is not essential, the Ampfibian Mini has all the same features as its big brother but with an IP33 rating. It has all the essentials such as RCD and overload protection, and a 10A circuit breaker which prevents overloading by cutting the power if it exceeds 10A (2400W). Designed and made in Australia, it comes with a two year manufacturer's warranty.



SPECIFICATIONS

Class: L - suitable for DIY/Handyman jobs
RCD: 30mA, 10kA fault current
Power: 220-240VAC, 50-60Hz

500-04506

AMP-FIBIAN RV-PLUS 15AMP TO 10AMP ADAPTER WITH OVERLOAD

The Ampfibian RV Plus is the perfect power adapter for caravan/RV owners. Compact for travel, and weatherproof for outdoor use, it lets 15A devices connect legally to 10A power points and includes fast acting earth leakage safety protection.



Features

- > It is water resistant to IP-55 (jets of water from all directions) and made from impact resistant plastic.
- > Works with ordinary and heavy-duty caravan leads up to 12mm diameter.
- > 240V 10A 2400W circuit breaker
- > R.C.D. for personal protection
- > Padlock attachment point locks lid
- > Power indicator light in socket
- > Certified to comply with Australian Standards AS/NZS-3190 & AS/NZS-3001
- > Two year warranty
- > Designed & Made in Australia)

500-04508

AMP-FIBIAN WEATHERPROOF CARAVAN SURGE PROTECTOR

Australia's only portable 15A caravan surge protector! Protects your inverter and electronic gear from power spikes and surges. Rated at 15 Amps, with a 1000 Joule power absorption rating and four integrated fuses, this touch little product protects your expensive investment.



Features

- > Red warning light tells you if the power point is incorrectly wired before plugging in
- > Tough weatherproof housing seals the connection and allows you to see the indicator lights.
- > Two spring-loaded cleats stop the caravan lead pulling out
- > Flip-up hook lets you hang it off the ground
- > 15 Amp plug goes into the site's power supply or generator before your caravan.
- > Compatible with Ampfibian 15A to 10A Power Adaptors
- > Meets Australian and New Zealand electrical standards (AS/NZS 3120:2011)

SPECIFICATIONS

240V / 50Hz / 15A / 3600W
1000 Joule protection
Meets AS/NZ 3120:2011
IP55 Weatherproof

500-04509

AMP-FIBIAN WEATHERPROOF CARAVAN SURGE PROTECTOR REPLACEMENT CARTRIDGE



500-04520

POD 15 AMP TO 10 AMP ADAPTER

Designed in South Australia, the POD is great for the RV and tradie industry. Its yellow and compact housing, makes it a portable powerhouse resulting in an efficient 15Amp to 10Amp power adapter. It has water ingress protection (IP55) and has been tested to comply with AS/NZ3190:2011. Safety comes first with the POD, it also features RCD overload protection as well as an inbuilt circuit breaker for current overload protection. Other handy features include a clear lid for easy inspection, a cord clamp to ensure your domestic supply cannot pull free and a convenient hook for hanging when in use. Comes with a one year manufacturer's warranty.



SPECIFICATIONS

Max loading: 10A
Suits ordinary duty 15A leads & features a 1.5m lead

NARVA ACCESSORY SOCKETS

500-05070

SURFACE MOUNT ACCESSORY SOCKET

Ideally suited for RV and marine type applications, the socket has a dustproof rubber cover and a plastic housing. It is suitable for interior or exterior installations, however in the case of an exterior fitment, the socket opening should point towards the ground. Comes in a single blister pack.



SPECIFICATIONS

Amperage Rating: 20A at 12V, 10A at 24V
Dimensions (mm): 80 x 50

NARVA ACCESSORY SOCKETS

500-05072 NARVA SURFACE MOUNT ACCESSORY (BLACK)

Features dustproof cover and heavy-duty construction. Can be installed with or without the mounting panel. The fitting mechanism allows installation into interior or exterior panels including steel and aluminium. Can be installed with or without the mounting panel.



Moulded housing allows fitment to interior or exterior panels for easy installation.

SPECIFICATIONS

Rating: 20A at 12V, 10A at 24V
Dimensions (mm): 80 x 55

500-05304 ACCESSORY SOCKET H/D

SPECIFICATIONS

Amperage Rating: 20A at 12V, 10A at 24V
Mounting Opening: 29mm diameter



500-05312 ACCESSORY SOCKET DUAL USB H/D

SPECIFICATIONS

Output: 5V, 2.5A
Mounting Opening: 29mm diameter



500-05318 ACCESSORY SOCKET TWIN ACCESSORY/ DUAL USB H/D

SPECIFICATIONS

USB Output: 5V, 2.5A
Mounting Opening: 29mm diameter



500-05322 ACCESSORY SOCKET SURFACE MOUNT DUAL USB H/D

SPECIFICATIONS

USB Output: 5V, 2.5A



500-05324 ACCESSORY SOCKET SURFACE BLACK MOUNT TWIN SOCKETS H/D



SPECIFICATIONS

Amperage Rating: 20A at 12V, 10A at 24V per socket

500-05325 ACCESSORY SOCKET WHITE SURFACE MOUNT TWIN SOCKETS H/D



SPECIFICATIONS

Amperage Rating: 20A at 12V, 10A at 24V per socket

500-05332 ACCESSORY SOCKET SURFACE MOUNT TWIN ACCESSORY / DUAL USB H/D



SPECIFICATIONS

Accessory Socket: 20A at 12V, 10A at 24V
USB Output: 5V, 2.5A
Mounting Opening: 9mm diameter per socket

500-05334 ACCESSORY SOCKET WHITE SURFACE MOUNT TWIN ACCESSORY / DUAL USB H/D



SPECIFICATIONS

Accessory Socket: 20A at 12V, 10A at 24V
USB Output: 5V, 2.5A

500-05340 ACCESSORY SOCKET H/D AND 12/24V DC L.E.D VOLT METER

Easy to read L.E.D Volt Meter displays accurate battery voltage level.



SPECIFICATIONS

Accessory Socket: 20A at 12V, 10A at 24V
Volt Meter Range: 6-33V DC

SPHERE TWIN CELL RANGE

500-06250

200W SOLAR PANELS FEATURING TWIN CELL TECHNOLOGY

Sphere Twin Cell Solar Technology is the future of solar power generation for the Caravanning and RV Market.

Researched and developed in Australia, Sphere Twin Cell Technology is an innovative solution to the common issue of partial shading that affects caravan and RV solar power applications. Partial shading caused by roof top mounted accessories such as air conditioners, roof vents and satellites can result in severe bottlenecks for conventional solar panels. When even a small section of a traditional panel is covered by shade, a blockage is created that drastically reduces overall output.

Sphere Twin Cell Technology helps reduce the impact of partial shading by allowing a single large solar panel to operate as if it were two smaller panels with isolated circuit paths. This unique parallel design allows each side of the panel to function independently from the other. When one half of a panel is covered by shade, the other will still perform at full capacity. Where partial shading will have already stopped traditional mono-crystalline panels from providing vital power, Sphere Solar Panels with Twin Cell Technology will keep on charging.

Sphere Solar Panels with Twin Cell Technology continue producing 100-125w when shaded up to 50%.



500-06252

250W SOLAR PANELS FEATURING TWIN CELL TECHNOLOGY

FEATURES

- > Sphere Twin Cell Solar Technology for improved performance in partial shade.
- > Improved cell efficiency enabling 200W from a 180W footprint.
- > By-passed diodes to improve reliability and further minimize power drops caused by shade.
- > An anodized aluminium frame to withstand rust with pre drilled mounting holes for a versatile range of applications.
- > Antireflective, high transparency tempered glass for durability
- > IP65 rated junction box provides complete protection against dust and water.



| SPECIFICATIONS | Part number | 500-06250 | 500-06252 |
|----------------------------------|---------------------------|---|--------------------|
| Electricity Performance | Standard Test Conditions | 1000W/M2,1.5AM,25 | |
| | Peak Power Output (W) | 200 W | 250W |
| | Power Output Tolerance(%) | 3% | 3% |
| | Maximum Power Voltage (V) | 20.6 | 20.61 |
| | Maximum Power Current (A) | 9.71 | 12.13 |
| | Short Circuit Current (A) | 9.85 | 12.35 |
| | Open Circuit Voltage (V) | 24.1 | 24.1 |
| | Maximum System Voltage | 1000V/DC | 1000V/DC |
| Mechanical Performance | Junction Box Type | 0.9 m 4mm 2 solar cable fitted with MC 4 IP65 | |
| | Number of Cells | 4*18 72 72pcs | 4*18 72pcs |
| | Module Size (mm) | 670*1480*35*30*1.2 | 670*1850*35*30*1.2 |
| | Module Net Weight | 11 KG | 14KG |
| Temperature Coefficient | Working Temperature | -40 ~ 85 °C | |
| | Power TK | -0.45%/0.45%/°C | -0.45%/°C |
| | Open Circuit Voltage T | -0.3 3%/ °C | -0.33%/°C |
| | Short Circuit Current T | 0.045%/ | 0.045%/°C |
| | Test temperature | 25±2 °C | 25±2°C |
| Guarantee of power output | <10 Years | >90% | |
| | <25 Years | >80% | |
| | Material Warranty | 12 Months | |

Twin Cell Technology vs Standard Cell Panels

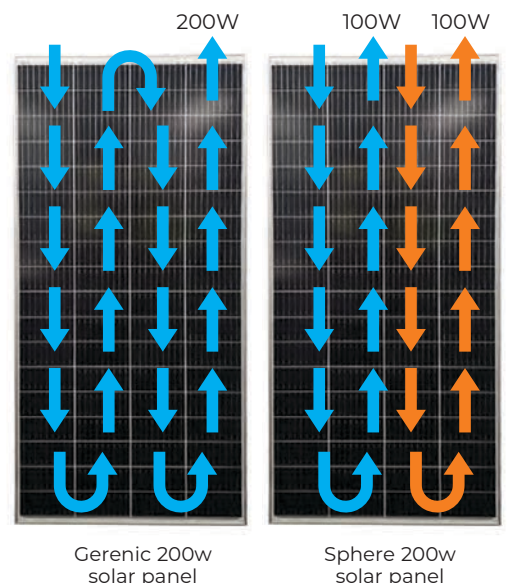

500-06172
SOLAR PANEL UNIVERSAL MOUNT KIT

Sold as a kit containing: x4 corner mounts (top and bottom), x2 centre mounts (top and bottom), x20 locking screws and x40 height adjusting screws (x20 large for a 35mm frame and x20 small for a 40mm frame).



SPHERE SOLAR CHARGE REGULATORS

Solar power is one of the most convenient and portable ways to power your campsite! Now, you can take control of your power with Sphere's new Solar Charge Regulators! Direct the flow of your solar power where you need it most, with a simple and user-friendly design and built-in protection against overcharges.

500-06220
SPHERE PWM 12V/24V 40A SOLAR CHARGE CONTROLLER

The Sphere PWM Solar Charge Controller adopts an upgraded 3-stage PWM charging algorithm, which applies an equalizing charge to the battery periodically to prevent it from non-equalization and sulfuration, extending the battery's service life (with the exception of GEL and lithium batteries). Boasting an industrial grade design, the Solar Charge Controller is able to function in various tough conditions with TVS lighting protection.



- > Advanced 3-stage PWM charging algorithm
- > Overload, overcharge, and over-discharge protection
- > Dot Matrix Graphic LCD Screen
- > Multiple charging options for various battery types
- > Automatically recognises 12V/24V system voltages
- > User-friendly design with intuitive operations

SPECIFICATIONS

Rated Current: 40A
Max PV Input: 600W/12V
Max. Solar Energy Input Voltage: < 55V
Max. Voltage at Battery End: < 34V

500-06222
SPHERE MPPT 12V/24V 40A SOLAR CHARGE CONTROLLER

With advanced dual-peak or multi-peak tracking technology, the Sphere MPPT Controller is still able to accurately track the maximum power point even when the solar panel is shadowed or partly fails. The controller is equipped with an LCD screen which can display abnormality information to help users to quickly identify system faults.



- > Advanced dual-peak or multi-peak technology
- > Built-in maximum power point tracking algorithm
- > MPPT tracking efficiency up to 99.9% with advanced conversion efficiency to as high as 98%
- > Multiple charging options for various battery types
- > Automatic recognition of battery voltage
- > LED fault indicators and an LCD Screen
- > Built-in over-heating protection mechanism

SPECIFICATIONS

Rated Charging Current: 40A
Max PV Input: 550W/12V
System Voltage: 12V/24V Auto
Max. Solar input Voltage: 100, 90V

SPHERE TYRE INFLATORS

500-06300
SPHERE SWIFT TYRE INFLATOR 28L/MIN

Ideal for 4x4s, SUVs, caravans and motorhomes. Inflates 4x4 tyre in 6 minutes and a car tyre in just 2.5 minutes. Simple set up - just rotate dial to set pressure. Back lit digital display makes it easy to set your desire pressure. Automatically stops when the pressure is reached LED light built in for ease of use at night. Long cables to reach tyres all around the vehicle. Comes with three piece adaptor kit.



SPECIFICATIONS

Product Dimensions (mm): H168 x W238 x D123
Weight (kg): 2.026
Voltage: 12V DC
Watts: 180W

500-06302

SPHERE RAPID FLOW TYRE INFLATOR 33L/MIN

Ideal for 4x4s, SUVs, caravans and motorhomes. Powerful inflation from a 12V socket - 4x4 tyre inflates in 5 mins, car tyre in 2 mins. Back lit digital display makes it easy to set your desire pressure Automatically stops when the pressure is reached LED light built in for ease of use at night Long cables to reach tyres all around the vehicle. Comes with three piece adaptor kit.



SPECIFICATIONS

Product Dimensions (mm): H172 x W260 x D128

Weight (kg): 2.696

Voltage: 12V DC

Watts: 180W

500-06512

NARVA TRAILER PLUG 7 PIN LARGE ROUND PLASTIC BLISTER PACK



500-06514

NARVA TRAILER PLUG 7 PIN LARGE ROUND PLASTIC BLISTER PACK



TRAILER PLUGS

500-06306

NARVA H/DTY 5MT ACCESSORY EXTENSION LEAD



500-06520

NARVA TRAILER PLUG 7PIN FLAT BLISTER PACK



500-06500

NARVA TRAILER PLUG 6 PIN SMALL ROUND PLASTIC BLISTER



500-06522

NARVA CAR SOCKET 7 PIN FLAT BLISTER PACK



500-06504

NARVA TRAILER PLUG 7 PIN SMALL ROUND PLASTIC BLISTER PACK



500-06532

NARVA TRAILER ADAPTOR 7 PIN ROUND CAR TO 6 PIN ROUND VAN



500-06506

NARVA CAR SOCKET 7 PIN SMALL ROUND PLASTIC BLISTER PACK



500-06536

NARVA TRAILER ADAPTOR 7 PIN ROUND CAR TO 7 PIN FLAT VAN



4 SECTION

TRAILER EQUIPMENT

500-06540
NARVA TRAILER ADAPTOR
7 PIN FLAT CAR TO 7 PIN
ROUND VAN



500-02600
NARVA 12 PIN FLAT
TRAILER PLUG
 7 pole amp rating per pole
 15A at 12V
 5 pole amp rating per pole
 35A at 12V



500-06544
NARVA TRAILER ADAPTOR
7 PIN LARGE ROUND CAR TO 7
PIN FLAT VAN



500-02602
NARVA 12 PIN TRAILER SOCKET
 7 pole amp rating per pole 15A at 12V
 5 pole amp rating per pole 35A at 12V



500-06548
NARVA TRAILER ADAPTOR
7 PIN FLAT CAR TO 7 PIN
LARGE ROUND VAN



500-90004N
ELECTREX 10M CARAVAN
SUPPLY LEAD STANDARD
 A supply lead for caravans and motorhomes allowing for connection to camp site power supply posts. Comes complete with a plug, connector and a strain relief dog bone.



500-06552
NARVA TRAILER ADAPTOR
7 PIN LARGE ROUND CAR TO 7
PIN SMALL ROUND VAN



500-90006N
ELECTREX 10M ANGLED
CARAVAN SUPPLY LEAD
 A supply lead for caravans and motorhomes allowing for connection to camp site power supply posts. Comes complete with a plug, angled connector and a strain relief dog bone.



500-06560
NARVA TRAILER ADAPTOR
7 PIN SMALL ROUND CAR TO 7
PIN LARGE RND VAN



500-90008N
ELECTREX CARAVAN
SUPPLY ADAPTOR
 Allows you to provide power to your caravan or motorhome from a domestic power point. The Caravan Supply Adaptor has a 10A MCB to protect the domestic power supply.



500-06562
NARVA HEAVY DUTY
50AMP CONNECTOR
HOUSING

Has an impact resistant polycarbonate housing and silver plated solid copper terminals.



500-90010N
ELECTREX 10M CARAVAN SUPPLY
LEAD WITH C/W
J/BOX
 Power cord locker with a 10m fixed supply lead.



SPECIFICATIONS
 Amperage rating: 50A
 Suits cable size: 8mm²
 Operating temperature: -20°C to 105°C

500-90012N
ELECTREX EXTERNAL INLET PLUG

A 240V blue surface mounting IP67 inlet. Rating: 16A



SPECIFICATIONS

Pins: 2P + E

Earth Position: 6H

500-90014N
ELECTREX PLUG-FEMALE

Optima Series IP67 connector. It is a blue 240V connector rated at 16A.



SPECIFICATIONS

Pins: 2P + E

Earth Position: 6H Ins. Perforation

500-90016N
ELECTREX PLUG-MALE

An IP44, blue, 240V plug, rated at 16A.



SPECIFICATIONS

Pins: 2P + E

Earth Position: 6H Ins. Perforation

500-90022N
ELECTREX FEMALE PLUG 90 DEGREE (FOR FLUSH MOUNT INLET)

Optima Series IP44 connector. It is a blue 240V connector rated at 16A.



SPECIFICATIONS

Pins: 2P + E

Earth Position: 6H (Right Angle)

TYCAB AUTO AND MARINE CABLE

Tycab Australia Automotive cable leading the way...and streets ahead!

Tycab Australia is the major manufacturer of automotive cable in Australia. Tycab has been at the forefront of manufacturing automotive aftermarket and OEM cables for over 30 years. All Tycab cable are made from the highest quality Oxygen Free Plain Copper Wire and is RoHS compliant. Tycab Australia automotive cable is renowned for reliability, quality and flexibility.

Single Core

LOW TENSION PRIMARY WIRING

Application: General Purpose Automotive Wiring

Conductor: OXYGEN FREE Plain Copper Wire to AS/NZS 1125

Insulation: V90 PVC Insulated to AS/NZS 3808

Colours: Black, Red,

Packs: 30, 100 metres



| Part Number | Description |
|-------------|---|
| 500-08100 | AUTO Cable 30m Reel - 3MM BLACK Single-Core. ASC11603-BK-30 |
| 500-08102 | AUTO Cable 100m Reel - 3MM BLACK Single-Core. ASC11603-BK-100 |
| 500-08104 | AUTO Cable 30m Reel - 3MM RED Single-Core. ASC11603-RD-30 |
| 500-08106 | AUTO Cable 100m Reel - 3MM RED Single-Core. ASC11603-RD-100 |
| 500-08108 | AUTO Cable 30m Reel - 4MM BLACK Single-Core. ASC12603-BK-30 |
| 500-08110 | AUTO Cable 100m Reel - 4MM BLACK Single-Core. ASC12603-BK-100 |
| 500-08112 | AUTO Cable 30m Reel - 4MM RED Single-Core. ASC12603-RD-30 |
| 500-08114 | AUTO Cable 100m Reel - 4MM RED Single-Core. ASC12603-RD-100 |
| 500-08116 | AUTO Cable 30m Reel - 6MM BLACK Single-Core. ASC16503-BK-30 |
| 500-08118 | AUTO Cable 100m Reel - 6MM BLACK Single-Core. ASC16503-BK-100 |
| 500-08120 | AUTO Cable 30m Reel - 6MM RED Single-Core. ASC16503-RD-30 |
| 500-08122 | AUTO Cable 100m Reel - 6MM RED Single-Core. ASC16503-RD-100 |
| 500-08100 | AUTO Cable 30m Reel - 3MM BLACK Single-Core. ASC11603-BK-30 |
| 500-08102 | AUTO Cable 100m Reel - 3MM BLACK Single-Core. ASC11603-BK-100 |
| 500-08104 | AUTO Cable 30m Reel - 3MM RED Single-Core. ASC11603-RD-30 |
| 500-08106 | AUTO Cable 100m Reel - 3MM RED Single-Core. ASC11603-RD-100 |
| 500-08108 | AUTO Cable 30m Reel - 4MM BLACK Single-Core. ASC12603-BK-30 |
| 500-08110 | AUTO Cable 100m Reel - 4MM BLACK Single-Core. ASC12603-BK-100 |
| 500-08112 | AUTO Cable 30m Reel - 4MM RED Single-Core. ASC12603-RD-30 |
| 500-08114 | AUTO Cable 100m Reel - 4MM RED Single-Core. ASC12603-RD-100 |
| 500-08116 | AUTO Cable 30m Reel - 6MM BLACK Single-Core. ASC16503-BK-30 |
| 500-08118 | AUTO Cable 100m Reel - 6MM BLACK Single-Core. ASC16503-BK-100 |
| 500-08120 | AUTO Cable 30m Reel - 6MM RED Single-Core. ASC16503-RD-30 |
| 500-08122 | AUTO Cable 100m Reel - 6MM RED Single-Core. ASC16503-RD-100 |

4 SECTION CABLES

| MM Industry Equiv. | NZ equiv. | Strand No. / Size | Nominal Area (mm ²) | AMP Rating at 30°C | Insulation Thickness (mm) | Electrical Resistance at 20°C (ohm/km) | Nominal O.D. (mm) | Mass (kg/100m) |
|--------------------|-----------|-------------------|---------------------------------|--------------------|---------------------------|--|-------------------|----------------|
| 3 | 150 | 14/0.32 | 1.13 | 20 | 0.4 | 16.5 | 2.2 | 1.4 |
| 4 | 152 | 23/0.32 | 1.84 | 28 | 0.4 | 10.1 | 2.6 | 2.1 |
| 6 | 156 | 57/0.32 | 4.59 | 48 | 0.6 | 4.1 | 4 | 5.3 |

* MM - is an industry term that identifies cable size and is not CONDUCTOR CROSS SECTION AREA

BATTERY / STARTER

SPECIFICATIONS

Applications: Battery and Starter Cable

Conductor: OXYGEN FREE Plain Copper Wire to AS/NZS 1125

Insulation: V90 PVC to AS/NZS 3808

Sheath^o Colours: Red or Black

Packs: 30, 100 metres



| Part Number | Description |
|-------------|--|
| 500-08130 | AUTO Cable 30m Reel - 8 B&S BLACK Battery/Starter. ABC111203-BK-30 |
| 500-08132 | AUTO Cable 100m Reel - 8 B&S BLACK Battery/Starter. ABC111203-BK-100 |
| 500-08134 | AUTO Cable 30m Reel - 8 B&S RED Battery/Starter. ABC111203-RD-30 |
| 500-08136 | AUTO Cable 100m Reel - 8 B&S RED Battery/Starter. ABC111203-RD-100 |
| 500-08138 | AUTO Cable 30m Reel - 4 B&S BLACK Battery/Starter. ABC128703-BK-30 |
| 500-08140 | AUTO Cable 100m Reel - 4 B&S BLACK Battery/Starter. ABC128703-BK-100 |
| 500-08142 | AUTO Cable 30m Reel - 4 B&S RED Battery/Starter. ABC128703-RD-30 |
| 500-08144 | AUTO Cable 100m Reel - 4 B&S RED Battery/Starter. ABC128703-RD-100 |
| 500-08130 | AUTO Cable 30m Reel - 8 B&S BLACK Battery/Starter. ABC111203-BK-30 |
| 500-08132 | AUTO Cable 100m Reel - 8 B&S BLACK Battery/Starter. ABC111203-BK-100 |
| 500-08134 | AUTO Cable 30m Reel - 8 B&S RED Battery/Starter. ABC111203-RD-30 |
| 500-08136 | AUTO Cable 100m Reel - 8 B&S RED Battery/Starter. ABC111203-RD-100 |
| 500-08138 | AUTO Cable 30m Reel - 4 B&S BLACK Battery/Starter. ABC128703-BK-30 |

| Part Number | Description |
|-------------|--|
| 500-08140 | AUTO Cable 100m Reel - 4 B&S BLACK Battery/Starter. ABC128703-BK-100 |
| 500-08142 | AUTO Cable 30m Reel - 4 B&S RED Battery/Starter. ABC128703-RD-30 |
| 500-08144 | AUTO Cable 100m Reel - 4 B&S RED Battery/Starter. ABC128703-RD-100 |

| Nearest B & S | NZ equiv. | Strand No. / Size | Nominal Area (mm ²) | AMP Rating at 30°C | Insulation Thickness (mm) | Electrical Resistance at 20°C (ohm/km) | Nominal O.D. (mm) | Mass (kg/100m) |
|---------------|-----------|-------------------|---------------------------------|--------------------|---------------------------|--|-------------------|----------------|
| 8 | 158 | 96/0.32 | 7.71 | 74 | 0.9 | 2.4 | 5.5 | 9.3 |
| 4 | | 252/0.32 | 20.26 | 135 | 1.1 | 0.9 | 8.3 | 22.4 |

FIGURE 8 PARALLEL WEBBED SPEAKER

SPECIFICATIONS

PVC INSULATED

Applications: Hook-up, Speaker Connection

Conductor: OXYGEN FREE Plain Copper Wire to AS/NZS 1125

Insulation: V90 PVC to AS/NZS 3808

Colours: Red with a Black stripe

Packs: 30, 100 metres



| Part Number | Description |
|-------------|--|
| 500-08150 | AUTO Cable 30m Reel - 3MM RED & BLACK Figure 8. AFC21603-RDBK-30 |
| 500-08152 | AUTO Cable 100m Reel - 3MM RED & BLACK Figure 8. AFC21603-RDBK-100 |
| 500-08154 | AUTO Cable 30m Reel - 4MM RED & BLACK Figure 8. AFC22603-RDBK-30 |
| 500-08155 | AUTO Cable 100m Reel - 4MM RED & BLACK Figure 8. AFC22603-RDBK-100 |

| MM Industry Equiv. | NZ equiv. | No. of Cores | Strand No. / Size | Nominal Area (mm ²) | AMP Rating at 30°C | Insulation Thickness (mm) | Electrical Resistance at 20°C (ohm/km) | Nominal O.D. (mm) | Mass (kg/100m) |
|--------------------|-----------|--------------|-------------------|---------------------------------|--------------------|---------------------------|--|-------------------|----------------|
| 3 | 151 | 2 | 14/0.32 | 1.13 | 16 | 0.6 | 16.5 | 2.6 x 5.9 | 3.2 |
| 4 | 153 | 2 | 23/0.32 | 1.84 | 22 | 0.6 | 10.1 | 3.1 x 6.7 | 4.9 |

TWIN SHEATH TWO CORE FLAT

SPECIFICATIONS

V90 PVC INSULATED AND SHEATHED

Applications: Trailer Wiring

Conductor: OXYGEN FREE Plain Copper Wire to AS/NZS 1125

Insulation: V90 PVC to AS/NZS 3808

Colours: Red, Black

Packs: 30, 100 metres



| Part Number | Description |
|------------------|---|
| 500-08160 | AUTO Cable 30m Reel - 4MM BLACK Twin Sheath 2-CORE Flat. AWC22603-BK-30 |
| 500-08162 | AUTO Cable 100m Reel - 4MM BLACK Twin Sheath 2-CORE Flat. AWC22603-BK-100 |
| 500-08164 | AUTO Cable 30m Reel - 5MM BLACK Twin Sheath 2-CORE Flat. AWC24103-BK-30 |
| 500-08166 | AUTO Cable 100m Reel - 5MM BLACK Twin Sheath 2-CORE Flat. AWC24103-BK-100 |
| 500-08168 | AUTO Cable 30m Reel - 6MM BLACK Twin Sheath 2-CORE Flat. AWC26503-BK-30 |
| 500-08170 | AUTO Cable 100m Reel - 6MM BLACK Twin Sheath 2-CORE Flat. AWC26503-BK-30 |

| MM Industry Equiv. | No. of Cores | Strand No. / Size | Nominal Area (mm ²) | AMP Rating at 30°C | Insulation Thickness (mm) | Sheath Thickness (mm) | Electrical Resistance at 20°C (ohm/km) | Nominal O.D. (mm) | Mass (kg/100m) |
|--------------------|--------------|-------------------|---------------------------------|--------------------|---------------------------|-----------------------|--|-------------------|----------------|
| 4 | 2 | 23/0.32 | 1.84 | 22 | 0.4 | 0.6 | 10.1 | 3.8 x 6.3 | 6.1 |
| 5 | 2 | 36/0.32 | 2.9 | 29 | 0.4 | 0.7 | 6.4 | 4.5 x 7.4 | 8.8 |
| 6 | 2 | 57/0.32 | 4.59 | 38 | 0.6 | 0.8 | 4.1 | 5.7 x 9.6 | 14 |

TWIN SHEATH BATTERY

SPECIFICATIONS

Applications: Battery Feeds, Charges, Winches, Power & Solar Generators

Conductor: OXYGEN FREE Plain Copper Wire to AS/NZS 1125

Insulation: V90 PVC to AS/NZS 3808

Core Colours: Red, Black

Sheath: V90 PVC to AS/NZS 3808

Sheath Colours: Black / Red

Packs: 30, 50, 100 metres



| Part Number | Description |
|------------------|--|
| 500-08172 | AUTO Cable 30m Reel - 8B&S BLACK & RED Twin Sheath 2-CORE Flat. AWC296032-BKRD-30 |
| 500-08174 | AUTO Cable 50m Reel - 8B&S BLACK & RED Twin Sheath 2-CORE Flat. AWC296032-BKRD-50 |
| 500-08176 | AUTO Cable 100m Reel - 8B&S BLACK & RED Twin Sheath 2-CORE Flat. AWC296032-BKRD-100 |
| 500-08178 | AUTO Cable 30m Reel - 4B&S BLACK & RED Twin Sheath 2-CORE Flat. AWC2252032-BKRD-30 |
| 500-08180 | AUTO Cable 50m Reel - 4B&S BLACK & RED Twin Sheath 2-CORE Flat. AWC2252032-BKRD-50 |
| 500-08182 | AUTO Cable 100m Reel - 4B&S BLACK & RED Twin Sheath 2-CORE Flat. AWC2252032-BKRD-100 |

| Nearst B & S | No. of Cores | Strand No. / Size | Nominal Area (mm ²) | AMP Rating at 30°C | Insulation Thickness (mm) | Sheath Thickness (mm) | Electrical Resistance at 20°C (ohm/km) | Nominal O.D. (mm) | Mass (kg/100m) |
|--------------|--------------|-------------------|---------------------------------|--------------------|---------------------------|-----------------------|--|-------------------|----------------|
| 8 | 2 | 96/0.32 | 7.71 | 59.2 | 0.9 | 0.8 | 2.4 | 7.1 x 12.5 | 22 |
| 4 | 2 | 252/0.32 | 20.26 | 108 | 1.1 | 1 | 0.9 | 10.3 x 18.6 | 52.2 |

4 SECTION CABLES

MULTI CORE FLAT TWIN SHEATH

SPECIFICATIONS

Applications: Battery Feeds, Charges, Winches, Power & Solar Generators

Conductor: OXYGEN FREE Plain Copper Wire to AS/NZS 1125

Insulation: V90 PVC to AS/NZS 3808

Core Colours: Red, Black

Sheath: V90 PVC to AS/NZS 3808

Sheath Colours: Black / Red

Packs: 30, 50, 100 metres



| Part Number | Description |
|------------------|---|
| 500-08184 | MARINE DC Cable 100m Reel - TINNED 3MM WHITE Twin Sheath 2-CORE FLAT. MWS21603-WH-100 |
| 500-08186 | MARINE DC Cable 100m Reel - TINNED 4MM WHITE Twin Sheath 2-CORE FLAT. MWS22603-WH-100 |
| 500-08188 | MARINE DC Cable 100m Reel - TINNED 6MM WHITE Twin Sheath 2-CORE FLAT. MWS26503-WH-100 |

| MM Industry Equiv. | Nominal Area (mm ²) | Conductor No/Dia (mm) | Insulation Thickness (mm) | Sheath Thickness (mm) | AMP Rating at 30°C | Electrical Resistance at 20°C (ohm/km) | Nominal O.D. (mm) | Mass (kg/100m) |
|--------------------|---------------------------------|-----------------------|---------------------------|-----------------------|--------------------|--|-------------------|----------------|
| 3 | 1.13 | 14/0.32 | 0.4 | 0.6 | 16 | 16.7 | 3.3 x 5.5 | 4.1 |
| 4 | 1.84 | 23/0.32 | 0.4 | 0.6 | 22 | 10.2 | 3.8 x 6.3 | 6.1 |
| 6 | 4.5 | 57/0.32 | 0.6 | 0.8 | 38 | 4.15 | 5.7 x 9.6 | 14 |

MULTI CORE FLAT TWIN SHEATH BATTERY

SPECIFICATIONS

TINNED COPPER WIRE (TCW) TO AS/NZS 1125

Applications: Battery Winches, Feeds, Charges, Power & Solar Generators

Insulation: RoHS Compliant 5V90 P.V.C. to AS/NZS 3808

Core Colours: Red, Black

Sheath: RoHS Compliant 5V90 P.V.C. to AS/NZS 3808

Sheath Colours: Black

Packs: 30 metres - other packs by request



| Part Number | Description |
|------------------|--|
| 500-08190 | MARINE DC Cable 30m Reel - TINNED 8B&S BLACK Twin Sheath 2-CORE FLAT. MWS296032-BK-30 |
| 500-08192 | MARINE DC Cable 30m Reel - TINNED 6B&S BLACK Twin Sheath 2-CORE FLAT. MWS2168032-BK-30 |
| 500-08194 | MARINE DC Cable 30m Reel - TINNED 2B&S BLACK Twin Sheath 2-CORE FLAT. MWS2399032-BK-30 |

| Conductor No/Dia (mm) | Nearst B & S | Nominal Area (mm ²) | Insulation Thickness (mm) | Sheath Thickness (mm) | AMP Rating at 30°C | Electrical Resistance at 20°C (ohm/km) | Nominal O.D. (mm) | Mass (kg/100m) |
|-----------------------|--------------|---------------------------------|---------------------------|-----------------------|--------------------|--|-------------------|----------------|
| 96/0.32 | 8 | 7.7 | 0.9 | 0.8 | 59 | 2.43 | 7.1x 12.5 | 22 |
| 168/0.32 | 6 | 13.5 | 1.1 | 0.8 | 82 | 1.42 | 8.8x 16.0 | 36 |
| 399/0.32 | 2 | 32 | 1.7 | 0.96 | 150 | 0.61 | 13.0x 24.0 | 83 |

SINGLE CORE BATTERY

SPECIFICATIONS

V90 P.V.C. TO AS/NZS 3808

Applications: Pleasure Craft, Extra Low Voltage Applications

Conductor: TINNED COPPER WIRE (TCW) to AS/NZS 1125

Insulation: RoHS Compliant

Colours: Black

Packs: 30 metres



| Part Number | Description |
|------------------|---|
| 500-08196 | MARINE DC Cable 30m Reel - TINNED 2B&S BLACK Battery Cable. MBS145503-BK-30 |

| Nearst B & S | Conductor No/Dia (mm) | Nominal Area (mm ²) | Insulation Thickness (mm) | AMP Rating at 30°C | Electrical Resistance at 20°C (ohm/km) | Nominal O.D. (mm) | Mass (kg/100m) |
|--------------|-----------------------|---------------------------------|---------------------------|--------------------|--|-------------------|----------------|
| 2 | 399/0.32 | 32 | 1.7 | 188 | 0.62 | 10.3 | 36.5 |

AUTO MULTI - CORE TRAILER CABLE

SPECIFICATIONS

V90 PVC INSULATED AND SHEATHED

Applications: Caravan and Trailer Wiring

Conductor: OXYGEN FREE Plain Copper Wire to AS/NZS 1125

Insulation: V90 PVC to AS/NZS 3808

Core Colours: 1. White 2. Yellow 3. Brown 4. Red 5. Green 6. Black 7. Blue

Sheath: 5V90 PVC to AS/NZS 3808

Sheath Colour: Black

Packs: 30, 100 metres



| Part Number | Description |
|------------------|---|
| 500-08200 | AUTO Cable 30m Reel - 5 CORE x 3MM BLACK MULTI-CORE Trailer. ATC51603-BK-30 |
| 500-08202 | AUTO Cable 100m Reel - 5 CORE x 3MM BLACK MULTI-CORE Trailer. ATC51603-BK-100 |
| 500-08204 | AUTO Cable 30m Reel - 5 CORE x 4MM BLACK MULTI-CORE Trailer. ATC52603-BK-30 |
| 500-08206 | AUTO Cable 100m Reel - 5 CORE x 4MM BLACK MULTI-CORE Trailer. ATC52603-BK-100 |
| 500-08208 | AUTO Cable 30m Reel - 7 CORE x 3MM BLACK MULTI-CORE Trailer. ATC71603-BK-30 |
| 500-08210 | AUTO Cable 100m Reel - 7 CORE x 3MM BLACK MULTI-CORE Trailer. ATC71603-BK-100 |
| 500-08212 | AUTO Cable 30m Reel - 7 CORE x 4MM BLACK MULTI-CORE Trailer. ATC72603-BK-30 |
| 500-08214 | AUTO Cable 100m Reel - 7 CORE x 4MM BLACK MULTI-CORE Trailer. ATC72603-BK-100 |

| MM Industry Equiv. | No. of Cores | Strand No. / Size | Nominal Area (mm ²) | AMP Rating at 30°C | Insulation Thickness (mm) | Sheath Thickness (mm) | Electrical Resistance at 20°C (ohm/km) | Nominal O.D. (mm) | Mass (kg/100m) |
|--------------------|--------------|-------------------|---------------------------------|--------------------|---------------------------|-----------------------|--|-------------------|----------------|
| 3 | 5 | 14/0.32 | 1.13 | 11 | 0.4 | 0.6 | 16.8 | 7.1 | 9.1 |
| 4 | 5 | 23/0.32 | 1.84 | 15 | 0.4 | 0.6 | 10.3 | 8.2 | 13.1 |
| 3 | 7 | 14/0.32 | 1.13 | 10 | 0.4 | 0.6 | 16.8 | 7.7 | 12.1 |
| 4 | 7 | 23/0.32 | 1.84 | 14 | 0.4 | 0.6 | 10.3 | 8.9 | 1 |

MARINE MULTI CORE TRAILER CABLE

SPECIFICATIONS

V90 PVC INSULATED

Applications: Marine Trailer Wiring

Conductor: TINNED COPPER WIRE (TCW) to AS/NZS 1125

Insulation: RoHS Compliant

Core Colours: 3 Core: White, Yellow, Brown 5 Core: White, Yellow, Brown, Red, Green 7 Core: White, Yellow, Brown, Red, Green, Blue, Blacklue

Sheath: RoHS Compliant 5V90 P.V.C. to AS/NZS 3808

Sheath Colour: White

Packs: 350, 100 metres - coils available by request



| Part Number | Description |
|------------------|---|
| 500-08216 | MARINE DC Cable 50m Reel - TINNED 3-CORE x 4MM WHITE Multi-Core. MTS32603-WH-50 |
| 500-08218 | MARINE DC Cable 100m Reel - TINNED 3-CORE x 4MM WHITE Multi-Core. MTS32603-WH-100 |

| No. of Cores | Nominal Area (mm ²) | Conductor No/Dia (mm) | Insulation Thickness (mm) | Sheath Thickness (mm) | AMP Rating at 30°C | Electrical Resistance at 20°C (ohm/km) | Nominal O.D. (mm) | Mass (kg/100m) |
|--------------|---------------------------------|-----------------------|---------------------------|-----------------------|--------------------|--|-------------------|----------------|
| 3 | 1.84 | 23/0.32 | 0.4 | 0.6 | 19 | 10.2 | 7.2 | 8.4 |

FIGURE 8 BATTERY

SPECIFICATIONS

V90HT PVC INSULATION AND SHEATH

Applications: Indoors and Outdoors, Motorised Vehicles, Fork Lifts, Field Conveyor, In High Quality Booster Cables, Battery and Starter

Conductor: Nominal 0.2mm OXYGEN FREE Plain Copper Wire to AS/NZS 1125

Insulation: V90HT PVC to AS/NZS 3808 0.6/1KV

Core Colours: Red and Blue | LDX2CBB20A *** Red and Black

Sheath: UV Stabilised PVC type rated V90HT to AS/NZS 3808

Sheath Colour: Clear

Packs: 50 or 100 metres



| Part Number | Description |
|------------------|--|
| 500-08220 | AUTO Cable 50m Reel - 10MM SQUARE FIGURE 8. LDX2CBB20A-CL-50 |

| Conductor No/Dia (mm) | Nominal Area (mm ²) | Insulation Thickness (mm) | Sheath Thickness (mm) | AMP Rating at 30°C | Electrical Resistance at 20°C (ohm/km) | Nominal O.D. (mm) | Mass (kg/100m) |
|-----------------------|---------------------------------|---------------------------|-----------------------|--------------------|--|-------------------|----------------|
| 50/0.25 | 2.5 | 0.8 | 0.8 | 25 | 7.98 | 5.3x11.0 | 9.6 |

4 SECTION CABLES

MULTI CORE TRAILER CABLE

SPECIFICATIONS

V90 PVC INSULATED

Applications: Marine Trailer Wiring

Conductor: TINNED COPPER WIRE (TCW) to AS/NZS 1125

Insulation: RoHS Compliant

Core Colours: Colours: 3 Core: White, Yellow, Brown

5 Core: White, Yellow, Brown, Red, Green

7 Core: White, Yellow, Brown, Red, Green, Blue, Black

Sheath: RoHS Compliant 5V90 P.V.C. to AS/NZS 3808

Sheath Colour: White

Packs: 50 or 100 metres



| Part Number | Description |
|------------------|---|
| 500-08221 | MARINE DC Cable 50m Reel - TINNED 7-CORE x 4MM WHITE Multi-Core. MTS72603-WH-50 |
| 500-08222 | MARINE DC Cable 50m Reel - TINNED 7-CORE x 4MM WHITE Multi-Core. MTS72603-WH-50 |

| Nearst B & S | Nominal Area (mm ²) | Conductor No/Dia (mm) | Insulation Thickness (mm) | Sheath Thickness (mm) | AMP Rating at 30°C | Electrical Resistance at 20°C (ohm/km) | Nominal O.D. (mm) | Mass (kg/100m) |
|--------------|---------------------------------|-----------------------|---------------------------|-----------------------|--------------------|--|-------------------|----------------|
| 7 | 1.84 | 23/0.32 | 0.4 | 0.6 | 14 | 10.3 | 9 | 17.7 |

BUILDING CABLE

SPECIFICATIONS

SINGLE CORE V90HT P.V.C. TO AS/NZS 5000.10.6/1KV VOLTAGE RATING

Applications: Building / Power Cable 0.6/1KV

Conductor: Plain Copper Wire to AS1125

Insulation: V90HT PVC to AS3808

Core Colours: Black, Blue, Brown, Orange, Violet, Red, White, Grey, Green/ Yellow - Stripes available by request

Packs: 100, 500 metres

Typical Properties - Standard: AS5000.1



| Part Number | Description |
|------------------|--|
| 500-08300 | 240V Cable 100m Reel - 2.5MMSQ Green & Yellow Single Core. BVD17067-GNYW-100 |

| Conductor No/Dia (mm) | Nominal Area (mm ²) | Insulation Thickness (mm) | Electrical Resistance at 20°C (ohm/km) | Nominal O.D. (mm) | Mass (kg/100m) |
|-----------------------|---------------------------------|---------------------------|--|-------------------|----------------|
| 7/0.67 | 2.5 | 0.8 | 7.4 | 3.65 | 3.3 |

THERMOPLASTIC SHEATHED (TPS) FLAT

SPECIFICATIONS

V90 P.V.C. TO AS/NZS 5000.2 - 450/750V VOLTAGE RATING

Applications: Easy-tear PVC sheath for fixed applications in power and lighting circuits in installations up to and including 450/750V

Conductor: OXYGEN FREE Plain Copper Wire to AS/NZS 1125

Insulation: RoHS Compliant V90 P.V.C. to AS/NZS 3808

Core Colours: Colours: 2 Core: Red, Black

2 Core + Earth: Red, Black, Green / Yellow

Sheath: RoHS Compliant 3V90 P.V.C. to AS/NZS 3808

Sheath Colour: White

Packs: 100 metres - other packs by request



| Part Number | Description |
|------------------|--|
| 500-08310 | 240V Cable 100m Reel - 2.5MMSQ Twin & Earth White TPS Flat 450/750V 90C. BEM37067-WH-100 |
| 500-08312 | 240v Cable 100m Reel - 2.5MMSQ Twin & Earth Violet TPS Flat RVSPEC 450/750V. BED37067-VL-100 |

| No. of Cores | Nominal Area (mm ²) | Main Conductor Type | Conductor No/Dia (mm) Power & Earth | Insulation Thickness (mm) | Sheath Thickness (mm) | Electrical Resistance at 20°C (ohm/km) | Nominal O.D. (mm) | Mass (kg/100m) |
|--------------|---------------------------------|---------------------|-------------------------------------|---------------------------|-----------------------|--|-------------------|----------------|
| 2C + E | 2.5 | Strand Cu | 7/0.67 | 0.7 | 1 | 7.4 | 5.5 x 12.2 | 14 |

CO-AXIAL CABLE RG6 QUAD SHIELD

SPECIFICATIONS

COAXIAL CABLE - RG6 QUAD SHIELD

Applications: General Purpose Co-Ax, Interconnections of Electronic Equipment & Instruments

Sheath Colour: Black

Packs: 100 metres



| Part Number | Description |
|------------------|--|
| 500-05599 | MEDIA Cable 100m Reel - RG6 BLACK QUAD Shield. CKC11035-BK-100 |

| RG Type | Conductor No/Dia (mm) | Insulation Type | Insulation (mm) | Screen Type | Screen % | Sheath Type | Sheath (mm) | Mass (kg/100m) |
|----------------|-----------------------|-----------------|-----------------|-------------|----------|-------------|-------------|----------------|
| RG Quad Shield | 1.02 CCS | Foam PE | 4.57 | 1 x Al Foil | Bonded | PVC | 7.54 | 10 |

CAFRAMO FANS



Coast to Coast's range of high quality Caframo fans are researched, designed, developed and manufactured in Canada for the world.

Caframo fans are constructed with the highest quality and greatest care to deliver high-end, unique products boasting features to increase your comfort. All of the fans can be either surface or flush mounted and are available in black or white.

SIROCCO II

The all new Sirocco II fan features a unique gimbaled design that allows 360° airflow with versatile 12/24 Volt auto-sensing capability. The improved control layout, increased timer settings and quieter operation make the Sirocco II the perfect choice for caravanning in comfort.

SPECIFICATIONS

Colours: Black and White

Product Size (mm): 90(L) x 241(W) x 305(H)

Product Weight: 1.2kg

500-10002

CAFRAMO SIROCCO II 12/24V BLACK 7" GIMBAL FAN WITH 3 SPEED



500-10000

CAFRAMO SIROCCO II 12/24V WHITE 7" GIMBAL FAN WITH 3 SPEED



CAFRAMO FANS

BORA

The quietest and most powerful fan in its class! The model 748 Bora 12 Volt fan is designed to deliver the features needed to solve any airflow challenge. The Bora features a long-life motor with center push control, grills on front and back and built-in handle for easy up/ down or side-to-side positioning.

SPECIFICATIONS

Colours: Black and White
 Product Size (mm): 90(L) x 165(W) x 241(H)
 Product Weight: 0.7kg

500-10004
CAFRAMO BORA 12V WHITE 6" FAN WITH 3 SPEED

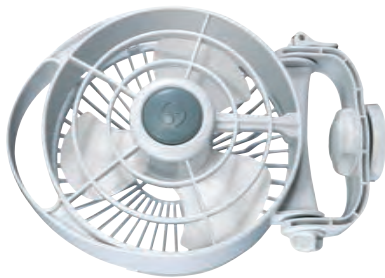

500-10006
CAFRAMO BORA 12V BLACK 6" FAN WITH 3 SPEED



MAESTRO

Building on the popularity of the original Bora™ fans, the Maestro™ boasts an improved design along with a bright LED for use at night. Equipped for wall mounting, its convenient wired remote pendant control can be located up to six feet away from the fan.

SPECIFICATIONS

Colours: Black and White
 Product Size (mm): 97(L) x 165(W) x 241(H)
 Product Weight: 0.7kg

500-10008
CAFRAMO MAESTRO 12V WHITE 6" VARIABLE SPEED FAN WITH LIGHT AND WIRED CONTROL



500-10010
CAFRAMO MAESTRO 12V BLACK 6" VARIABLE SPEED FAN WITH LIGHT AND WIRED CONTROL



BRIGGS & STRATTON INVERTER GENERATORS

500-30650

P2400 BRIGGS & STRATTON 2400-WATT INVERTER GENERATOR

Enjoy the little conveniences of home anywhere. Quietly. Because of the Quiet Power Technology®, our inverter generators are quieter than traditional camping generators. This P2400 PowerSmart Series™ generator is also safe for sensitive equipment, like your smartphone, laptop, TV and game systems. The handy portable generator can supply your equipment with power for 8 hours straight (at 25% load). It delivers 2400 starting watts and 1800 running watts. This P2400 features 2x 230V household sockets, one 12V DC charging outlet and two 5V USB ports. Do you need more power? You can link two inverter generators with the optional connector kit.



Briggs & Stratton petrol inverter generators are compact and easy to manoeuvre. While providing the power you need. These inverter generators are low maintenance, and ready for all your outdoor leisure needs.

Features

- > Safe for Sensitive Electronics
- > Designed for Camping
- > Quiet Power Technology
- > Quiet Portable Generator
- > Multiple Outlets for Your Power Needs
- > Easy Mobility
- > Parallel Connector Port
- > CO Guard™ Carbon Monoxide Shutdown

SPECIFICATIONS

Starting Watts: 2400
 Running Watts: 1800
 Voltage (V): 230
 Frequency (Hz): 50
 Noise Level (dB(A)): 58
 Run Time: 8h
 Outlets: 2x 230V / 16 Amp, 1x 12V / 5 Amp DC Charging outlet, 2x USB
 Starter: Recoil
 Engine Configuration: 4-stroke OHV
 Displacement (cc): 79
 Fuel Tank Capacity (l): 3,8
 Automatic Low Oil Shut Down: Yes
 Circuit Breaker: Yes
 Transport Handle: Twin carry handle, optional wheel kit
 Weight (kg): 22,7
 Length (cm): 51
 Width (cm): 31
 Height (cm): 44

500-30651

P3400 BRIGGS & STRATTON 3400-WATT INVERTER GENERATOR

Briggs & Stratton petrol inverter generators are compact and easy to manoeuvre. While providing the power you need. These inverter generators are low maintenance, and ready for all your outdoor leisure needs.



- > CO Guard™ - Shuts down your generator when harmful levels of carbon monoxide are detected
- > QPT™ Quiet Power Technology - Automatically adjusts the engine speed further reducing noise and fuel consumption
- > Easy Portability with telescopic handle and integrated wheels
- > The PowerSmart Series Inverter Generators deliver 'pure sine waves' at 3400 watts peak and 2800 watts continuous making it
- > Ideal for sensitive electronic equipment
- > StatStation™ Digital Display - Displays power usage, total unit lifetime hours, and maintenance reminders.
- > Up to 8 hours run time @ 25% load

SPECIFICATIONS

Number of Outlets: 3
 Engine: Briggs & Stratton® OHV
 Displacement: 171cc
 Amperage: 15A
 Voltage: 230V AC
 Auto Idle: Yes
 Auto Voltage Regulation Inverter
 Fuel Tank Capacity (L): 5.7
 Muler: Yes - Spark Arrestor Type
 Weight (Kg): 38.6
 Low Oil Protection System: Yes
 RCD: No
 Dimensions L x W x H (cm): 66 x 35.2 x 51.7

500-30652

P4500 BRIGGS & STRATTON 4500-WATT INVERTER GENERATOR

Enjoy the little conveniences of home anywhere. Because of the Quiet Power Technology®, our inverter generators are quieter than traditional camping generators. This P4500 PowerSmart Series™ generator is also safe for sensitive equipment, like your smartphone, laptop, TV and game systems. This portable generator can supply your equipment with power for 16 hours straight (at 25% load). It delivers 4500 starting watts and 3700 running watts.



SPECIFICATIONS

Starting Watts: 4500
 Running Watts: 3700
 Voltage (V): 230
 Frequency (Hz): 50
 Noise Level (dB(A)): 61
 Run Time: 16h
 Outlets: 2x 230V / 16 Amp, 1x 12V / 5 Amp DC Charging outlet, 2x USB
 Starter: Electric/Recoil
 Engine Configuration: 4-stroke OHV
 Displacement (cc): 224
 Fuel Tank Capacity (l): 13
 Automatic Low Oil Shut Down: Yes
 Circuit Breaker: Yes
 Transport Handle: Telescopic handle, side handles, integrated wheels
 Weight (kg): 52,1
 Length (cm): 62
 Width (cm): 44
 Height (cm): 52

4 SECTION GAS EQUIPMENT

GAS ACRONYMS

| | |
|------|--|
| BSP | British Standard Pipe |
| BSPT | British Standard Pipe Tapered |
| NPT | National Pipe Thread |
| POL | Prest-O-Lite |
| SAE | Society of Automotive Engineers |
| M | This indicates that it is a male fitting |
| F | This indicates that it is a female fitting |

For your own safety all gas fittings and equipment should be installed and checked by a qualified person.

550-00100 YELLOW GAS SEAL TAPE

Has a heat resistance of +200°C & a cold resistance of up to -20°C. Pressure resistant up to 2600kPa & is made of sintered PTFE (Poly Tetra Fluoro Ethylene).



Specifications

Dimensions: 12mm (W) x 10m (L)

LCI LIPPERT BOTTLECHECK BLUETOOTH GAS GAUGE

Easily check gas bottle levels using BottleCheck Bluetooth sensor and smartphone application. BottleCheck gives you peace of mind, measuring the LPG level and alerting you before you run out. BottleCheck can be used on tanks in RVs, caravans, heaters, BBQ grills.

Keep on top of your gas bottle level using the LCI BottleCheck Bluetooth Sensor! Download the FREE app and track the gas level right from your smartphone.

BottleCheck sensors are magnetically attached to the bottom of the gas bottle. The sensors periodically measure propane levels and wirelessly send the fill level to the BottleCheck app.

Available in single or double sensor kits.

SPECIFICATIONS

Sensor Siz.: 72mm Diameter 8mm High
Weight: 30 Grams
Bluetooth Range: 50 Ft
Measures: LPG only
Temp Range: -30°C to + 55°C
IP Rating: IP64

550-00020 LCI LIPPERT BOTTLECHECK BLUETOOTH GAS GAUGE - SINGLE SENSOR KIT



550-00022 LCI LIPPERT BOTTLECHECK BLUETOOTH GAS GAUGE - TWIN SENSOR KIT



LOXEAL 58-11 HIGH PRESSURE THREAD SEALANTS

Ideal for sealing threaded joints against gas, water, oils and other chemicals.

- > Anaerobic adhesive for the sealing of threaded metal to metal joints
- > Seals against gas, water, LPG, hydrocarbons, oils and other chemicals
- > High viscosity - won't run on thread
- > Sealing unaffected by shock/vibration within temperature range: -55°C to + 150°C
- > Rapid cure time - functional in less than 3 hours
- > Water-safe & AGA-approved

550-00104 100ML TUBE



550-00106 250ML TUBE



REGULATORS

550-00302 LPG (SINGLE STAGE) GAS REGULATOR

3.5kg/hr adjustable soft nose BBQ regulator 3/8" BSPF outlet.



550-00304 GAS CYLINDER 2 STAGE ADJ.160MJ REGULATOR



550-00306
GAS CYLINDER 2 STAGE
ADJ.160MJ REGULATOR KIT
-DUAL
 Adjustable Regulator



PIGTAIL

550-00320
COPPER PIGTAIL
POL X 1/4"
INVERTED FLARE (750MM
LONG)



550-00310
GAS REGULATOR 160MJ
WITH BRACKET &
PIGTAIL ADAPTOR



550-00330
COPPER PIGTAIL
POL X 1/4"
INVERTED FLARE (450MM)

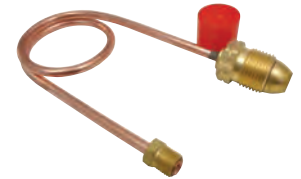

550-00312
GAS REGULATOR 160MJ
MANUAL CHANGE OVER &
BRACKET



GAS HOSES

550-00332
8MM S/S FLEXIBLE HOSE
900MM FOR SINGLE BOTTLE
KITS



550-00314
SINGLE GAS CYLINDER
REGULATOR KIT
 Single regulator with elbow, metal bracket, 3/8" adaptor with T point & flexible hose with hand wheel. Comes assembled.



550-00333
8MM S/S FLEXIBLE HOSE
600MM FOR SINGLE BOTTLE
KITS



550-00316
DUAL GAS CYLINDER
REGULATOR KIT
 Manual change over regulator, metal bracket, 3/8" adaptor with T point & 2 flexible hoses with hand wheel. Comes assembled.



550-00334
8MM S/S FLEXIBLE HOSE
450MM
 For single bottle kits (avalanche valve x 1/4" BSPM male)



550-00318
MARSHALL 2 STAGE HIGH-
CAPACITY LPG REGULATOR 290MJ
1/4"FNPT X 3/8"FNPT
 High Capacity Compact Integral Two Stage Regulator is approved for use in nearly all portable applications and light duty domestic home installations. Ideally suited for RV, outdoor appliances, cabins, seasonal homes, gas fire places, water heaters, ranges or the other moderate to low demand domestic home installations.



4 SECTION

GAS EQUIPMENT

550-00336
8MM S/S FLEXIBLE HOSE
450MM

For double bottle kits
(avalanche valve x inverted
flare)



550-00337
8MM S/S FLEXIBLE HOSE
600MM

For double bottle kits
(avalanche valve x inverted
flare)



550-00338
8MM S/S FLEXIBLE HOSE
900MM

For double bottle kits
(avalanche valve x inverted
flare)



550-00340
S/S FLEXIBLE HOSE 450MM
with hand wheel for single bottle kit.
(POL x 1/4" NPTM)



550-00341
S/S FLEXIBLE HOSE 600MM
with hand wheel for single bottle
kit. (POL x 1/4" NPTM)



550-00344
S/S FLEXIBLE HOSE 450MM
with hand wheel for double bottle
kit
(POL x 5/16")



550-00345
S/S FLEXIBLE HOSE 600MM
with hand wheel for double bottle kit
(POL x 5/16")
Class: F, 6mm, 2600Kpa



550-00349
S/S FLEXIBLE HOSE 3000MM
With Male Bayonet + Handle 3/8 Sae F



550-00350
VALVE & ADAPTER
Manual changeover valve t/s
regulator



550-00360
MOUNTING BRACKET
A universal regulator bracket
(i.e. suits single, twin stage
regulators)

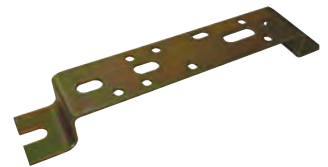

550-00370
SCREWS FOR MOUNTING BRACKET



550-00380
INVERTED FLARE STRAIGHT
MALE UNION ADAPTER
2 stage gas regulator. (1/4" NPTM
x 1/4" female inverted flare)



550-00390
INVERTED FLARE 90° ELBOW
MALE UNION ADAPTOR
2 stage gas regulator. (1/4" MNPT
x 1/4" female inverted flare)



550-00452
BROMIC 6MM/450MM SS
TYPE 27 PIGTAIL LCC27
CLASS F X 7/16 - 24 I/F



550-00454
BROMIC 6MM/600MM SS
TYPE 27 PIGTAIL LCC27 CLASS F X 7/16 - 24 I/F

550-00456
BROMIC 6MM/450MM SS TYPE 27 PIGTAIL
LCC27 CLASS F X 1/4" NPT M

550-00458
BROMIC 6MM/600MM SS TYPE 27 PIGTAIL
LCC27 CLASS F X 1/4" NPT M

From April 1st 2022 new gas installations in caravans and boats must be supplied with the new LCC27 connection for cylinders not exceeding 25L water capacity.

550-00500
GAS HOSE 3/8" BSPM X
3/8" SAEM X 300MM



550-00510
GAS HOSE - 6MM PVC,
5/16" SAE MF
X 3/8" BSP M, 300MM



For use with LPG (propane)

SPECIFICATIONS

Inlet: 5/16" SAE MF
 Outlet: 3/8" BSP M
 AGA Approval: 4237
 Gas Hose Class (Max Working Pressure/Working Temp): C (2600kPa/-200C to +650C)
 Hose Diameter: 6mm

550-00550
GAS HOSE 3/8" BSPM X
1/4" BSPF X 600MM



550-00560
GAS HOSE 3/8" BSPM X 1/4"
BSPF X 900MM



550-00570
GAS HOSE 3/8" BSPM X 1/4"
BSPF X 1200MM



550-00600
SAE MALE X BSP FEMALE UNION
5/16" X 1/4"



550-00602
SAE MALE X BSP FEMALE UNION
5/16" X 3/8"



550-00604
SAE MALE X BSP FEMALE
UNION 3/8" X 1/4"



550-00606
SAE MALE X BSP FEMALE
UNION 3/8" X 3/8"



550-00608
SAE MALE X BSP FEMALE UNION
3/8" X 1/2"



550-00610
SAE MALE X SAE MALE DOUBLE
UNION
5/16" X 5/16"



550-00612
SAE MALE X SAE MALE DOUBLE
UNION 3/8" X 3/8"



550-00614
REDUCING UNION
3/8" X 5/16"



4 SECTION

GAS EQUIPMENT

550-00616
SAE MALE X SAE MALE DOUBLE
ELBOW 5/16" X 5/16"



550-00634
SAE 450 FLARE BRASS
FITTING, MALE UNION, 5/16
TUBE, 3/8 BSPT



550-00618
SAE ALL MALE 3-WAY TEE
CONNECTOR 5/16"



550-00636
SAE MALE X BSP TAPERED MALE
UNION 3/8" X 1/8"



550-00620
SAE ALL MALE 3-WAY TEE
CONNECTOR 3/8"



550-00638
SAE MALE X BSP TAPERED
MALE UNION 3/8" X 1/4"



550-00622
BSP MALE TAPERED X BSP FEMALE
ELBOW 1/4" X 1/4"



550-00640
SAE MALE X BSP TAPERED
MALE UNION 3/8" X 3/8"



550-00624
SAE FLARE NUT 5/16"



550-00642
SAE MALE X BSP MALE
TAPERED ELBOW 5/16" X 1/4"



550-00626
SAE FLARE NUT 3/8"



550-00644
SAE MALE X BSP MALE TAPERED
ELBOW 5/16" X 3/8"



550-00628
SAE REDUCING FLARE NUT
3/8" X 5/16"



550-00646
BALL VALVE BSP FEMALE
X BSP
FEMALE 1/4" X 1/4"



550-00630
SAE 45° FLARE BRASS FITTING,
MALE UNION, 5/16 TUBE, 1/8 BSPT



550-00648
FLARED BALL VALVE
5/16" X 5/16" SAE



550-00632
SAE MALE X BSP TAPERED MALE
UNION 5/16" X 1/4"



550-00650
FLARED BALL VALVE 3/8" X 3/8" BSP



550-00652
FLARED BALL VALVE 1/2" X 1/2" BSP



550-00700
GAS TESTING NIPPLE 3/8" flare x 3/8" male

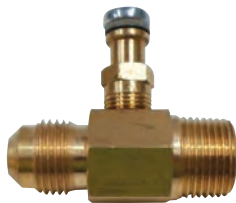

550-00710
GAS FLOOR SOCKET FEMALE CHROME
 Manufactured from high quality brass and stainless steel. The unit is corrosion resistant and is approved to the AGA requirements. Chrome plated, with the inlet being a 1/2" BSP threaded connection. (7Kpa)



550-00711
DUST CAP T/S CHROME PLATED BAYONETS
 Dust cover to suit bayonet outlet.



550-00712
MALE BAYONET SOCKET 1/4" BSP
 Comes with a 1/4" BSP male nipple for screw on attachment to a standard gas hose with compatible female union fittings.



GAS CYLINDERS

550-01002
MANCHESTER 9KG GRADE 2 GAS CYLINDER WITH LCC 27 VALVE NO GUAGE



550-01012
MANCHESTER 4KG GRADE 2 GAS CYLINDER WITH LCC 27 VALVE NO GUAGE



550-01302
STRAP RATCHET T/S GAS BOTTLE
 Ratchet strap to suit gas bottles.



CRADLES

550-01052
CRADLE T/S 9KG (GALVANISED)
 With a quick release mechanism.



550-01062
CRADLE T/S 4KG (GALVANISED)
 With a quick release mechanism.

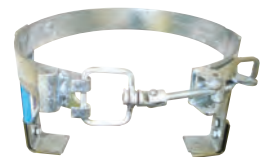

550-02010
12V GAS DETECTOR
 Can be installed in homes, motor homes, caravans and the like. It detects a gas leakage and triggers the alarm when the gas level reaches 10% of the LEL (Lowest Explosion Limit) in the air. 120H x 80W x 40D (mm)



550-01300
GAS BOTTLE SLIDE (WITH THUMB LOCKS)
 Made from mild steel, this slide holds x2 9kg gas bottles.



SPECIFICATIONS

Weight: 5.2kg
 Dimensions: 656 x 280 x 285 (mm)

Lined area for notes with horizontal dotted lines.

A series of horizontal dotted lines for writing notes.

Lined area for notes with horizontal dotted lines.

SECTION

5

CARAVAN HARDWARE

(Product Group - 600)

| | |
|--|-----------|
| Coast Access Doors | 208 - 210 |
| Grab Handles and Cabin Hooks | 210 - 212 |
| Thetford Service Doors | 212 - 213 |
| Rosettes, Nickels and Door Locks | 213 - 214 |
| Valterra Access Hatches | 215 |
| Window Parts | 215 - 216 |
| DGN Hinges | 216 |
| Caravan Cleaners, Touch Up Paint and Sealers | 217 - 221 |

HATCHES & VENTS

(Product Group - 650)

| | |
|--|-----------|
| Elixir Mini Vent | 222 |
| Ventline Vents and Spares | 222 - 223 |
| Unimaxx Replacement Vent Lids | 223 |
| Four Seasons Hatch and Spares | 223 - 224 |
| Fantastic Vents and Spares | 224 |
| Dust Reduction System | 224 |
| Fiamma Hatches, Vents and Hatch Spares | 225 - 226 |
| MaxxAir Ventilation | 226 - 227 |
| Skymaxx Ventilation | 228 - 229 |
| Exterior, Rotary and Scupper Vents | 229 - 230 |

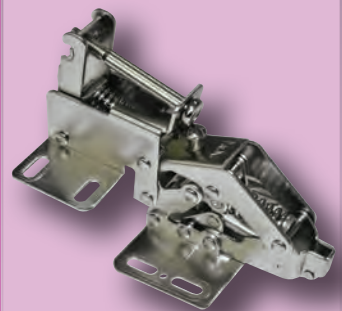

COAST DOORS

Utilise the cavities in your RV body to create much needed storage space and use the Coast Doors to access them. Available in ten handy sizes, the Coast Doors are available in black and white. Installation has been streamlined - screw holes are pre-drilled and they are supplied as a complete door, meaning there is no need to infill. It features an effective door seal and comes with keys to lock and reopen.

600-00000 COAST DOOR 1

Has one centre lock and one set of keys. (M500-100)

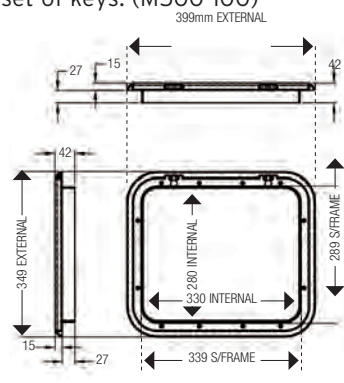

600-00002 COAST DOOR 2

Has two locks and two sets of keys. (M500-110)

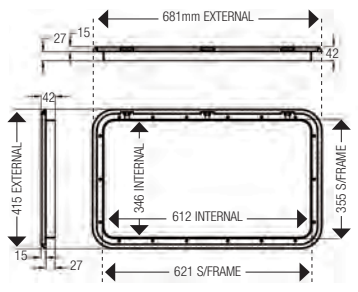

600-00004 COAST DOOR 3

Has two locks and two sets of keys. (M500-120)

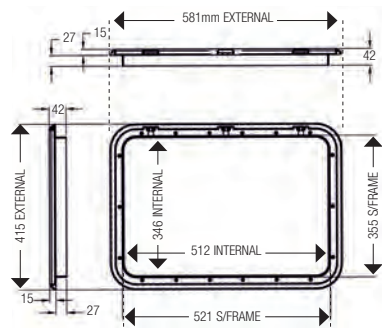

600-00006 COAST DOOR 4

Has two locks and two sets of keys. (M500-130)

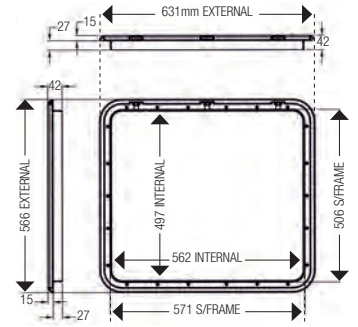

600-00008 COAST DOOR 5

Has two locks and two sets of keys. (M500-140)

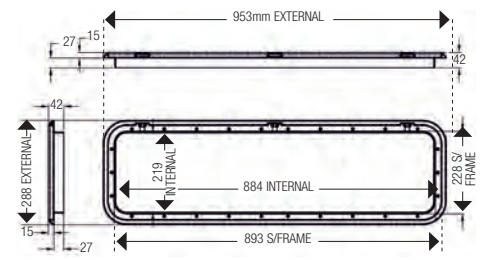

600-00010 COAST DOOR 6

Has two locks and two sets of keys. (M500-150)

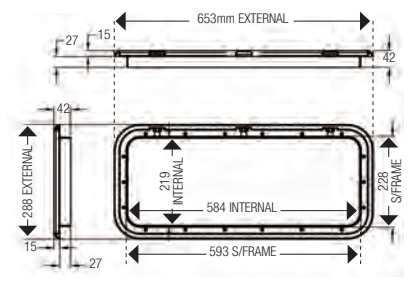

600-00012 COAST DOOR 7

Suitable for installation on the 'entry' side of the caravan.

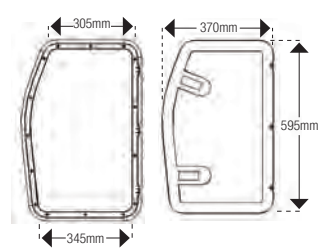

600-00014

COAST DOOR 8

Suitable for installation on the 'closed' side of the caravan.

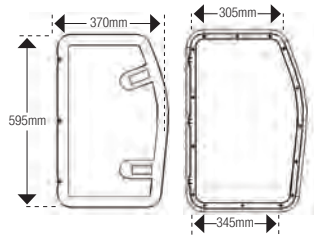

600-00022

COAST DOOR 2 (BLACK)

Has two locks and two sets of keys. (M500-210)

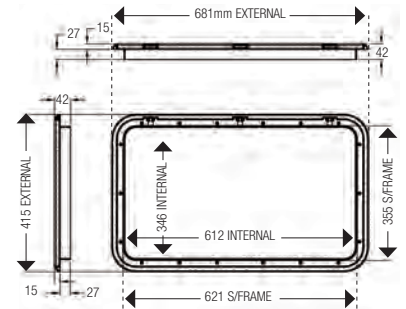

600-00016

COAST DOOR 9

Has two locks and two sets of keys.

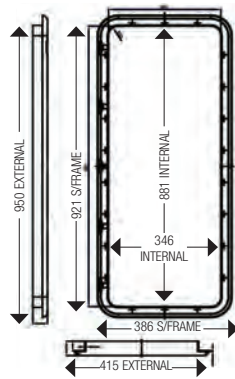

600-00024

COAST DOOR 3 (BLACK)

Has two locks and two sets of keys. (M500-220)

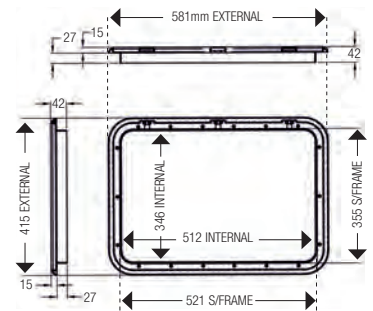

600-00018

COAST DOOR 10 TUNNEL BOOT DOOR

Has two locks and two sets of keys.

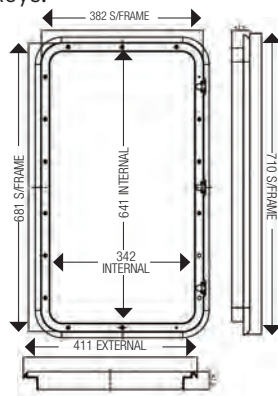

600-00026

COAST DOOR 4 (BLACK)

Has two locks and two sets of keys. (M500-230)

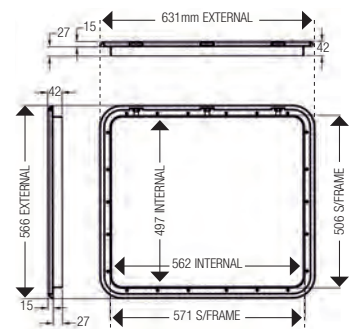

600-00020

COAST DOOR 1 (BLACK)

Has one centre lock and one set of keys. (M500-200)

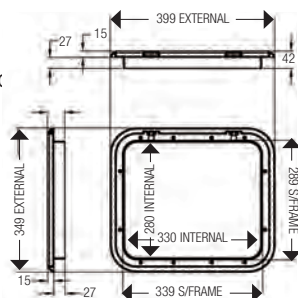

600-00028

COAST DOOR 5 (BLACK)

Has two locks and two sets of keys. (M500-240)

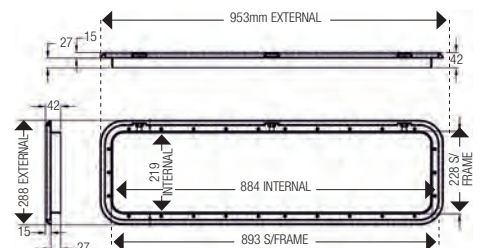

600-00030
COAST DOOR 6 (BLACK)

Has two locks and two sets of keys. (M500-250)

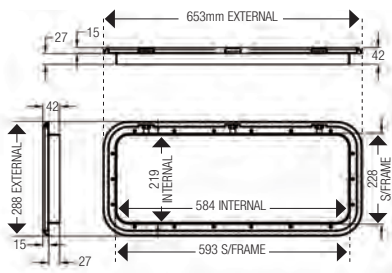

600-00032
COAST DOOR 7 (BLACK)

Suitable for installation on the 'closed' side of the caravan.

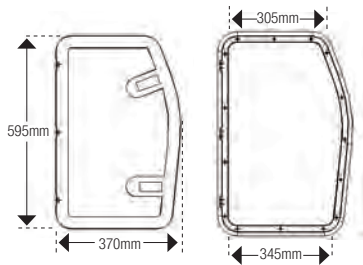

600-00034
COAST DOOR 8 (BLACK)

Suitable for installation on the 'entry' side of the caravan.

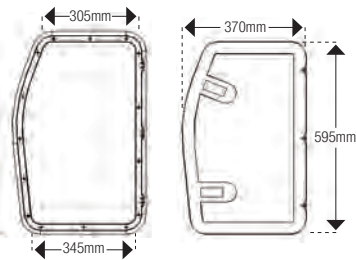

600-00036
COAST DOOR 9 (BLACK)

Has two locks and two sets of keys.

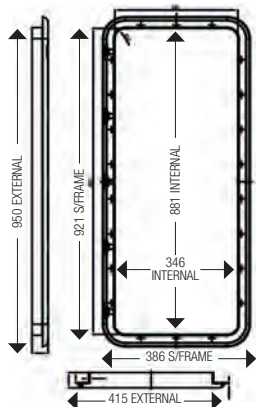

600-00038
COAST DOOR 10 (BLACK) TUNNEL BOOT DOOR

Has two locks and two sets of keys.

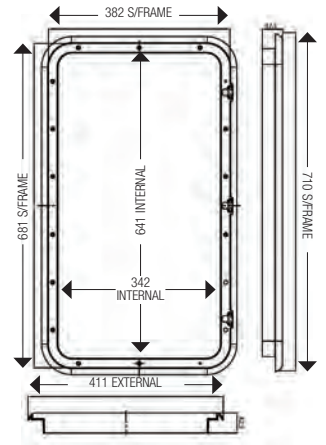

600-00357
WHITE DOOR LOCK

Sold as a single lock with a set of keys. Suitable for use on Coast Access Doors



600-00359
CHROME DOOR LOCK

Sold as a single lock with a set of keys. Suitable for use on Coast Access Doors



600-09002
HINGE ONLY FOR DOORS 1 THROUGH 12 - WHITE (MR500-111)

600-09002
HINGE ONLY FOR DOORS 1 THROUGH 12 - BLACK

GRAB HANDLES

600-00120
WHITE CARAVAN PLASTIC GRAB HANDLE - MODEL 86

This is a sturdy plastic handle designed to act as a convenient grabbing point on corners of RVs.



COAST GRAB HANDLES

Coast Grab Handles are made from lightweight and durable stainless steel and are ideal for both internal and external RV use.

Available in four convenient sizes in both stainless steel or matte black finishes, the range is well suited to accommodate most needs. Each grab handle comes equipped with a fixing kit for secure DIY mounting and features a knurled steel gripping surface for safe and convenient use.



They are a perfect fit for the entry way to your RV or even as a front or rear gripping point for manually moving a van around.

600-00170
COAST 350MM STAINLESS STEEL CARAVAN GRAB HANDLE - 32MM (D) 350MM (L)

600-00172
COAST 400MM STAINLESS STEEL CARAVAN GRAB HANDLE - 32MM (D) 400MM (L)

600-00174
COAST 500MM STAINLESS STEEL CARAVAN GRAB HANDLE - 32MM (D) 500MM (L)

600-00176
COAST 600MM STAINLESS STEEL CARAVAN GRAB HANDLE - 32MM (D) 600MM (L)

600-00180
COAST 350MM MATT BLACK STAINLESS STEEL CARAVAN GRAB HANDLE - 32MM (D) 350MM (L)

600-00182
COAST 400MM MATT BLACK STAINLESS STEEL CARAVAN GRAB HANDLE - 32MM (D) 400MM (L)

600-00184
COAST 500MM MATT BLACK STAINLESS STEEL CARAVAN GRAB HANDLE - 32MM (D) 500MM (L)

600-00186
COAST 600MM MATT BLACK STAINLESS STEEL CARAVAN GRAB HANDLE - 32MM (D) 600MM (L)

PLASTIC GRAB HANDLES

These grab handles are sleek with a robust design. Available in white or black, they are easy to install. It involves a simple process of attaching the handle with four screws. Once done, the screws can then be covered up using the end caps provided.

SPECIFICATIONS

Dimensions: 170L x 45W (mm)

600-02000
WHITE PLASTIC GRAB HANDLE



600-02010
BLACK PLASTIC GRAB HANDLE



600-02030
LED GRAB HANDLE BLACK (12V)

Add some style to an RV entry with this grab handle. It has a blue glow that can be turned on or off via a red button. It is also simple to attach with two screws and two gaskets.

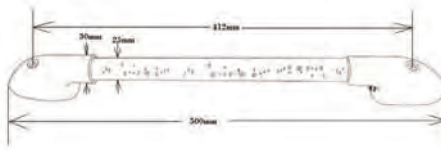

CABIN HOOKS

600-00148
CHROME CABIN HOOK 75MM



600-00150
CHROME CABIN HOOK 100MM



600-00152
CHROME CABIN HOOK 150MM



600-00154
CHROME CABIN HOOK 200MM



600-00160
EYE TO SUIT CHROME CABIN HOOK



600-00162
RETAINER FOR CABIN HOOK

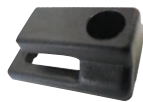

THETFORD SERVICE DOORS

850-01600
SERVICE DOOR TO SUIT THETFORD CASSETTE - WHITE

SPECIFICATIONS

Total Dimensions: 385H x 340W (mm)
Door Opening Dimensions: 330H x 280W (mm)

NZ #850-91000N



850-01601
SERVICE DOOR (#3) TO SUIT THETFORD CASSETTE - BLACK

SPECIFICATIONS

Total Dimensions: 385H x 340W (mm)
Door Opening Dimensions: 330H x 280W (mm)



600-00200
THETFORD SERVICE DOOR #4

Great for gas cylinders and water tanks. Has two push button latches with locks and is available in white.

SPECIFICATIONS

Total dimensions: 700H x 395W (mm)
Door opening dimensions: 630H x 330W (mm)

NZ #850-91010N



600-00201
THETFORD SERVICE DOOR #4 (BLACK)

Great for gas cylinders and bbq's. Has two pushbutton latches with locks and is watertight and UV resistant.

SPECIFICATIONS

Total dimensions: 700H x 395W (mm)
Door opening dimensions: 630H x 330W (mm)



600-00210
THETFORD SERVICE DOOR #5

Great for water tanks and as a general luggage door. Has two push button latches with locks and is available in white.

SPECIFICATIONS

Total dimensions: 785H x 340W (mm)
Door opening dimensions: 730H x 280W (mm)

NZ #850-91020N



600-00211
THETFORD SERVICE DOOR #5 (BLACK)

Great for water tanks and as a general luggage door. Has two pushbutton latches with locks and is watertight and UV resistant.

SPECIFICATIONS

Total dimensions: 785H x 340W (mm)
Door opening dimensions: 730H x 280W (mm)



600-00220
THETFORD SERVICE DOOR #6

Great as a luggage door or for larger objects. Has three push button latches with locks and is available in white.



SPECIFICATIONS

Total dimensions: 1038H x 465W (mm)
Door opening dimensions: 980H x 400W (mm)

NZ #850-91030N

600-00221
THETFORD SERVICE DOOR #6 (BLACK)

Great for large luggage or bulkier items. Has three pushbutton latches with locks and is watertight and UV resistant.



SPECIFICATIONS

Total dimensions: 1038H x 465W (mm)
Door opening dimensions: 980H x 400W (mm)

600-00299
THETFORD HINGE PIN FOR SERVICE DOORS 3, 4 AND 5



600-00231
THETFORD SERVICE DOOR #7

Service Door 7 is perfect for access to a storage area for large objects, like the camping table and chairs or to use as general luggage door.



SPECIFICATIONS

Total dimensions: 1108 x 346 (mm)
Door opening dimensions: 1051 x 282 (mm)

600-00233
THETFORD SERVICE DOOR #7 (BLACK)

Service Door 7 is perfect for access to a storage area for large objects, like the camping table and chairs or to use as general luggage door.



SPECIFICATIONS

Total dimensions: 1108 x 346 (mm)
Door opening dimensions: 1051 x 282 (mm)

600-00450
WHITE BAGGAGE DOOR CATCH

ABS plastic catches keep baggage compartments open while loading and unloading for easy access. Easily mounts directly on RV. (Pack of 2)



600-00510
PUSH BUTTON CATCH MINI

Has a 20mm ring. Please order 600-00512 and 600-00522 and 600-00524/600-00516 to make a complete kit.



600-00512
STRIKER PLATE NICKEL ANGLED

Please order 600-00510 and 600-00522 and 600-00524/600-00516 to make complete kit.



600-00520
PUSH BUTTON LOCK (BROWN)

A larger version of 600-00510.



SPECIFICATIONS

Dimensions: 35L x 48H x 20D (mm) and has a 25mm ring.

600-00522
PUSH CATCH ROSETTE ONLY NICKEL 19MM

Please order 600-00510, 600-00512 and 600-00524 to make a complete kit.



600-00524
PUSH BUTTON CATCH KNOB ONLY NICKEL 19MM

Please order 600-00510, 600-00512 and 600-00524 to make a complete kit.



600-00526
PUSH CATCH ROSETTE ONLY GOLD 19MM



600-00528
PUSH BUTTON CATCH KNOB ONLY GOLD 19MM



600-00530
PUSH BUTTON KNOB ONLY
NICKEL 23MM



MILENCO COLUMBIA DOORS

Feel safer on your next adventure with the Columbia door, an attractive caravan entrance door built with safety in mind.

650-00654
MILENCO MEDIUM COLUMBIA DOOR
- WHITE/BLACK FRAME RH
(1750 X 622MM)



650-00655
MILENCO MEDIUM COLUMBIA DOOR
- BLACK/BLACK FRAME RH
(1750 X 622MM)



650-00656
MILENCO MEDIUM COLUMBIA DOOR
- WHITE/BLACK FRAME LH (1750 X 622MM)

650-00657
MILENCO MEDIUM COLUMBIA DOOR
- BLACK/BLACK FRAME LH (1750 X 622MM)

650-00658
MILENCO LARGE COLUMBIA DOOR
- BLACK/BLACK FRAME RH (1850 X 622MM)

650-00659
MILENCO LARGE COLUMBIA DOOR
- BLACK/BLACK FRAME LH (1850 X 622MM)

CAMEC DOOR LOCKS

600-00690
MAIN DOOR LOCK
(LEFT HAND)
 Suitable for use with Camec's 3-point, left hinged main door.



600-00692
MAIN DOOR LOCK
(RIGHT HAND)
 Suitable for use with Camec's 3-point, right hinged main door.



600-00694
MAIN DOOR LOCK (INNER HANDLE KIT)
 Suitable for use with Camec's 3-point door lock, comes with the spindle and screw.

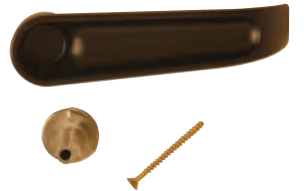

600-00696
MAIN DOOR LOCK (OUTER HANDLE KIT)
 Suitable for use with Camec's 3-point door lock, comes with the outer handle and torsion spring.



600-00699
CAMEC BARREL & KEY T/S
MAIN DOOR LOCK
 Replacement barrel and key to suit Camec three point main door lock.



PANORAMA DOOR LOCKS

600-00600
PANORAMA DOOR LOCK
COMPLETE



600-00602
PANORAMA DOOR OUTER
LOCK WITH KEYS



600-00604
PANORAMA INNER LOCK
ONLY



600-00702
VALTERRA 4" ACCESS
HATCH BLACK



TRIMATIC DOOR LOCKS

600-00620
TRIMATIC DOOR LOCK
COMPLETE



600-00704
VALTERRA 5" ACCESS HATCH
BLACK



600-00622
TRIMATIC DOOR LOCK OUTER LOCK
WITH KEYS



600-00706
VALTERRA 5" ACCESS
HATCH BLACK



600-00624
TRIMATIC DOOR INNER LOCK
ONLY



WIND OUT WINDOW CONTROL BOXES

600-01100
WOW BOX LARGE R/H

SPECIFICATIONS

Dimensions: 295L x 30W (mm)



600-01110
WOW BOX LARGE L/H

SPECIFICATIONS

Dimensions: 295L x 30W (mm)



600-01120
WOW BOX SMALL R/H

SPECIFICATIONS

Dimensions: 190L x 30W (mm)



VALTERRA ACCESS HATCHES

- > 4" and 5" inner diameter
- > Made of UV resistant ABS material which prevents fading
- > Waterproof seal prevents leakage
- > Replaces existing hatches
- > Hole pattern matches most original hatch rings
- > Provides access to plumbing, electrical, cargo areas and hose compartments
- > Use on your RV, boat, horse trailer and more!

600-00700
VALTERRA 4" ACCESS HATCH
WHITE



600-01130
WOW BOX SMALL L/H

SPECIFICATIONS
Dimensions: 190L x 30W (mm)



600-01140
WOW LINK BOX



600-01150
WOW WINDER HANDLE



600-01160
WOW CORNER INSERT PLASTIC



600-01170
WOW SLIDE LOCK AND LEVER



600-01180
WOW END PLUG



PROTECTOR SHADE STAYS

600-01500
SHADE STAY 100MM



600-01502
SHADE STAY 200MM

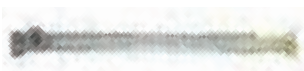

600-01504
SHADE STAY 250MM



DGN HINGES

600-03002
DGN SHORT HINGE FOR TOP AND BOTTOM CUPBOARD C/W SOFT-CLOSE



- > D.G.N. hinges are tested for more than 80.000 opening and closing operations and are lubricated with silicone for a better protection.
- > Has an integrated Soft Close Mechanism making it very quiet and controlled on closing.

600-03004
DGN HORIZ. MOUNT HINGE FOR TOP CUPBOARD W/UPWARD FLAT/CURVED DOOR NO SOFT-CLOSE



- > New and extremely strong hinge from DGN.
- > Has two integrated springs and is protected by an international patent.
- > Its strength means that the locker door will remain perfectly open for years and years.

600-03006
DGN HORIZ. MOUNT HINGE FOR TOP CUPBOARD W/UPWARD FLAT/CURVED DOOR C/W SOFT-CLOSE



- > Heavy duty caravan and RV door hinge.
- > This new hinge has an integrated Soft Close Mechanism making it very quiet and controlled on closing.

600-03010
DGN VERT. MOUNT HINGE FOR TOP CUPBOARD W/UPWARD FLAT/CURVED DOOR C/W SOFT-CLOSE



- > Features spring force regulation that allows the hinge to be mounted on various sized doors.
- > Open angle regulation means the hinge can be set to open to the desired angle.

600-03500
RV SLIDING
DOOR HARDWARE
KIT T/S UP TO
1.83M & 50KG



600-05382
CAMCO PRO-STRENGTH
MILDEW STAIN REMOVER

Safely cleans mildew stains, black streaks, tree sap, tyres, wheel and even grills. It is specially formulated to power away stains caused by mildew in and around your RV. Use it to clean your awning, vinyl cover, chair cushions and many other surfaces. Also great for use on grease, oil and other heavy duty cleaning thanks to its professional strength. Comes in a 946ml spray bottle.



600-05302
CAMCO PRO-STRENGTH BLACK
STREAK REMOVER

A specially formulated cleaner and degreaser that is ready to use and powers away stubborn black streaks resulting from window and door sealants, bugs, tar, grease, oil and dirt that have built up over time, helping to restore a like-new appearance. Not for use on rubber or membrane roofs. Comes in a 946ml spray bottle.



600-05322
CAMCO PRO-STRENGTH WASH
AND WAX

A blend of natural waxes and emulsifiers that will clean, shine and protect your RV in one easy application. It does not require any buffing and thanks to 100% Carnauba Wax being used in its formula, it leaves behind a water resistant surface that promotes a beading action. Safe for use on all finishes. Comes in a 946ml spray bottle.



600-05332
CAMCO PRO-STRENGTH
AWNING CLEANER

Safely removes mould stains, dirt, tree sap and road grime from your awning. It is specially formulated to clean vinyl, nylon, acrylic and fabric awnings, and is also great for use on tents and pop-up campers. Breathe new life into your awning or tent and help restore a like-new appearance. Comes in a 946ml bottle.



5 SECTION CLEANERS

600-05456

COAST CLEANING CLOTH PACK OF 4PCS

This kit of cleaning cloths gives you all the right tools for the job.

Kit Contains

- > Interior Cloth: For keeping your dashboard, vents and all hard interior surfaces free of dust and grime.
- > Glass Cloth: Quickly remove greasy smears, finger marks and grime from windows, mirrors, chrome or polished surfaces.
- > Drying Cloth: A thick microfiber cloth that quickly absorbs water from any surface. Perfect for cleaning the car and wiping away water marks.
- > Suede Cloth: High quality, soft and lightweight ideal for cleaning and polishing delicate surfaces.



600-05500

CAMCO TST PROBE CLEANER

TST Probe Cleaner is a super concentrated liquid that attacks the residue on probes that causes them to malfunction.



HYDROSILEX

600-05672

HYDROSILEX CAMPER

HydroSilex Camper is a revolutionary ceramic surface protection with no limits. It is the first DIY ceramic coating designed for RVs that'll give them a hydrophobic, slick and shiny effect to protect it from the elements.



HydroSilex coats virtually any RV surface such as paint, plastics, glass, metals, gelcoat, etc. Camper will directly bond to the surface and create a smooth and shiny top ceramic layer to protect the surface against the sun, rain, dirt, bird droppings, and any other elements that might tarnish your investment! It provides UV protection to all surfaces, blocking the harsh rays of the sun to stop fading. The lotus effect makes liquids and contaminants bead up and simply roll off the surface.

It's completely DIY with no professional application needed! It'll leave your RV looking new without constant washing, waxing, and buffing. The ceramic coating will outlast any wax or other surface protection and cannot be washed off. You can add more layers for a longer and stronger protection. It's the new way to maintain your RV that saves time, money and effort with amazing results.

It's easy to apply in 3 simple steps:

1. Spray

HydroSilex Camper is a spray on ceramic coating. No mess or grease on hands or anywhere it's not supposed to be.

2. Level

Camper instantly bonds with the surface when it is sprayed on. Just level it after sprayed and the coating stays.

3. Buff

Lightly buff the surface and see it transform to a super hydrophobic slick surface that makes your vehicle shine.

600-05674

HYDROSILEX OFFROAD

The easiest, most effective ceramic coating ever to be applied to the off-road sector! HydroSilex OffRoad can be applied to every exterior surface and will enhance the surface's original shine, protect from the harsh off-road elements as easy as spray and wipe.

This revolutionary DIY ceramic surface protection is specially designed for the off-road environment. Once applied, it gives your RVs surfaces a strong hydrophobic and slick effect that makes maintenance quick and easy, and protects against the dirt, mud, dust, sun and other harsh elements. A simple rinse off is enough to get your RV, ATV, 4x4 or any off-road vehicle back to a brand new look. It also provides UV protection to stop fading and oxidation.



HydroSilex OffRoad will outlast any wax or other surface protection and cannot be washed off. You can add more layers for a longer and stronger protection.

Rest easy knowing HydroSilex OffRoad is working while you play!

600-05684**HYDROSILEX REWIND**

Get your RV, 4x4 or other vehicle perfectly prepped before applying your ceramic coating! HydroSilex Rewind removes any grease, oil or wax residue to decontaminate the surface for bonding.



HydroSilex Rewind is a wax and grease remover ideal to use prior to installing HydroSilex ceramic coatings. For the ceramic coating to bond properly, the surface needs to be clean from any wax residue. After washing the car, use Rewind to strip the surface from any wax or grease that may have been part of the wash soap. The surface is then prepared perfectly for OffRoad or Camper.

To apply: Spray Rewind onto the surface of a clean car. Use high-quality clean microfiber towels and buff free of residue. Ensure you don't apply while in direct sunlight.

600-05690**HYDROSILEX MICROFIBRE TOWELS - 5 PACK****CARAVAN TOUCH UP PAINT**

A powdercoat professional touch up paint, allowing you to repair minor chips and scratches. It has been formulated to match Colorbond® and powdercoat finishes and is suitable for: roofing, aluminium windows, guttering and down spouts, fencing, caravans/ motorhomes, aluminium and steel doors, gardening equipment, railings and boats.

600-06010**CARAVAN TOUCH UP PAINT VIOLET TONE WHITE - 150G AEROSOL****ROOF SEALER**

Elixir roof coating seals off and provides superior reflectivity helping to lower interior temperatures. It is UV resistant and expands and contracts with the roof.

600-05020**ROOF SEAL 1L WHITE**

Coverage: 5m² p/L
Application: Brush, roller, spray gun
Touch Dry: 1-1.5 hours
Not suitable for rubber roofs

**600-05024****ROOF SEAL 4L WHITE**

Curing Time: 24 Hours
Not suitable for rubber roofs

**DICOR LAP SEALANT****600-05050****DICOR LAP SEALANT FOR RUBBER ROOFS (110Z CARTRIDGE)****600-05052****DICOR LAP SEALANT FOR VERTICAL SURFACES**

Non-sag and non-levelling,
10.3oz cartridge

**600-05100****DICOR RUBBER ROOF REPAIR KIT**

Repair kit includes lap sealant and rubber patch.

SPECIFICATIONS

Patch size: 230 x 250mm

**600-06100****EZYCAULK CAULKING COMPOUND**

Ezycaulk caulking compound 500g tube (white). Caulking butyl rubber sealant is a soft type of non hardening water and dust proofing compound that forms a tough skin but remains permanently soft. Adheres to most common materials i.e. Aluminium, wood, sheet metal and concrete.



5C SILICONE SEALANT

VEC5CLM silicone is suitable for weather proofing, aluminium, concrete, glass and where a premium quality silicone sealant is required as a high movement weather seal. Will accommodate approx 50% movement of the original joint.



600-06110
SILICONE SEALANT VEC5CLM NON ACETIC 370G TUBE GREY

V4 SILICONE SEALANT NON ACETIC

V4 Silicone sealant is a non acetic curing silicone, suitable for aluminium, perimeter glazing, masonry to metal, high movement applications, potable water tanks, plastics etc. Will accommodate approx 35% movement of the original joint.



600-06130
V4 SILICONE SEALANT NON ACETIC 370G TUBE WHITE

V60 SILICONE SEALANT NON ACETIC

V60 Silicone sealant is a non acetic curing silicone, suitable for all types of glazing and waterproofing, structural fin and butt glazing, mirrors, aluminium, metal roofing etc. Will accommodate approx 35% movement of the original joint.



600-06140
V60 SILICONE SEALANT NON ACETIC 300G TUBE CLEAR



600-06142
V60 SILICONE SEALANT NON ACETIC 300G TUBE WHITE

600-06144
V60 SILICONE SEALANT NON ACETIC 300G TUBE BLACK



600-06146
V60 SILICONE SEALANT NON ACETIC 300G TUBE GREY



Z-BOND PLUMBERS ROOF & GUTTER SILICONE

Z-Bond roof and gutter silicone, suitable for sheet metal, aluminium, zincalume, cladding, portable water tanks, etc. Will accommodate approx 25% movement of the original joint.

600-06150
PLUMBERS ROOF AND GUTTER SILICONE 300G TUBE CLEAR



600-06154
BOSTIK 922 IND HIGH TEMP SILICONE ACETIC CURE 300G TUBE TRANSPARENT



Z-BOND NO NAILS CONSTRUCTION ADHESIVE

Z-Bond No Nails construction adhesive is designed for use as an alternative bonding method to nails, screws and rivets etc. No nails is designed for use with wood, plaster board, particle board, masonry, sheet metal, zincalume, wall cladding, ceramics, aluminium, painted surfaces, steel, concrete, brick, floor panels, polystyrene and urethane foam.

600-06160
NO NAILS CONSTRUCTION ADHESIVE 320G TUBE BEIGE



SIMSON ISR

ISR 70-03 is a good compromise between an adhesive and a sealant. Suitable for elastic bonding and sealing in caravan construction. Available in black and white.

- > Solvent, isocyanate- and PVC free.
- > Very good UV-resistance and ageing properties.
- > In general good adhesion on several substrate without the use of a primer.
- > Permanent elastic within temperatures from -40°C to +120°C.
- > Neutral, odourless and fast curing.
- > Paint compatible with most industrial paint- or lacquer systems, both alkyd resin and dispersion based (due to the large scale of different types of industrial paints a paint compatibility test is recommended).
- > Paintable after skin forming (wet on wet); this will not influence the curing speed

600-06170**SIMSON ISR 70-03 BLACK****600-06172****SIMSON ISR 70-03 WHITE****600-06210****STRIP CAULKING**

An ideal sealant for face fixed window flanges, edge moulds etc. It is easily thumbed into place and smoothed with a finger in instances when a soft, non-hardening material is needed. It is waterproof and will not shrink. (Sold per 16' roll - 4.9m)

**TAPE FOAM PVC SEALING**

This general purpose foam tape is manufactured for use in applications requiring positive seals on irregular surfaces or when flex and conformability to tight radius curves are critical considerations.



- > Low density foam is easy to compress and conformable, but is still strong and resilient
- > Insulates against temperature, sound and vibration
- > Formulated from durable Poly Vinyl Chloride (PVC) for long service life.
- > Closed cell structure completely seals out air, moisture, light and dust when compressed at least 30%.

250-02500**GREY 6.4MM THICK
X 12MM X 15.2M****250-02501****BLACK 6.4MM THICK
X 12MM X 15.2M****250-02502****GREY 9.5MM THICK
X 12MM X 7.0M****250-02503****BLACK 9.5MM THICK
X 12MM X 7M****250-02504****GREY 12.7MM THICK
X 12MM X 7.0M****250-02505****BLACK 12.7MM THICK
X 12MM X 7M****250-02506****GREY 6.4MM THICK
X 18MM X 15.2M****250-02507****BLACK 6.4MM THICK
X 18MM X 15.2M****250-02508****GREY 9.54MM THICK
X 18MM X 7.0M****250-02509****BLACK 9.5MM THICK
X 18MM X 7M****250-02510****GREY 12.7MM THICK
X 18MM X 7.0M****250-02511****BLACK 12.7MM THICK
X 18MM X 7M**

650-00070
ELIXIR MINI VENT
 Elixir mini vent 9" x 9"

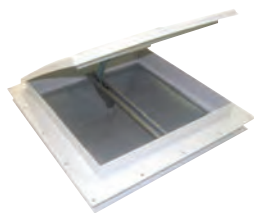

650-00080
VENTLINE 14" X 14" METAL VENT

This vent does not have a fan, but does have an extra strong galvanized steel roof flanges in a painted white finish. It has a screw-in mount, while the dome is styled with an aerodynamic shape in white polypropylene. The screen frame has been designed with stylish radius corners (curved) and comes in two removable pieces which is great for cleaning.

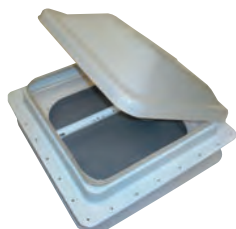

650-00090
VENTLINE 14" X 14" METAL VENT (WITH FAN)

This Ventline Vent has a 12V DC motor making it able to power a fan for faster air delivery. Like 650-00080, it also has extra strong galvanized steel roof flanges in a painted white finish and mounts onto the roof of your RV with screws. The dome is also white with an aerodynamic design. The screen frame also has radius corners and consists of two removable pieces.



SPECIFICATIONS

Cut-out required: 14 1/4" (36.2cm)

REPLACEMENT PLASTIC LID (VENTS)

650-00210
REPLACEMENT PLASTIC LID FOR OLD STYLE JENSEN 14" X 14" VENT

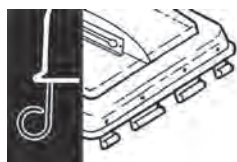
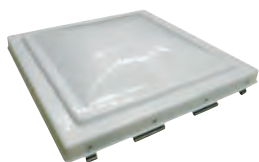

650-00212
REPLACEMENT PLASTIC LID FOR NEW STYLE JENSEN 14" X 14" VENT

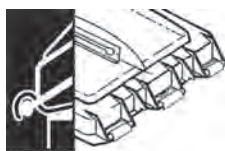
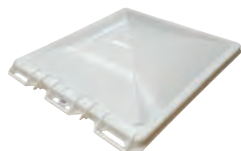

650-00214
JENSEN HATCH 14"X14" BLACK LID ONLY T/S NEW TYPE

Camco's Black Polypropylene Replacement Vent Lid for Jensen with pin hinge is impact-resistant and comes preassembled. It includes all mounting hardware for quick, easy installation on all 14" x 14" RV vents. Hardware is rust resistant.

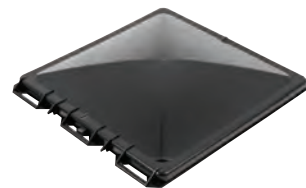

- > Made of durable, impact resistant polypropylene
- > Includes rust-resistant mounting hardware
- > Fits all 14 inch x 14 inch RV vents and replaces Jensen pre 1994 pin style vents
- > Reinforced center bar for added strength and stability
- > Vent lid is pre-assembled for quick and easy installation

650-00230
REPLACEMENT PLASTIC LID FOR OLD STYLE ELIXIR 14" X 14" VENT

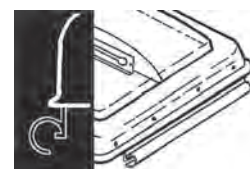
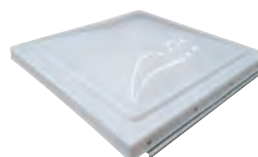

650-00240
REPLACEMENT PLASTIC LID FOR VENTLINE 14" X 14" VENT
 (to suit old metal clip connection)

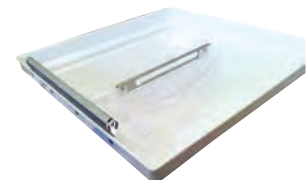

650-00250
VENTLINE VENT REPLACEMENT LID - SMOKE

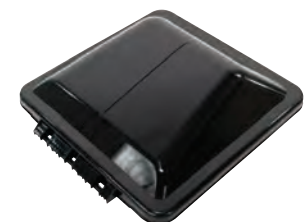

650-00450
VENTLINE REPLACEMENT LID
 White lid only, to suit new style plastic clip connection.



UNIMAXX UNIVERSAL VENT LID REPLACEMENT KIT

Replace damaged or old vent Lids with one, easy-to-install universal vent lid. The Unimaxx universal vent lid takes the hassle out of having to know what year your current lid was manufactured and who manufactured it! Replaces damaged vent lids on Elixir, Hengs, Jensen, Ventline and other roof vent assemblies.

- > Eliminates the need to match hinge types.
- > Preassembled
- > Includes all mounting hardware
- > Uv enforced polypropylene
- > Rust resistant hardware
- > Available in White and Smoke

650-00260 UNIMAXX UNIVERSAL VENT LID REPLACEMENT KIT WHITE



650-00262 UNIMAXX UNIVERSAL VENT LID REPLACEMENT KIT SMOKE



JENSEN SPARES

650-00400 WINDER HANDLE FOR JENSEN HATCH



650-00404 FAN BLADE FOR JENSEN HATCH



VENTLINE SPARES

650-00452 BLACK ELEVATING KNOB
Replacement knob only to open/close the vent lid.



650-00454 VENTLINE 6" FAN BLADE

A plastic fan blade to suit the Ventline 14" x 14" vent.



650-00456 VENTLINE REPLACEMENT FLY SCREEN

With plastic framework and metal mesh, this replacement fly screen suits 14" x 14" Ventline vents with or without a fan.



650-00458 VENTLINE OPERATOR SHORT SHAFT

Suits the old style connection, (spring locking clip with crank).



650-00460 VENTLINE OPERATOR SHORT SHAFT

Suits the new style connection, has a plastic slide clip with crank.



AUSTRALITE FOUR SEASONS HATCH SPARES

650-00554 FOUR SEASONS LIFT MECHANISM



650-00556 FOUR SEASONS HATCH FLY SCREEN

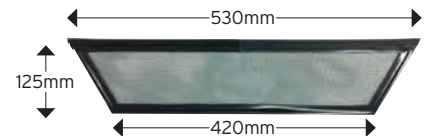

650-00560 INTERNAL FRAME TO SUIT NEW FOUR SEASONS HATCH 50MM
(part number 650-00595)



650-00562

INTERNAL FRAME TO SUIT NEW FOUR SEASONS HATCH - 70MM
(part number 650-00595)



650-00597

AUSTRALITE FOUR SEASONS EVOLUTION HATCH 600 X 600

- > Fully designed and tested in Australia for Australasian conditions
- > Retains Camec's famous 4 season functionality
- > Classic 660x660 square cutout means no change, and also makes it retrofittable to upgrade your old 4 seasons hatch
- > Passive ventilation increased to 223cm² (was 161cm² on previous model)
- > Ergonomic vent controls
- > Each door has three opening positions (closed, rain mode, fully open)
- > New elegant design, matching the 500x700 4 Seasons Evolution Roof Hatch
- > Tough ASA construction resulting in improved sealant adhesion
- > Easy installation from inside the RV
- > Air Deflector integrated into housing.
- > No additional components required.



650-01030

FANTASTIC VENT 4 1/4" WHITE GARNISH

Suitable for use with 5000RBT, 6000RBT, 2250 and 3350.



SPECIFICATIONS

Cut Out Dimensions: 345W x 345D (mm)

650-01064

LID ONLY FOR FANTASTIC VENT "WHITE"



650-01200

DOMETIC DUST REDUCTION SYSTEM

What's the easiest way to keep your caravan clean? Don't let dust enter in the first place! With a rooftop ventilation system like the Dometic Dust Reduction System, you can significantly reduce the amount of dust in your caravan, breathe fresher air and reduce the cleaning time after caravan trips; you don't even need to power it - it works while you drive!



FANTASTIC VENTS

650-01011

FANTASTIC VENT 2250 WITH WHITE ARCHED LID

A ceiling controlled fan with three fan blade speeds. It fits the standard 14" x 14" opening and has a manual lift dome. It operates quietly and features a built-in thermostat, reversible airflow and a high profile base. Comes with a 2yr manufacturer's warranty.



SPECIFICATIONS

Weight: 12lbs (5.4kg)

650-01021

FANTASTIC VENT 3350 WITH WHITE ARCHED LID

A ceiling controlled fan with three fan blade speeds. It fits the standard 14" x 14" opening and has a power lift dome with a manual override in case of emergency. It operates quietly and features a built-in thermostat, reversible airflow, an automatic 'close' function (if the rain sensor gets wet) and a high profile base. Comes with a 2yr manufacturer's warranty.



SPECIFICATIONS

Weight: 12lbs (5.4kg)

FEATURES

- > Stylish Airflow Grille. The grille allows airflow through the unit and prevents debris from entering the vehicle.
- > Modern Design. Modern rooftop unit with a low profile and lightweight design
- > Easy to Use. Changing the air filter is simple thanks to the ceiling cover that is easy to open and close
- > Versatile Installation. Simple and clean design that can be installed in a range of rooftop openings from 285 x 285 mm to 400 x 400 mm
- > Replaceable Air Filters. Additional PM10 air filters sold separately.

SPECIFICATIONS

Dimensions (mm): D473 x H245 x W444

Net Weight: 5kg

Ventilation opening: 150.00cm²

650-02012

FIAMMA ROOF HATCH 160

With an elegant and aerodynamic design, the Roof Hatch 160 is quiet, thanks to the new outside cover and rubber seal. Its watertight system guarantees rain streams down without the possibility of it coming in. Made with quality UV-resistant material, it also features an adjustable centre support arm. Can be installed on roofs with depths from 25-50mm. Supplied with a permanent airflow system and mosquito net.



SPECIFICATIONS

Required cut-out dimensions: 390 x 390 (mm)

650-02019

FIAMMA TURBO VENT 160

Installs in 380mm - 400mm openings with 300mm 10 Blade 12V Fan with polar control thermostat.



650-02030

FIAMMA KOMBI 50CM X 50CM HATCH WHITE

Opening on all four sides with convenient handles, the Kombi Hatch maintains constant RV ventilation. It is available with a roller blind which has a dark roller and a mosquito screen.

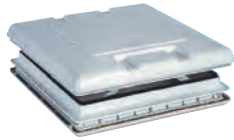

650-02204

FIAMMA WHITE LID FOR VENT 50X50 (98683-118)

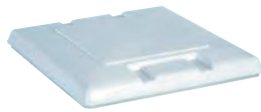

650-02356

FIAMMA VENT 50X50 OUTER FRAME WITH RIGHT AND LEFT ARMS



VENT 28 F AND TURBO-VENT KIT 28 F

The new 28cm x 28cm roof light is perfect for small rooms, ensuring improved interior light. The discreet and elegant design of the internal frame makes it suitable for any environment and the aerodynamic shape does not require the use of the spoiler.

Equipped with permanent ventilation and robust aluminium mosquito net. Thanks to the Sandwich System mounting system, it is not necessary to drill any further holes in the roof of the vehicle. Can be accessorised with the optional Kit Turbo Vent 28 F for motorising the roof light.

FEATURES

- > Greater light and visibility
- > More aerodynamic
- > Complete with double layer cover
- > Equipped with fixed mosquito net
- > Sandwich system installation
- > Optional motorized ventilation kit

650-02065

FIAMMA VENT 28 F WHITE

650-02067

FIAMMA VENT 28 F CRYSTAL

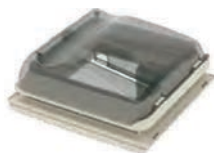

SPECIFICATIONS

Dimensions: 28 x 28 cm
 Outside dimensions: 32 x 34 cm
 Internal dimensions: 31 x 34 cm
 Inside light: 25 x 25 cm
 Roof thickness (min - max): 2,8 - 6,0 cm
 Permanent air flow: 80 cm²

650-02069

FIAMMA TURBO VENT KIT T/S 28 F



SPECIFICATIONS

Voltage: 12 V
 Absorbed power: 25 W
 Max electric input: 1,9 A
 Max air flow: 9 m³/min
 Fan diameter: 180 mm
 Permanent air flow: 50 cm²

FIAMMA HATCH SPARE PARTS

650-02200

STANDARD LID FOR FIAMMA 14" X 14" HATCH



650-02202

LID 160 FOR FIAMMA 14" X 14" HATCH

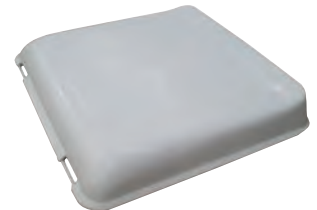

650-02208

FIAMMA WHITE LID ONLY T/S VENT 28

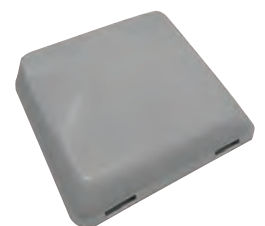

650-02210

HANDLE EXTENSION KIT FOR FIAMMA STD. 14" X 14" HATCH



650-02214
WINDING ARM ONLY
FOR FIAMMA
14" X 14" HATCH



650-02216
WINDING HANDLE KIT ONLY
FOR FIAMMA TURBO VENT 1



650-02222
FIAMMA UNIVERSAL KNOB &
EXTENSION KIT

This universal extension kit allows Fiamma vents to be installed on thicker roofs with thicknesses from 3-8.5cm.



650-02315
FIAMMA ROLLO VENT 40

A roller blind system that is suitable for use on Fiamma 40cm x 40cm vents. It is fixed to the existing vent frame using the screws provided and still allows for permanent ventilation thanks to its side inlets.



Specifications

Weight: 0.1kg

650-99000N
FIAMMA ROOF HATCH VENT 160
(CRYSTAL LID)

Made from quality UV-resistant material, the Crystal Roof Hatch provides permanent airflow ventilation and has a mosquito screen to keep out the bugs. It has an aerodynamic design so a spoiler is not required for installation. The outer cover has an exclusive, patented rubber seal which guarantees a watertight system. It is interchangeable with older 40 x 40 cm Fiamma roof lights, as well as 36 x 36 (cm) - 42 x 42 (cm) roof lights thanks to the reinforced frame. To block out the sun, the Fiamma Rollo Vent 40 can be purchased.



Specifications

Weight: 2.8kg

MAXXAIR VENTILATION SYSTEMS

RV ventilation has never been easier than with a MaxxFan. They've been used in the US RV market since 1988, and they are now exclusively available from Coast to Coast. The MaxxFan Plus and the MaxxFan Deluxe, both have a manual option and an electric opening option, and they also have a ceiling mounted control panel that is easy to use and read.



Removable Flyscreen



Twin Lifting Arms

Some other features include:

- > Removable flyscreen - simply twist the L-clamps and remove for cleaning!
- > Installs onto all standard 14" x 14" (356mm x 356mm) roof openings
- > Powerful 10-speed fan motor
- > Fan can run even if the lid is closed (select 'Ceiling Fan Mode') and can be used in "intake" and "exhaust" modes
- > Provides over 900CFM, keeping your RV cool and comfortable
- > Twin lifting arms limit vibrations cause by wind when in the 'open' position

650-03010
MAXXFAN PLUS
WITH THERMOSTAT
AND MANUAL LIFT



SPECIFICATIONS

| | |
|---------------------|--------------------------|
| Amp Draw on High | 2.6A |
| Amp Draw on Low | 0.17A |
| Dimensions (closed) | 461L x 420W x 97H (mm) |
| Dimensions (open) | 461L x 420W x 311H (mm) |
| Installed Weight | 4.1kg |
| Roof Thickness | 50mm (min) - 110mm (max) |

650-03012
MAXXFAN PLUS WITH
THERMOSTAT, POWER
LIFT, RAIN SENSOR
AND REMOTE



SPECIFICATIONS

| | |
|---------------------|--------------------------|
| Amp Draw on High | 2.6A |
| Amp Draw on Low | 0.17A |
| Dimensions (closed) | 461L x 420W x 97H (mm) |
| Dimensions (open) | 461L x 420W x 311H (mm) |
| Installed Weight | 4.1kg |
| Roof Thickness | 50mm (min) - 110mm (max) |

650-03014
MAXXFAN DELUXE
WITH RAIN DOME,
THERMOSTAT AND
MANUAL LIFT



SPECIFICATIONS

| | |
|---------------------|-------------------------|
| Amp Draw on High | 2.5A |
| Amp Draw on Low | 0.16A |
| Dimensions (closed) | 589L x 421W x 128H (mm) |
| Dimensions (open) | 589L x 421W x 230H (mm) |
| Installed Weight | 5.4kg |
| Permanent Airflow | 82cm ² |
| Roof Thickness | 25mm (min) - 90mm (max) |

650-03016
MAXXFAN DELUXE
WITH RAIN DOME,
THERMOSTAT, POWER
LIFT AND REMOTE



SPECIFICATIONS

| | |
|---------------------|-------------------------|
| Amp Draw on High | 2.5A |
| Amp Draw on Low | 0.16A |
| Dimensions (closed) | 589L x 421W x 128H (mm) |
| Dimensions (open) | 589L x 421W x 230H (mm) |
| Installed Weight | 5.4kg |
| Roof Thickness | 25mm (min) - 90mm (max) |

650-03018
MAXXFAN DELUXE -
SMOKE RAIN DOME,
T/STAT, POWER
LIFT AND REMOTE.
356X356MM



SPECIFICATIONS

| | |
|---------------------|-------------------------|
| Amp Draw on High | 2.5A |
| Amp Draw on Low | 0.16A |
| Dimensions (closed) | 589L x 421W x 128H (mm) |
| Dimensions (open) | 589L x 421W x 230H (mm) |
| Installed Weight | 5.4kg |
| Roof Thickness | 25mm (min) - 90mm (max) |

650-04000
AERO FLO VENT COVER FOR 14"
X 14" ROOF VENT



Get high flow fresh air ventilated throughout your RV in rain or sunshine. It has a swing open top for easy cleaning and because it has vents on three sides it has 30% more open vent area than some other vent covers. Made from UV stabilized resin it mounts easily to existing 14" x 14" roof vents.

650-04020
MAXXAIR STANDARD VENT
COVER



THE MAXXAIR ORIGINAL VENT COVER. Lets in FRESH AIR ANY TIME... Rain or Shine!

- > Prevents Heat Buildup in your RV
- > Proven SUPER-TOUGH one piece design
- > Mounts to all existing 14" x 14" roof vents INCLUDING the new Ventline E-Z Lift Ventadome

Not recommended for High-Powered Fans like MAXXFAN, MAXXFAN Plus Fans, ShurFlo Fan or Fantastic Fan.

SKYMAXX & SKYMAXX PLUS



Natural light and fresh air - the basic fundamentals to the richness of our individual lives and our unique living environments. Light and fresh air create within us a variety of moods that often make any surrounding an oasis.

While enjoying time with family, neighbours or just simply relaxing, MAXXAIR's new SKYMAXX Series of skylights can add so much function, drama, balance and ventilation to any environment.

Features

- > Natural light makes small spaces feel open and free.
- > Create drama in any space.
- > Bring the balance and harmony of nature indoors.
- > With the ability to open the SKYMAXX, create a cooling effect and bring fresh air throughout your RV.
- > Create more opportunities for natural light without sacrificing privacy.

The SKYMAXX is available in two sizes: SKYMAXX and SKYMAXX LX. Both sizes are offered with or without 12V LED accent lighting. All models come with a screen and shade that can either be:

- > Fully Open
- > Screen Only
- > Shade Only
- > 1/2 Shade and 1/2 Screen

SKYMAXX AND SKYMAXX PLUS

FEATURES

- > Skymaxx - Non-LED
- > Skymaxx Plus - LED
- > Manual lift with 3 open positions
- > Pleated screen & shade provides options of full sun-full shade, partial sun/shade
- > Fits 15.75" x 15.75" (400mm x 400mm) opening
- > Sized for 0.90" to 2.36" (23mm to 60mm) roof thicknesses with no cutting required
- > Optional passive ventilation
- > White interior frame
- > LED operates on 12 VDC, 2 amp service
- > RoHS compliant

650-03020
SKYMAXX 400 X 400MM SKYLIGHT WITH INTERNAL BLIND (23/60MM)

650-03022
SKYMAXX PLUS 400 X 400MM SKYLIGHT WITH INTERNAL BLIND & LED (23/60MM)



Fully Open Screen Only Shade Only



Features

- > Skymaxx LX - Non-LED
- > Skymaxx LX Plus - LED
- > Manual lift with 4 open positions
- > Pleated screen & shade provides options of full sun-full shade, partial sun/shade
- > Fits 27.5" x 19.70" (700mm x 500mm) opening
- > Sized for 0.90" to 2.36" (23mm to 60mm) roof thicknesses with no cutting required
- > Optional passive ventilation
- > White interior frame
- > LED operates on 12 VDC, 2 amp service
- > RoHS compliant

650-03026

SKYMAXX LX 700 X 500MM SKYLIGHT WITH INTERNAL BLIND (23/42MM)

650-03028

SKYMAXX LX PLUS 700 X 500MM SKYLIGHT WITH INTERNAL BLIND & LED (23/42MM)

650-03030

SKYMAXX LX 700 X 500MM SKYLIGHT WITH INTERNAL BLIND (42/60MM)

650-03032

SKYMAXX LX PLUS 700 X 500MM SKYLIGHT WITH INTERNAL BLIND & LED (42/60MM)



Fully Open

Screen Only

Shade Only

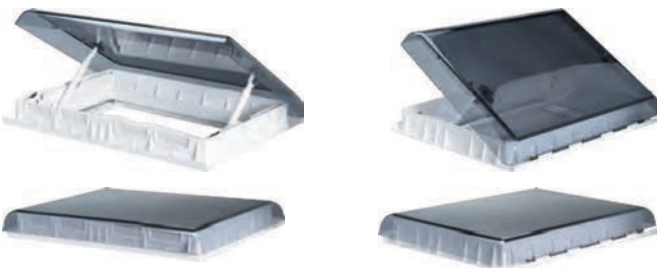

650-04030

CAMCO LIGHTS OUT RETRACTABLE RV ROOF VENT SHADE

Camco RV Cream Retractable Lights Out Vent Shade prevents light from shining into RV sleeping quarters at night. Easily mounts to ceiling and retracts into the space-efficient housing to allow light inside during the day. Opens to 14-1/8" x 19". Durable, lightweight vinyl's reflective finish reflects heat to keep RV cool.



- > Easy installation
- > Reflects heat to keep the RV cool
- > Opens to 14-1/8" x 19"
- > Prevent light from shining into RV at night
- > Easily retracts to let light in during the day

650-04100

MULLER WHITE PVC EXTERIOR VENT

Muller White PVC Exterior Vent



650-04110

ROTARY VENT PLASTIC WHITE

Manufactured from high grade plastic (abs), exceptional on transportation vehicles such as buses, RV's, animal transport vehicles, delivery vans and marine vessels. Has a corrosion resistant stainless steel centre shaft.



SPECIFICATIONS

Dimensions: 240D x 120H (mm)

650-04150

SCUPPER VENT WHITE (SMALL)

Powder coated aluminium in white with one spring.

SPECIFICATIONS

Dimensions: 170L x 112W (mm)



650-04160
SCUPPER VENT INTERNAL
FRAME PLASTIC
Suitable for use with the small vent only (i.e. with 650-04150).

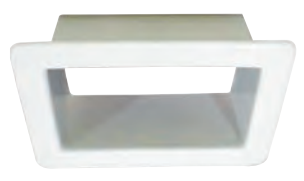

650-04170
SCUPPER VENT WHITE
(LARGE)
Powder coated aluminium in white with two springs.



SPECIFICATIONS
Dimensions: 242L x 149W x 20H (mm)

650-04175
SCUPPER VENT INTERNAL
FRAME FOR LGE VENT



650-04178
SCUPPER VENT REPAIR KIT FOR SMALL VENT

650-04179
SCUPPER VENT REPAIR KIT FOR LARGE VENT

SECTION

6

MAJOR APPLIANCES

(Product Group - 700)

| | |
|---------------------------------------|-----------|
| Rangehoods | 234 |
| Washing Machines and Spare Parts | 235 - 237 |
| Fridge Fans | 238 |
| Waeco Refrigeration | 239 - 240 |
| Dometic Refrigeration and Accessories | 240 - 242 |
| Thetford Refrigeration | 243 - 245 |
| Thetford Cooking Appliances | 246 - 250 |
| Dometic Cooking Appliances | 251 |
| Lido Stoves | 251 |
| Barbeques | 252 - 253 |
| Sphere Microwave | 253 |
| My Coolman Fridges | 254 - 255 |



DOMETIC RANGEHOODS

700-00100
CK150 RANGEHOOD 12V
FLUSH MOUNT



700-00110
CK155 RANGEHOOD 12V
SURFACE MOUNT



SPHERE™ RANGEHOODS (12V)

Cooking in confined spaces can sometimes create unwanted scents and condensation on your RV's splashback. By installing a rangehood, hot and foul smells are quickly extracted up and out of your RV. Comprising of three models, the rangehoods are easy to install thanks to their compact size. This range features an LED lighting strip and easy to remove filters (for cleaning).

700-06200
SPHERE™ TOUCH CONTROL

Features a tempered glass front panel with an LCD display and a stainless steel body. Suitable for installation underneath a cupboard.



SPECIFICATIONS
 Dimensions: 530W x 304D x 60H (mm)
 Air Flow: 100m³/hr
 Total Input: 35W

700-06213
SPHERE™ TEMPERED
GLASS FACE RECESSED
RANGEHOOD

Cooking in confined spaces can sometimes create unwanted scents and condensation on your RV splashback. By installing a range hood, hot air and smells are quickly extracted up and out of your RV - much quicker than by just opening a window or door.



- FEATURES**
- > Tempered glass front
 - > Zinc Steel Construction
 - > LED strip light
 - > Rocker Switch Control
 - > Black 5 Layer Aluminium Filter

SPECIFICATIONS
 Power: 12 Volt DC
 Rated Power Input: 35W
 Illumination: 1 x 3W LED Lamp Strip
 Max Airflow: 120 m³/hr
 No. of Motor: 2
 Motor Rated Power: 2 x 16W

SPHERE™ AUTOMATIC MINI WASHING MACHINES



Take caravan and camping trips to a new level of comfort and convenience with the Sphere 3.5kg 12V Automatic Washing Machine. Off the grid automatic washing has never been easier! The need to wait your turn to use the caravan park laundry is over because you're now able to do your laundry when it is convenient for you and all with power from your onboard battery system! An Anderson plug comes included as standard to allow for a quick and simple connection. The Sphere Automatic Mini Washing Machine has five process settings from a wash-rinse-spin cycle (lasting approx. 38mins) to a simple spin cycle (lasting approx. 7mins). Wash settings are set via the uncomplicated control panel. This washing machine is suitable to cold wash only but has the adaptability of having the drainage hose outlet on either the left or right side of the machine. With an elegant white body and stainless-steel wash tub, it will fit the interior decor of any RV.

700-00352 AUTO MINI WASHING MACHINE (2.6KG)

SPECIFICATIONS

Power Supply: 240V/50Hz
Max Water Volume: 20L
Weight: Gross - 18kg, Net - 16kg
Dimensions: 410W x 420D x 640H (mm)



700-00364 12V AUTO MINI WASHING MACHINE (3.5KG)

- > Has a newly designed carry basket with locking clips
- > Has an 'out of balance' sensor
- > Stainless steel wash tub
- > Now features rubber hoses with stainless steel "screw" clamps
- > Durable lint filter similar to domestic standards
- > has time display shows time remaining in the cycle or in event of an error, it shows the fault code
- > Has an Auto Power Off function - at the end of your selected washing cycle, a buzzer will sound up to six times before turning the power off
- > You can select your water level usage (depending on your load size), which saves your water and detergent! The 3.5kg has three level settings



700-00362 AUTO MINI WASHING MACHINE (3.3KG)

SPECIFICATIONS

Power Supply: 240V/50Hz
Max Water Volume: 26L
Weight: Gross - 20kg, Net - 18.5kg
Dimensions: 410W x 420D x 740H (mm)

SPECIFICATIONS

Load Capacity: 3.5kg (dry laundry)
Power Supply: 12V DC
160W Wash Power/130W Spin Power
3.3amps per wash (approx. 30 washes from 100 AH battery)
Max Water Volume: 26L Net
Inlet hose: Cold connection only
Max water usage: 78L per load (on high setting)
Cold water only
Weight: 18.5kg
Dimensions: W410mm x D420mm x H740mm (+ 240mm with lid up)

6 SECTION

WASHING MACHINE SPARES

700-00800
SPHERE™ WASHING MACHINE
TOP LID



700-00816
SPHERE WASHING
MACHINE WATER INLET
HOSE



NOT
AVAILABLE IN
NEW ZEALAND

700-00803
SPHERE WASHING MACHINE
WATER LEVEL SENSOR

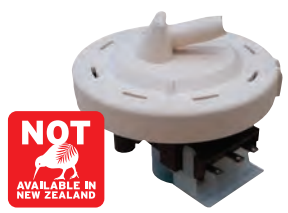

NOT
AVAILABLE IN
NEW ZEALAND

700-00817
SPHERE WASHING
MACHINE PLASTIC BASKET
FOR LINING



NOT
AVAILABLE IN
NEW ZEALAND

700-00806
SPHERE WASHING
MACHINE SPRING



NOT
AVAILABLE IN
NEW ZEALAND

700-00818
SPHERE WASHING MACHINE
UP DRAIN HOSE



NOT
AVAILABLE IN
NEW ZEALAND

700-00807
SPHERE WASHING MACHINE SAFETY
SWITCH



NOT
AVAILABLE IN
NEW ZEALAND

700-00819
SPHERE WASHING MACHINE PUMP

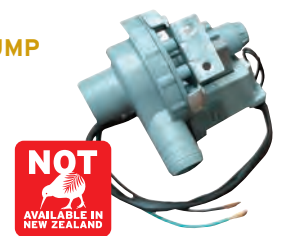

NOT
AVAILABLE IN
NEW ZEALAND

700-00810
SPHERE WASHING MACHINE
LINT
FILTER KIT



NOT
AVAILABLE IN
NEW ZEALAND

700-00822
SPHERE WASHING
MACHINE CONNECT
RUBBER HOSE



NOT
AVAILABLE IN
NEW ZEALAND

700-00812
SPHERE WASHING MACHINE
V-BELT



NOT
AVAILABLE IN
NEW ZEALAND

SPHERE ECOSPIN PORTABLE WASHER



Sphere EcoSpin Portable Washer is a hand-powered spin cycle clothes washer. Gentle on clothes this Eco-friendly laundry option is the perfect choice for when you're off the beaten trail.

The Sphere EcoSpin Portable Washer can wash up to 2L of laundry in just minutes. This time and money saver requires no electricity and uses less water and detergent than traditional washing machines. Its clever design is gentle on clothes, there are no protruding elements to cause damage like other hand powered washers. It takes less effort to spin compared to other hand powered washers and the EcoSpin can even spin dry your clothes so they dry faster on the line.

The lightweight, highly portable Sphere EcoSpin portable washer is the perfect option for free camping, caravanning and fishing.

700-00370

SPHERE ECOSPIN PORTABLE WASHER

FEATURES

- > Easy to use
- > Compact and sturdy design
- > Tight locking lid
- > Fold down crank handle
- > Directional drainage hose
- > Four feet for excellent grip
- > 1 Year Warranty

SPECIFICATIONS

Dimensions: 345 x 344 x 343mm

Load capacity: 2L

Wash time: 2 minutes

Spin time: 30 seconds



700-01050
FRIDGE FAN (SOLAR)



NOT
AVAILABLE IN
NEW ZEALAND

700-01100
CAMCO REFRIDGERATOR
VENT COVER TOP ONLY



NOT
AVAILABLE IN
NEW ZEALAND

700-01102
CAMCO REFRIDGERATOR
VENT BASE



NOT
AVAILABLE IN
NEW ZEALAND

WAECO ADAPTERS

700-02402
WAECO 110 - 240V AC TO
24V POWER ADAPTER
(MPS-50A)

Suits all Waeco CDF and CF models, has an output current of 6A.



NOT
AVAILABLE IN
NEW ZEALAND

SPECIFICATIONS

Dimensions: 120W x 70H x 200D mm

700-02414
WAECO EPS817A POWER
ADAPTER

A 240V to 12VDC adapter; suitable for use with: CF18, CF25Vera, CDF35Pack and CDF11; also suitable for use with all 12V thermoelectric coolboxes.



NOT
AVAILABLE IN
NEW ZEALAND

SPECIFICATIONS

Dimensions: 115W x 65H x 170D (mm)

700-03000
RV ELECTRONICS FRIDGE
SWITCH

Has an inbuilt electronic movement & vibration sensor which switches the 12v circuit of the caravan's 3-way fridge "on" when the vehicle is moving & turns the fridge "off" when the vehicle stops.



Fridgeswitch has a varying timing circuit which may keep the fridge turned on for up to 3 minutes after the vehicle has stopped. This is to keep the fridge turned on while you are stopped at traffic lights.

- > No more flat batteries when the fridge is left on
- > Only one auxiliary line needed
- > Automatically turns your caravan fridge on and off
- > Easy 15 minute installation

WAECO COOLMATIC CRX FRIDGE FREEZERS

Equipped with energy efficient genuine WAECO compressors, the well-proven WAECO CoolMatic refrigerator series provide outstanding energy efficient refrigeration for built-in mobile applications. Their operation is reliable even in tilted positions and high ambient temperatures. They work economically, quietly and are ideal to run with solar panels.

The various models of the CoolMatic series satisfy all mobile fridge requirements. There's a matching refrigerator for every size of vehicle and for every room situation. With a modern stylish exterior, plus well organised and practical interior, the WAECO CoolMatic CRX range are the logical choice for your caravan, motorhome, yacht or boat.

700-03102 WAECO COOLMATIC CRX 50

SPECIFICATIONS

Storage volume (approx.): 45L
 Freezer compartment: 4.4L
 Voltage: 12/24 V DC
 Average Power Consumption: approx. 40 W
 Current Consumption at 12V: 1.1 Ah/h at +25°C ambient temperature, 1.7 Ah/h at +32°C ambient temperature, both at +5°C interior temperature
 Temperature Range: approx. +12 to -15°C
 Dimensions (W x H x D): 380 x 534 x 447mm
 With Flush-mount Frame: 406 x 536 x 495mm
 With Standard frame: 384 x 536 x 447mm



700-02980 WAECO CR-50 STANDARD MOUNTING FRAME

700-02990 WAECO CR-50 FLUSHMOUNT MOUNTING FRAME

700-03104 WAECO COOLMATIC CRX 65

SPECIFICATIONS

Storage volume (approx.): 57L
 Freezer compartment: 7.0L
 Voltage: 12/24 V DC
 Average Power Consumption: approx. 45 W
 Current Consumption at 12V: 1.4 Ah/h at +25°C ambient temperature, 1.8 Ah/h at +32°C ambient temperature, both at +5°C interior temperature
 Temperature Range: approx. +12 to -15°C
 Dimensions (W x H x D): 448 x 525 x 492mm
 With Flush-mount Frame: 474 x 527 x 540mm
 With Standard frame: 452 x 527 x 492mm
 Without door: 448 x 525 x 492 mm
 Weight (approx.): 19.0 kg



700-02982 WAECO CR-65 STANDARD MOUNTING FRAME

700-02992 WAECO CR-65 FLUSHMOUNT MOUNTING FRAME

700-03106 WAECO COOLMATIC CRX80

SPECIFICATIONS

Storage volume (approx.): 78L
 Freezer compartment: 7.5L
 Voltage: 12/24 V DC
 Average Power Consumption: approx. 50 W
 Current Consumption at 12V: 1.9 Ah/h at +25°C ambient temperature, 2.0 Ah/h at +32°C ambient temperature, both at +5°C interior temperature
 Temperature Range: approx. +12 to -15°C
 Dimensions (W x H x D): 475 x 640 x 475mm
 With Flush-mount Frame: 501 x 642 x 523mm
 With Standard frame: 479 x 642 x 475mm
 Weight (approx.): 21.0 kg



700-02984 WAECO CR-80 STANDARD MOUNTING FRAME

700-02994 WAECO CR-80 FLUSHMOUNT MOUNTING FRAME

WAECO FRIDGES

700-03108 WAECO COOLMATIC CRX110

SPECIFICATIONS

Storage volume (approx.): 104L
 Freezer compartment: 9.0L
 Voltage: 12/24 V DC
 Average Power Consumption: approx. 65 W
 Current Consumption at 12V: 1.8 Ah/h at +25°C ambient temperature, 2.4 Ah/h at +32°C ambient temperature, both at +5°C interior temperature
 Temperature Range: approx. +12 to -15°C
 Dimensions (W x H x D): 520 x 745 x 558mm
 With Flush-mount Frame: 546 x 747 x 606mm
 With Standard Frame: 524 x 747 x 558mm
 Weight (approx.): 26.0 kg



700-03510 DOMETIC RM2350 3-way 90L fridge 12V/240V/gas

SPECIFICATIONS

Dimensions: H 766 x W 550 x D 565mm



700-02986 WAECO CR-110 STANDARD MOUNTING FRAME

700-02996 WAECO CR-110 FLUSHMOUNT MOUNTING FRAME

700-03110 WAECO COOLMATIC CRX140

SPECIFICATIONS

Storage volume (approx.): 130L
 Freezer compartment: 11.0L
 Voltage: 100/24 V AC 12/24 VDC
 Average Power Consumption: approx. 65 W
 Current Consumption at 12V: 1.89 Ah/h at +25°C ambient temperature, 2.5 Ah/h at +32°C ambient temperature, both at +5°C interior temperature
 Temperature Range: approx. +12 to -15°C
 Dimensions (W x H x D): 525 x 815 x 620mm
 With Flush-mount Frame: 551 x 817 x 668mm
 With Standard frame: 529 x 817 x 620mm
 Weight (approx.): 27.5 kg



700-02988 WAECO CR-140 STANDARD MOUNTING FRAME

700-02998 WAECO CR-140 FLUSHMOUNT MOUNTING FRAME

700-12300 DOMETIC RUC 5208X 12/24/240V 153L COMPRESSOR REFRIGERATOR

The Dometic RUC 5208X model is an upright compressor refrigerator that features a narrow cabinet design that allows for greater flexibility in the kitchen area of recreational vehicles without compromising on storage volume.



SPECIFICATIONS

Dimensions: H 1191 x W 550 x D 677mm
 Net Weight: 43.50 kg
 Gross Volume: 153.00L
 Storage Volume: 146.00L
 Fridge Storage Volume: 133.00L
 Freezer Storage Volume: 13.00L

700-12304 DOMETIC RU 8408X ABSORPTION REFRIGERATOR 216L

The Dometic RU 8408X is a single door upright absorption refrigerator that features a narrow cabinet design for greater flexibility in the kitchen area of recreational vehicles without compromising on storage volume.



SPECIFICATIONS

Dimensions: W 677 D x 1657 H x 550
 Net weight: 64kg
 Gross volume: 224L
 Storage volume: 170L
 Fridge Storage Volume: 170L
 Freezer Storage Volume: 46L
 Input Voltage (AC): 230V-240V
 Input Voltage (DC): 12V
 Rated Input Power (AC): 325W
 Rated Input Power (DC): 275W

700-03540

DOMETIC A1625 VENT KIT

Vent kit with T piece for Dometic 3 way refrigerator, suitable for absorption fridges. These are fitted on the outside of the van behind the fridge to allow air flow.

Must order 700-03541 - DOMETIC T PIECE T/S AS1625 (2 PIECE KIT). TP-KIT) to make complete kit.



700-03563

DOMETIC LOWER FRAME T/S AS1625 WHITE



700-03544

DOMETIC LOCKING CLIP FOR A1625 VENT KIT



700-03567

DOMETIC UPPER VENT FLUE INSERT



700-03543

DOMETIC UPPER VENT T/S AS1625 WHITE



700-03580

DOMETIC UPPER FRAME T/S AS1625 BLACK



700-03582

DOMETIC UPPER VENT T/S AS1625 VENT BLACK



700-03548

DOMETIC LS300 VENT KIT (FRAME & GRILL) WHITE



700-03584

DOMETIC LOWER FRAME T/S AS1625 BLACK



700-03549

DOMETIC LS300 VENT KIT (FRAME & GRILL) BLACK

700-03565

DOMETIC UPPER FRAME T/S AS1625 WHITE



700-03586

DOMETIC LOWER VENT T/S AS1625BLACK



700-03564

DOMETIC LOWER VENT T/S AS1625 WHITE



700-03588

DOMETIC UPPER VENT FLUE INSERT BLACK



6 SECTION

DOMETIC SPARES

700-03680
DOMETIC SPRING L/H T/S
RM2330/2310



700-03660
DOMETIC SPRING HOUSING RH
FOR RM2330/2310



700-03691
DOMETIC SPRING R/H T/S
RM2330/2310



700-03662
DOMETIC SPRING HOUSING LH
FOR RM2330/2310



700-03684
DOMETIC FLUE KIT+T-PIECE.
3776



700-03650
DOMETIC ELEMENT 240V 195W
FOR RM2453/RM2553



700-03652
DOMETIC ELEMENT 240V 175W FOR
RM2330/RM2350



THETFORD 3-WAY FRIDGES AND VENTS

For more than 40 years, Thetford has been designing and developing refrigerators for the leisure market. Thetford absorption refrigerators work differently than your fridge at home. Thetford 3-way refrigerators have no compressor, making them much quieter. This means you can relax and enjoy a pleasant stay in your caravan or camper, without noisy appliances buzzing in the background. Not stopping with mere production, Thetford continues to develop and innovate in terms of quality, design and ease of use. Thetford refrigerators are extensively tested to high quality standards, are AGA approved and carry the CE mark. Plus Thetford refrigerators come with a full three year warranty.

700-03772 THETFORD N3141A 140LT SES 3 WAY FRIDGE REVERSIBLE HAND

Thetford Australia proudly introduces a new fridge for the RV market, the N3141-A. The new N3141-A is the ultimate space saver which also offers the best cooling performance. The state-of-the-art LCD display with touch screen and the unique external drawer make the fridge super easy to use.



Specifications

Dimensions Including Depth of Door: 1510H x 439W x 561D (mm)
Total Volume incl. freezer: 141L
Freezer Compartment: 15L
Usable Power Source: DC/AC/Gas
Control Panel: LCD
Door Shape: Flat Framed
Net Weight: 38kg

700-03920

THETFORD 166L SES 3 WAY ELECTRONIC ABSORPTION FRIDGE (N514-E)

- > Larger model (166L gross capacity)
- > Electric display
- > Automatic Energy Selection (SES)
- > AGA (The Australian Gas Association) approved to the latest Australian standards
- > Adjustable thermostat to respond to high ambient temperatures and varied use
- > Flame current meter monitors gas ignition
- > Easy-to-clean, durable white, powder-coated shelves
- > Includes one ice tray
- > Contemporary design with ergonomic controls and latch.



SPECIFICATIONS

Dimensions Including Depth of Door: 1090H x 625W x 640D (mm)
Enclosure Cut-Out Dimensions: 1083H x 602W x 610D (mm)
Total Gross Capacity: 166L (approx.)
Without Freezer Compartment: 144L (approx.)
Freezer Compartment: 20L (approx.)
Usable Power Source: DC/AC/Gas
Energy Consumption 12v/240v: 3.5kWh/24h
Energy Consumption Gas: 17gr/h
Door Shape: Flat / Framed
Net Weight: 40kg
Cooling Fans: 1

THETFORD 171L SLIMLINE N4175 FRIDGE

A large, 175L double-door absorption refrigerator that stays constantly cool. This model with LED control panel guarantees a cabinet temperature that is always perfect regardless the power supply (between 210 and 250V). The desired energy source is selected automatically for this refrigerator.



- > Our refrigerators are extensively tested to high quality standards.
- > First class cooling performance
- > Big and spacious

SPECIFICATIONS

Control panel: LED
 Dimensions incl. depth door (h x w x d): 1245 x 525 x 628 (mm)
 Door shape: Curved framed
 Door type hinging*: Left
 Energy consumption**: 4.0 kWh/24h
 Energy consumption gas**: 420 g/24h
 Energy Selection (or Power source selection): Automatic
 Freezer volume: 31 L
 Net weight: 39.5 Kg
 Refrigerant amount: 126g
 Refrigeration technology: Single pressure absorption refrigerator
 Total volume incl. freezer: 175 L
 Type of refrigerant: Ammonia

700-03922 THETFORD LH 171L SLIMLINE N4175 FRIDGE

700-03924 THETFORD RH 171L SLIMLINE N4175 FRIDGE BLK

700-03902 THETFORD T2152C 152 LITRE SLIM COMPRESSOR FRIDGE

Following the slim refrigerators of only 418 mm wide and the growing interest for compressor refrigeration, Thetford developed the T1152. A powerful 152L compressor refrigerator.



- > Thetford refrigerators are extensively tested to high quality standards
- > First class cooling performance
- > Optimal use of space

SPECIFICATIONS

Dimensions Including Depth of Door: 1500H x 418W x 578D (mm)
 Door Shape Flat Framed: 10 mm
 Energy Consumption-Day Mode: 0.3 kWh/24h (16°C) / 0.7 kWh/24h (32°C)
 Energy Consumption-Night Mode: 0.2 kWh/24h (16°C) / 0.7 kWh/24h (32°C)
 Freezer Volume: 18L
 Gross Volume Fresh Food Compartment: 133 L
 Net Weight: 34kg

700-03910 THETFORD T1274E-Z300C201R23X 274L COMPRESSOR FRIDGE

700-03912 THETFORD T2175 174L COMPRESSOR FRIDGE

700-03724 THETFORD INDEPENDENT FLUE KIT - WHITE



700-03725 THETFORD INDEPENDENT FLUE KIT - BLACK



700-03722 THETFORD FLUE KIT To suit N304, N504 and N604



700-03730
THETFORD TOP OUTSIDE
VENT FOR 3-WAY FRIDGES
(WHITE)



SPECIFICATIONS

Main Dimensions: 186H x 483W (mm)
 Cut Out Dimensions: 156 x 451W (mm)
 Net Weight: 0.5kg

700-03732
THETFORD BOTTOM
OUTSIDE VENT FOR 3-WAY
FRIDGES (WHITE)



SPECIFICATIONS

Main Dimensions: 186H x 483W (mm)
 Cut Out Dimensions: 156 x 451W (mm)
 Net Weight: 0.5kg

700-03736
THETFORD TOP OUTSIDE
VENT FOR 3-WAY FRIDGES
(BLACK)



SPECIFICATIONS

Main Dimensions: 186H x 483W (mm)
 Cut Out Dimensions: 156 x 451W (mm)
 Net Weight: 0.5kg

700-03738
THETFORD BOTTOM
OUTSIDE VENT FOR 3-WAY
FRIDGES (BLACK)



SPECIFICATIONS

Main Dimensions: 186H x 483W (mm)
 Cut Out Dimensions: 156 x 451W (mm)
 Net Weight: 0.5kg

700-03837
THETFORD LARGE FRIDGE
VENT WHITE

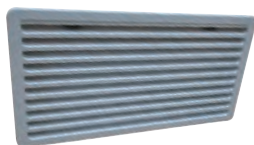

Specifications

Main Dimensions: 281H x 533W (mm)
 Cut Out Dimensions: 248 x 488W (mm)
 Net Weight: 0.7kg

700-03740
THETFORD LARGE FRIDGE
VENT BLACK



SPECIFICATIONS

Main Dimensions: 281H x 533W (mm)
 Cut Out Dimensions: 248 x 488W (mm)
 Net Weight: 0.7kg

700-03776
THETFORD SR, VENT
257 X 432 L.GREY



THETFORD COOKING APPLIANCES

Who says you can't enjoy culinary cooking in your camper, caravan or holiday home? With the well-designed hobs, ovens, grills and sinks from Thetford, you can! Thetford cooking appliances are designed to be as home like as possible. Thetford uses the highest quality materials and thoroughly test each appliance to ensure its ultimate safety - and your satisfaction. All Thetford cooking appliances are designed and manufactured in the British city of Sheffield, and they come with a three year manufacturer's warranty.

700-04004
THETFORD SPINFLO K1520 ALL IN ONE
OVEN COOKTOP(3GAS + 1 ELC) + GRILL

This all-in one combination cooker with 3 gas burner and 1 electric hotplate stove, grill and oven brings RV cooking to another level. Light, fast, big and delicious. Less weight, higher quality.

- > High-quality materials and components
- > Contemporary, home-like design
- > Optimal use of space
- > Superior cooking performance



SPECIFICATIONS

12V spark ignition: Yes
 Amount of burners: 4
 Build-in dimensions (HxWxD): 640 x 496 x 493 mm
 Electric hot plate (220-240V 50Hz): 1025 W Ø 145 mm
 Gas hot plate burners: 1x 0,95 kW 2x 1,70 kW
 Grill burner: 1,65 kW
 Grill capacity: 15 L
 Oven burner: 1,75 kW
 Oven capacity: 34 L
 Overall dimensions (hxwx d): 645 x 515 x 501 mm
 Pan rest: 1 piece
 Total 230V power: 1025 W *Hotplate
 Total heat input: 7,45 kW
 Weight: 25.5 kg

700-04011

THETFORD SPINFLO K1520 ALL IN ONE OVEN COOKTOP(4GAS)+GRILL

All-in one combination cooker with 4 gas burner stove, grill and oven brings RV cooking to another level. Light, fast, big and delicious. Less weight, higher quality.

- > High-quality materials and components
- > Contemporary, home-like design
- > Optimal use of space
- > Superior cooking performance



SPECIFICATIONS

12V spark ignition: Yes
 Amount of burners: 4
 Build-in dimensions (HxWxD): 640 x 496 x 493 mm
 Electric hot plate (220-240V 50Hz): n.a.
 Gas hot plate burners: 1x 0,95 kW / 3x 1,70 kW
 Grill burner: 1,65 kW
 Grill capacity: 15 L
 Oven burner: 1,75 kW
 Oven capacity: 34 L
 Overall dimensions (hxwx d): 645 x 515 x 501 mm
 Pan rest: 1 piece
 Total 230V power: n.a.
 Total heat input: 9.75 kW
 Weight: 24.5 kg

700-04033

THETFORD SPINFLO MINIGRILL K1540 COOKTOP(4 GAS)+GRILL

All-in one combination cooker with 4 gas burner stove and grill brings RV cooking to another level. Light, fast, big and delicious. Less weight, higher quality.

- > High-quality materials and components
- > Contemporary, home-like design
- > Optimal use of space
- > Superior cooking performance

SPECIFICATIONS

12V spark ignition: Yes
 Amount of burners: 4
 Build-in dimensions (HxWxD): 312 x 496 x 493 mm
 Door opening grill: Drop down
 Electric hot plate (220-240V 50Hz): n.a.
 Gas hot plate burners: 1x 0,95 kW 3x 1,70 kW
 Grill burner: 1,65 kW
 Grill capacity: 15 L
 Main dimensions (h x w x d): 310 x 515 x 501 mm
 Net weight: 14,5 kg
 Pan rest: 1 piece Black Enamel
 Total 230V power: n.a.
 Total heat input: 7,7 kW
 Weight: 14.5 kg

700-04022

THETFORD SPINFLO MINIGRILL K1540 COOKTOP(3GX1E)+GRILL

This combination cooker with 3 gas burners and 1 electric hotplate stove, and grill brings RV cooking to another level. Light, fast, big and delicious. Less weight, higher quality.

- > High-quality materials and components
- > Contemporary, home-like design
- > Optimal use of space
- > Superior cooking performance



Specifications

12V spark ignition: Yes
 Amount of burners: 4
 Build-in dimensions (HxWxD): 312 x 496 x 493 mm
 Door opening grill: Drop down
 Electric hot plate (220-240V 50Hz): 1025 W Ø145 mm
 Gas hot plate burners: 1x 0,95 kW 2x1,70 kW
 Grill burner: 1,65 kW
 Grill capacity: 15 L
 Main dimensions (h x w x d): 310 x 515 x 501 mm
 Pan rest: 1 piece Black Enamel
 Total 230V power: 1025 W
 Total heat input: 6,0 kW
 Weight: 15.5 kg

700-04040

TRIPLEX MK3 - DUAL FUEL

A compact combination stove, grill and oven that affords multi-function versatility in a durable, light-weight and easy to clean unit. Its main features include: flame failure device on valves, automatic shut off on glass, glass lid, oven shelf, multifunctional pan, detachable handle and pan trivet.



SPECIFICATIONS

Overall Dimensions: 468H x 456W x 500D (mm)
 Enclosure Cut-Out Dimensions: 463H x 445W x 493D (mm)
 Gas Hotplate Burners: 2 x 1.5kW
 Electric Hotplate (220-240V, ~50Hz): 1000W
 Oven Capacity: 36L
 Net Weight: 23.1kg

700-04058

TRIPLEX - GAS ONLY

A compact combination stove, grill and oven that affords multi-function versatility in a durable, light-weight and easy to clean unit. Its main features include: flame failure device on valves, automatic shut off on glass, glass lid, oven shelf, multifunctional pan, detachable handle and pan trivet.



SPECIFICATIONS

Overall Dimensions: 468H x 456W x 500D (mm)
 Enclosure Cut-Out Dimensions: 463H x 445W x 493D (mm)
 Gas Hotplate Burners: 2 x 1.5kW; 1 x 2.5kW
 Oven Capacity: 36L
 Net Weight: 25.5kg

700-04070

OVEN AND GRILL MK3 - DUPLEX

Enhance your kitchen with a Thetford combination oven and grill. They are made of high quality materials and components that are easy to use. Features include: piezo ignition, flame failure device on valves, oven shelf, multifunctional pan, detachable handle and pan trivet.



SPECIFICATIONS

Overall Dimensions: 445H x 456W x 440D (mm)
 Enclosure Cut-Out Dimensions: 438H x 445W x 490D (mm)
 Oven Capacity: 36L
 Net Weight: 13.5kg

700-04100

ARGENT HOB MK3 - 3 BURNER

The Argent Hob is a stainless steel hob with detachable pan stands, that are easy to clean and enamelled burner lids. Features include: flame failure device on valves, smoked black glass lid and automatic shut off on lid. Supplied with Piezo ignition.



SPECIFICATIONS

Overall Dimensions: 110H x 570W x 470D (mm)
 Worktop Cut-Out Dimensions: 545W x 433D (mm)
 Gas Hotplate Burners: 2 x 1.5kW; 1 x 2.5kW
 Net Weight: 8.0kg

700-04122

THETFORD SPINFLO K1520 ALL IN ONE FAN FORCE OVEN COOKTOP(3GAS + 1 ELC) + GRILL

This all-in one combination cooker with 3 gas burners and 1 electric hotplate stove, grill and fan assisted oven brings RV cooking to another level. Light, fast, big and delicious. Less weight, higher quality.

- > High-quality materials and components
- > Contemporary, home-like design
- > Optimal use of space
- > Superior cooking performance



SPECIFICATIONS

12V spark ignition: Yes
 Amount of burners: 4
 Build-in dimensions (HxWxD): 640 x 496 x 493 mm
 Electric hot plate (220-240V 50Hz): n.a.
 Gas hot plate burners: 1x 0,95 kW / 3x 1,70 kW
 Grill burner: 1,65 kW
 Oven Burner: 1,75 kW
 Oven capacity: 34 L
 Overall dimensions (hwxwd): 645 x 515 x 501 mm
 Pan rest: 1 piece
 Total 230V power: 15 W Fan
 Total heat input: 9.75 kW
 Weight: 24.5 kg

700-04210

TOPLINE HOB

A sleek, flush-mounting hob with a glass lid that covers burners for a clean look. It has an electric 12V DC ignition, a steel coated trim and frame. It also features: a flame failure device on valves, smoked black glass lid, flush bench top fitment and an automatic shut off on lid.



SPECIFICATIONS

Overall Dimensions: 105H x 546W x 482D (mm)
 Worktop Cut-Out Dimensions: 538W x 473D (mm)
 Gas Hotplate Burners: 2 x 1.5kW; 1 x 2.5kW
 Net Weight: 10.7kg

700-90028N

THETFORD BASIC LINE 340 HOB

A stainless steel hob that has an electric (12V) spark ignition. The pan stands are easy to remove enabling easy cleaning. Features include: domestic style black knobs (40mm in diameter), 2 gas burners (1.5kW each) and 1 rapid burner (2.5kW). It has a flame failure device installed, along with a glass lid to maximise space when not being used.



SPECIFICATIONS

Dimensions: 100H x 540W x 445D (mm)
Cut Out Required: 527W x 429D (mm)
Weight: 5.6kg

SPINFLO

700-90008N

SPINFLO 2 BURNER GRILL S/STEEL

The Thetford Spinflo two burner hotplate comes supplied with pan supports and a grill pan, with each burner featuring individual controls and safeguarding flame failure devices.



SPECIFICATIONS

Weight: 6.5 kg
Dimensions: 445W x 345D x 160H (mm)

700-90030N

THETFORD TRIPLEX CARBON (WITH SEAL)

This combination stove, grill and oven, provides multi-function versatility in a durable, lightweight and easy-to-clean unit. It also features a stainless steel interior and is backed by a three year manufacturer's warranty.



SPECIFICATIONS

External Dimensions: 468H x 456W x 500D (mm)
Oven Capacity: 36L
Oven Burner: 1.6Kw
Stove Burners: x2 1.8Kw, x1 2.4Kw
Weight: 21.5kg

700-90036

TRIPLEX - GAS ONLY

A compact combination stove, grill and oven that affords multi-function versatility in a durable, light-weight and easy to clean unit. Its main features include: flame failure device on valves, automatic shut off on glass, glass lid, oven shelf, multifunctional pan, detachable handle and pan trivet.



SPECIFICATIONS

Overall Dimensions: 468H x 456W x 500D (mm)
Enclosure Cut-Out Dimensions: 463H x 445W x 493D (mm)
Gas Hotplate Burners: 2 x 1.5kW; 1 x 2.5kW
Oven Capacity: 36L
Net Weight: 25.5kg

700-90038

SPINFLO DUPLEX GRILL & OVEN NEW LOOK MIRROR - DUPLEX

Enhance your kitchen with a Thetford combination oven and grill. They are made of high quality materials and components that are easy to use. Features include: piezo ignition, flame failure device on valves, oven shelf, multifunctional pan, detachable handle and pan trivet.



SPECIFICATIONS

Overall Dimensions: 445H x 456W x 440D (mm)
Enclosure Cut-Out Dimensions: 438H x 445W x 490D (mm)
Gas Hotplate Burners: 2 x 1.5kW; 1 x 2.5kW
Oven Capacity: 36Lt
Net Weight: 13.5kg

THETFORD K1500 SERIES COOKERS

These all-in-one combination units with stove, grill and oven offer you all the convenience to make the best meals.

FEATURES

- > Flame failure device on valves
- > Glass lid with automatic shut off
- > Oven light, oven shelf
- > Multifunctional pan
- > Detachable handle and pan trivet

SPECIFICATIONS

Overall dimensions (H x W x D): 645 x 515 x 501 mm
 Enclosure cut-out dimensions (H x W x D): 646 x 496 x 493 mm
 Total heat input: 9.21kW
 Gas hotplate burners: 1 x 0.89kW 3 x 1.72kW
 Electric hotplate (220 - 240V ~ 50Hz): N/A
 Grill burner: 1.65kW
 Oven burner: 1.53kW
 Ignition: 12V
 Oven capacity (H x W x D): 34L 250 x 380 x 304 mm
 Grill capacity (H x W x D): 15L 130 x 380 x 304 mm
 Net. weight: 25Kg

700-90062

THETFORD K1500 SERIES GAS COOKER MINI GRILL - GAS 4 BURNER/GRILL MIRROR FINISH

This compact grill and hob combination offers multi-function versatility in a durable, light-weight and easy-to-clean unit.

FEATURES

- > Flame failure device on valves
- > Glass lid with automatic shut off
- > Multifunctional pan
- > Detachable handle and pan trivet

SPECIFICATIONS

Overall dimensions (H x W x D): 310 x 515 x 543 mm
 Enclosure cut-out dimensions (H x W x D): 312 x 496 x 493 mm
 Total heat input: 7.70kW
 Gas hotplate burners: 1 x 0.89kW 3 x 1.72kW
 Electric hotplate (220 - 240V ~ 50Hz): N/A
 Grill burner: 1.65kW
 Ignition: 12V
 Grill capacity (H x W x D): 15L 130 x 380 x 304 mm
 Net. weight: 25Kg



700-90060

THETFORD K1500 SERIES GAS COOKER STOVE - GAS 4 BURNER/GRILL/OVEN MIRROR FINISH



700-04014

THETFORD GLASS LID T/S CAPRICE/MINIGRILL MK3

Replacement glass lid only to suit Thetford Caprice and Minigrill MK3.



700-90064

THETFORD K1500 SERIES GAS COOKER STOVE- GAS 4 BURNER/GRILL/OVEN CARBON FINISH



700-04052

THETFORD GLASS LID T/S TRIPLEX MK3

Replacement glass lid only to suit Thetford Triplex MK3.



700-04224
THETFORD TOPLINE 902
INDUCTION HOB 500 X 305
22 230V-15AMP

The Topline 902 is an induction hob developed and optimized for use in your caravan or motorhome including all safety and easy to use functionalities. Made from high quality Schott Ceran glass.

- > High-quality materials and components
- > Contemporary, home-like design
- > Optimal use of space
- > Superior cooking performance



SPECIFICATIONS

Hob material: Black ceramic glas
 Induction zones: 1 x 1.4 kW (1.8 kW Boost) / 1 x 1.8 kW (2.3 kW Boost)
 Knobs: Touch controls
 Net weight: 5.5 Kg
 Overall dimensions (hxwx): 53 x 305 x 500 mm
 Total heat input (electric): 2.3 kW
 Total power use: 230 V / 10 A
 Worktop cut-out dimensions (wx): 274 x 482 mm

700-04610
THETFORD PIEZO IGNITOR
FOR SPINFLO



700-04612
THETFORD GRILL+HOB KNOBS T/S
ALL SPINFLO UNITS

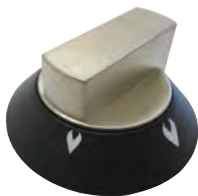

700-04614
THETFORD SPINFLO 12V IGNITION
SWITCH



700-04616
THETFORD CONTROL KNOB FOR
SPINFLO MK3 OVEN ONLY



700-04012
THETFORD OVEN RACK T/S
CAPRICE MK3



DOMETIC BURNER COOKTOPS

700-05163

**DOMETIC 2 BURNER COOKTOP
FLUSH MT S/S C/W GLASS LID &
12V IGN (480 X 370MM)**

Two burner gas stove with safety glass lid.

Dometic's new and improved two burner stove has been purpose-built for excellent cooking performance. The unit features a durable safety glass lid, protecting the burners from any damage while not in use. The dual burners provide strong, reliable heat for all your cooking needs.



FEATURES

- > Compact two-burner cooktop with improved efficiency.
- > 2 burners with a high combined heat output of 10.5MJ/h. The small left burner produces 4 MJ/h and the large right burner produces 6.5 MJ/hr.
- > Heat-resistant safety glass lid provides more workspace when closed.
- > Easy-to-clean detachable trivets
- > Stylish stainless-steel finish
- > Easy push button Piezo ignition

SPECIFICATIONS

Depth: 370 (mm)
Height: 80 (mm)
Width: 480 (mm)
Net Weight: 3.58kg
Output cooker plate 1: 1.1kW
Output cooker plate 2: 1.8kW
Burners: 2

700-05179

**DOMETIC 3 BURNER COOKTOP
FLUSH MT S/S C/W GLASS LID &
12V IGN (560 X 440MM)**

Three burner gas stove with safety glass lid Dometic's new and improved three burner stove brings cooking convenience to small spaces while continuing to deliver an excellent cooking performance. The unit features a durable safety glass lid, protecting the burners from any damage while not in use. The three burners provide strong, reliable heat for all your cooking needs.



FEATURES

- > Compact three burner cooktop with improved efficiency
- > 3 burners with a high combined heat output of 15.6 MJ/h (4MJ/h / 5.8MJ/h / 5.8MJ/h)
- > Heat-resistant safety glass lid provides more workspace when closed.
- > Easy-to-clean detachable trivets
- > Stylish stainless-steel finish
- > Easy push button 12V ignition

SPECIFICATIONS

Depth: 440 (mm)
Height: 88 (mm)
Width: 560 (mm)
Net Weight: 5.3kg
Output cooker plate 1: 1.1kW
Output cooker plate 2: 1.6kW
Output cooker plate 3: 1.6kW
Burners: 3

700-05502

NEW LIDO JUNIOR

A sturdy and compact cooker with grill and brass burners. The body is stainless steel with a painted base and a hinged lid. Burners on the new Lido Junior have now been fitted with a flame failure device, making it suitable for use inside caravans, motorhomes etc. Requires a 5/16" SAE male gas connection.



SPECIFICATIONS

Weight: 3.6kg
Dimensions: H175 x W480 x D290mm

700-05550

**HOSE 900MM T/S LIDO
JUNIOR**



700-05644

DELUXE 2.0 STAINLESS STEEL BARBEQUE WITH HIGH LID & FLAME FAILURE

The new Sizzler Deluxe 2.0 BBQ is an extremely versatile and compact cooking appliance, taking up less than half the space of most of its competitors! It is ideal to use when fitted in your "Tunnel Boot" on one of our Swivel Slides!



SPECIFICATIONS

Cooks for: 4-6 people
 LPG, propane & natural gas
 2 Burners
 Weight: 12 kg
 BTUs: 20,000 or 21 megajoules
 Dimensions: H 260mm x D 305mm x W 530mm
 Cooking surface measures: D250mm x W440mm
 R & D and AGA Approval so you can place it in a tunnel boot, or other cavities in a Caravan or RV!

700-05700

SIZZLER BARBEQUE GAS HOSE WITH BAYONET FITTING

Suitable for use in RVs with a permanent gas flow system.



700-05702

SIZZLER BARBEQUE STANDARD GAS HOSE AND REGULATOR KIT

Suitable for use when running a Sizzler Barbeque off a gas bottle.



700-05720

SIZZLER BARBEQUE COOKING RACK TO SUIT ALL SIZZLER BARBEQUES

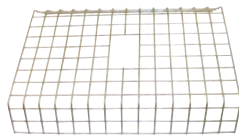

SPECIFICATIONS

Dimensions: 350W x 280L x 50H (mm)

700-05730

SIZZLER BARBEQUE UTENSIL TRAYSUITABLE FOR USE ON ALL SIZZLER BARBEQUES

The utensil tray clips onto the front of the barbeque to hold your sauces or tongs.



700-05753

SIZZLER BARBEQUE SLIDE KIT WITH QUICK RELEASE BRACKET

Suitable for use with the Sizzler Deluxe 2.0, the Slide Kit allows for installation (and storage) inside a cavity in your RV. By flicking the Quick Release Bracket, your barbeque can easily be dismantled for use in a different location.



700-05755

SIZZLER BARBEQUE SWIVEL SLIDE KIT

Similar to slide kit above, the Swivel Kit allows for installations into a narrower cavity. To use the barbeque, simply rotate 90°.



Note: BBQ not included

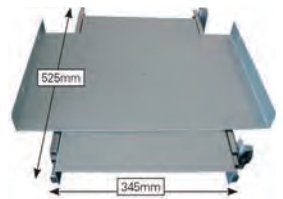

SPHERE HOT POT ELECTRIC BBQ

700-05950

SPHERE HOT POT ELECTRIC BBQ - 240VAC COMBO SKILLET

Enjoy delicious, impressive and healthy food with the two in 1 Sphere Hot Pot Electric BBQ.

The multipurpose design enables a variety of cooking methods for incredible cuisine.

Bring the best out of your ingredients with this truly versatile BBQ, it's great for meat, fish, vegetarian and vegan dishes.

The compact and sturdy design makes it a great choice to take caravanning and camping.

FEATURES

- > High-temperature non-stick surface that is durable and corrosion-resistant
- > 31x20.5cm Grill surface and 30 x 16.5cm Hot Pot
- > Separate precision temperature controls for BBQ plate and Hot Pot
- > The Hot Pot features 2 separate 1L sections for boiling.
- > Oil drain hole with removeable tray
- > Simple operation and easy to clean
- > Fast warm up for quick cooking



SPECIFICATIONS

Dimensions: 45x13x33cm
 Dimensions (Grill Surface):31x20.5cm
 Dimensions (Hot Pot): 30 X 16.5cm
 Power: 1500w
 Ac: 240v 50hz
 Material: Die Casting Aluminium
 Weight: 2.82kg
 Oil Tray
 Power Cord: 3g*0.75mm²*1.0m"

700-06052

SPHERE™ MIRRORED MICROWAVE OVEN (25L)

Add convenience to your RV with the Sphere™ microwave oven, which now features a mesmerising mirror finish.

With a large 25L oven capacity and five power level settings, it allows you to prepare a meal in no time! A digital control panel allows you to view and set your usage requirements, as well as display the ever handy clock. Defrosting frozen foods have been made easy as you're able to select whether you want to use speed or weight as the defrosting basis. It also features one-touch express cooking, a glass turntable (which is dishwasher safe), an end signal and a child safety lock. Aesthetically pleasing, the interior is a crisp white.



Note: When installing a microwave, it must be placed on a flat and stable surface able to hold the weight of the microwave. You should always cover your food whilst cooking as it prevents spattering and also helps to cook the food evenly.

SPECIFICATIONS

Output Power: 900W
 Door Open: Push button
 Net Weight: 13.9kg
 Dimensions: 281H x 490W x 396D (mm)
 Voltage: 230 - 240V
 Frequency: 50Hz

700-06154

MICROWAVE OVEN GLASS TURNTABLE

T/S Microwave Oven 25L
 900W



700-06150

MICROWAVE OVEN CONNECTOR T/S MICROWAVE OVEN 25L 900W



MY COOLMAN FRIDGES



myCOOLMAN® fridges are equipped to come where the road takes you. Keep your food fresher longer with cutting-edge cooling tech and rule your campsite with our genius quality-of-life features. Only you decide when it's time to head out, or pack up.

Powerful, robust and ready for any adventure, myCOOLMAN® fridges and freezers bring freshness to the Australian bush. Designed and engineered in Germany to suit the demanding Australian conditions, myCOOLMAN® offers versatility with a range of practical features and sophisticated technology for everyone who loves life off the beaten track. Ranging in sizes from 36 to 105 litres with single and dual zone models, cooling and freezing food of all kinds is a breeze with reliability down to minus 18 degrees.

Packaged in a sturdy transport bag, chilled goods are protected even if no power is available at short notice. Access to the contents is easy thanks to Velcro fasteners. Even when packaged, full operation of the cooler is guaranteed via visible display control and app. The bags are of course available for all box sizes. The pockets on it are very practical for cutlery, tools and the other little things that are helpful in the outback.

FEATURES

- > **Technology** - Digital display & USB port and charger with 3000mMulti-voltage system AC (240V) and DC (12/24V) with battery protection DC inlet on two ends.
- > **Multi-functional lid** - Two way opening lid (not CCP36/44) & headroom for upright standing bottles.
- > **Compressor power** - Powered by 12/24 Volt DC compressor helping you keep items cooler for longer.
- > **LED Lighting** - LED interior light to help see items in your fridge at any time of day or night.
- > **Dual Storage** - Divided storage options with removable sections & fully refrigerated multi-level compartment.

700-20000
MY COOLMAN 36L
PORTABLE FRIDGE &
FREEZER - 12/24V & 240V
 CCP 36 Single Zone *



SPECIFICATIONS

Dimensions(mm): L652 W412 H428
 Weight(kg): 18
 Volume(L): 36
 Current: 12V-3.40A / 24V-1.70A / 240V-0.44A
 Refrigerant / Quantity R134a / 43g



700-20002
MY COOLMAN 44L
PORTABLE FRIDGE &
FREEZER - 12/24V & 240V
 CCP 44 Single Zone *



SPECIFICATIONS

Dimensions(mm): L652 W412 H488
 Weight(kg): 20.5
 Volume(L): 44
 Current: 12V-3.80A / 24V-1.90A / 240V-0.30A
 Refrigerant / Quantity R134a / 45g

700-20008
MY COOLMAN 69L
PORTABLE FRIDGE &
FREEZER (DUAL ZONE) -
12/24V & 240V
 CCP 69 Single Zone *



SPECIFICATIONS

Dimensions(mm): L732 W456 H555
 Weight(kg): 27.2
 Volume(L): 69 (24/45)
 Current: 12V-5.30A / 24V-2.80A / 240V-0.31A
 Refrigerant / Quantity R134a / 75g

700-20004
MY COOLMAN 60L
PORTABLE FRIDGE &
FREEZER - 12/24V & 240V
 CCP 60 Single Zone *



SPECIFICATIONS

Dimensions(mm): L732 W456 H488
 Weight(kg): 23.5
 Volume(L): 60
 Current: 12V-5.60A / 24V-2.90A / 240V-0.30A
 Refrigerant / Quantity R134a / 65g

700-20010
MY COOLMAN 96L
PORTABLE FRIDGE &
FREEZER (DUAL ZONE) -
12/24V & 240V
 CCP 96 Single Zone *



SPECIFICATIONS

Dimensions(mm): L912 W536 H500
 Weight(kg): 31.8
 Volume(L): 96 (41/55)
 Current: 12V-5.80A / 24V-2.90A / 240V-0.34A
 Refrigerant / Quantity R134a / 96g

700-20006
MY COOLMAN 73L
PORTABLE FRIDGE &
FREEZER - 12/24V & 240V
 CCP 73 Single Zone *



SPECIFICATIONS

Dimensions(mm): L732 W456 H555
 Weight(kg): 25
 Volume(L): 73
 Current: 12V-5.90A / 24V-3.00A / 240V-0.30A
 Refrigerant / Quantity R134a / 70g

700-20012
MY COOLMAN 105L
PORTABLE FRIDGE &
FREEZER - 12/24V & 240V
 CCP 105 Single Zone *



SPECIFICATIONS

Dimensions(mm): L912 W536 H500
 Weight(kg): 28.6
 Volume(L): 105
 Current: 12V-5.50A / 24V-2.80A / 240V-0.32A
 Refrigerant / Quantity R134a / 100g

SECTION

7

PLUMBING

(Product Group - 800)

| | |
|--|-----------|
| Shurflo Pumps and Parts | 260 - 265 |
| Lockable Water Fillers | 265 - 266 |
| Waste Hose and Drinking Hose | 267 - 268 |
| Water Tanks | 269 - 271 |
| JG Plumbing Fittings | 271 - 276 |
| Plastic Plumbing Fittings | 276 - 279 |
| Fuel Safe Cans | 280 |
| Accumulator Tanks | 280 |
| Tank Cleaners | 280 - 281 |
| Thetford Sinks, Smev Sinks and Ceramic Sinks | 281 - 284 |
| Shower Hoses, Mixers and Hand Pumps | 284 - 286 |
| Faucets | 286 - 287 |

TOILETS

(Product Group - 850)

| | |
|---|-----------|
| Fiamma Bipots and Thetford Porta Pottis | 288 - 289 |
| Thetford Additives Cleaners | 290 - 292 |
| Toilet Tissue | 293 |
| Thetford Cassette Toilets | 294 - 295 |
| Thetford Toilet Accessories and Spares | 295 - 297 |
| Valterra Hoses, Valves and Fittings | 297 - 298 |
| Camco Sewer Fittings and Hoses | 298 - 300 |
| Fiamma Waste Tanks | 300 |
| Caravan Loo Treatment | 301 |
| Toilet Deodorisers | 301 - 302 |

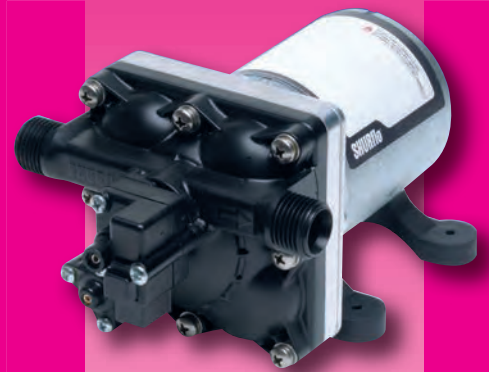

SHURFLO PUMPS



Since 1968, SHURFLO® emerged to set the standard for all freshwater pumps throughout the RV Industry. Used worldwide, SHURFLO® pumps quickly earned the reputation of being the most reliable on the market.

800-00012
SHURFLO PUMP 12V (10L, OEM BULK, NO FITTINGS)

A fresh water pump designed with a one-piece diaphragm and internal by-pass ensuring a long life and max performance. Constructed for high flow demand, this updated Shurflo pump has low noise emissions and no rapid cycling. CE and C-Tick compliant, must be installed with a filter.



SPECIFICATIONS

- Pump**
- Type: 4 Chamber Diaphragm Pump
- Ports: 1/2" - 14 NPSM-Male
- Inlet PSI: 30Psi (2.1Bar) Max
- Shut Off Pressure: 45Psi
- Electrical**
- Motor: 12V DC Permanent Magnet, Intermittent Duty
- Protection: Thermal Overload, Automatic Restart
- Fuse: 7A Recommended
- Materials**
- Housing: Polypropylene
- Hardware: Stainless and Zinc Plated Steel
- Net Weight: 2.3kg
- Dimensions: 205L x 125W x 111H (mm)

800-99997
SHURFLO 4009 OEM PUMP 12V AND FILTER KIT
 Includes x1 800-00012 and x1 800-00300

800-00022
SHURFLO 4009 PUMP (10L, RETAIL BOX)

Has all the same features and functions as 800-00012 (above) with the only difference being that it comes in a well presented retail box with fittings for display on your shelves. The Retail Box comes with x2 800-00206 fittings for your customers' convenience.



Note: A filter must be installed with the 4009 Pump in order to validate warranty.



800-99998**SHURFLO 4009 RETAIL PUMP 12V AND FILTER KIT**

Includes x1 800-00022 and x1 800-00300

800-00052**SHURFLO 4009 PUMP
24V (10L OEM BULK, NO
FITTINGS)**

Has all the same features and functions as 800-00012 with the only difference being that it runs on 24VDC. Note: A filter must be installed with the 4009 Pump in order to validate warranty.

**SPECIFICATIONS****Pump**

Type: 4 Chamber Diaphragm Pump

Ports: 1/2" - 14 NPSM-Male

Inlet PSI: 30Psi (2.0Bar) Max

Shut Off Pressure: 30Psi

Electrical

Motor: 24V DC Permanent Magnet, Intermittent Duty

Protection: Thermal Overload, Automatic Restart

Fuse: 5A Recommended

Materials

Housing: Polypropylene

Hardware: Stainless and Zinc Plated Steel

Net Weight: 2.5kg

Dimensions: 205L x 125W x 111H (mm)

800-00070**SHURFLO 30PSI 12V PUMP BULK**

Shurflo's 4009 series fresh water pump design was created with a unique one-piece diaphragm and internal by-pass, assuring long life and top performance. The 4009 series pump is constructed for high flow demand, low noise and no rapid cycling. The 4009 series fresh water automatic demand pump is super quiet, thermally protected and can run dry without damage. Note: A filter must be installed with the 4009 pump in order to validate warranty.

SPECIFICATIONS**Pump**

Type: 4 Chamber Diaphragm Pump

Ports: 1/2" - 14 NPSM-Male

Inlet PSI: 30Psi (2.1Bar) Max

Shut Off Pressure: 30Psi

Electrical

Motor: 12V DC Permanent Magnet, Intermittent Duty

Protection: Thermal Overload, Automatic Restart

Fuse: 5A Recommended

Materials

Housing: Polypropylene

Hardware: Stainless and Zinc Plated Steel

Net Weight: 2.3kg

Dimensions: 205L x 125W x 111H (mm)

800-00072**SHURFLO 30PSI 12V PUMP
RETAIL BOX**

Has all the same features and functions as 800-00070 with the only difference being that it comes in a well presented retail box with fittings. This retail box also contains all the necessary fittings for installation, however please note, a filter must be installed with the 4009 pump in order to validate warranty.

**SHURFLO 2088 REPLACEMENT PARTS****800-00150****REPLACEMENT VALVE ASSEMBLY KIT****800-00154****REPLACEMENT CHECK VALVE
KIT****800-00156****REPLACEMENT LOWER HSG/DRIVE KIT****800-00158****REPLACEMENT UPPER HSG/SWK KIT
40PSI**

SHURFLO 4009 REPLACEMENT PARTS

800-00160
REPLACEMENT UPPER ASSEMBLY #1



800-00162
REPLACEMENT VALVE ASSEMBLY #2



800-00164
REPLACEMENT DRIVE ASSEMBLY #3

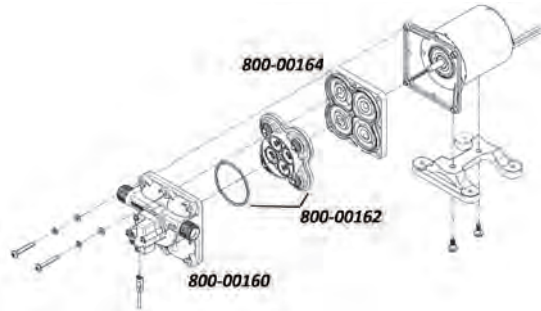

800-00170
SHURFLO PRESSURE SWITCH
To suit 4009-101-A87/B87.94-890-02



800-00172
SHURFLO UPPER ASSEMBLY #1
To suit 4009-131-A54 24V pump



SHURFLO BARBS

800-00200
ELBOW BARB WITH 1/2" TAIL (90°)



800-00202
STRAIGHT BARB WITH 1/2" TAIL



800-00204
ELBOW 1/2" THREAD INLET AND OUTLET



800-00206
STRAIGHT WINGNUT WITH 3/4" BARB



FILTERS

These clear strainers eliminate unnecessary repair by keeping dust or other particles out of your Shurflo pump. Its transparent design is also convenient as it shows when the filter should be cleaned/ emptied. The top housing is made from polypropylene and the filter itself is made from T304 stainless steel (mesh). Note that for warranty purposes, all Shurflo pumps must be installed with one of the two filters below.

800-00300
TWIST FILTER WITH 1/2"THREAD INLET AND OUTLET

This is a direct screw on filter and will require a screw-on connection.



800-00312
TWIST-ON FILTER WITH 1/2" BARB INLET

Suitable for use when a flexible hose such as a reinforced drink water hose is used.



IN LINE CHECK VALVES

800-00340
SHURFLO IN LINE CHECK VALVE WITH 1/2" BARBS



800-00350
WHALE 1/2 PLASTIC IN LINE NON RETURN VALVE

**SHURFLO WATER PRESSURE REGULATORS**

800-00502
SHURFLO IN-LINE PRESSURE WATER REGULATOR (WHITE)

A water pressure reducing valve; outlet pressure: 50psi; inlet pressure: 125psi (max)



800-00520
SHURFLO CITY WATER PRESSURE REGULATOR FLUSH MOUNT (POLAR WHITE)



800-00529
PRESSURE LIMITING VALVE 350KPA



800-00532
SHURFLO FLUSH MOUNT WATER PRESSURE REGULATOR - BLACK



800-00550
COAST 90D ELBOW HOSE ADAPTER 1/2" MPT TO CLICK ON

This quick click on hose connector has an American thread to fit properly into a Shurflo city water entry, with an elbow to prevent hose kinking.



800-00552
VALTERRA MALE HOSE MENDER
 Adapter to suit USA thread.



800-00600
SHURFLO RV AND MARINE FILTRATION KIT (RV-QBR-A)

Using only the highest quality approved materials, the Shurflo Filtration Kit ensures you have clean, great tasting water wherever you travel. It actively reduces the chlorine taste and odour from water. The kit includes a 1/4" filter head (with bracket), a disposable filter, a drinking water tap, mounting screws, mounting fittings and a 1.5m length of tube. Suitable for cold water only, it is recommended that after prolonged periods of non-use, that the system be flushed thoroughly i.e. let water run for 2-3 minutes before using it. When mounting the system, allow 1 1/2" (38mm) clearance below the housing or 279mm below the filter head (this will give you enough room to change the filter cartridges). Comes with a limited 1yr warranty from Pentair Water Australia.

**SPECIFICATIONS**

Micron: 0.5

Pressure Range: 30 - 125 PSI (2.1 - 8.62 Bar)

Flow Rate: 1.9L p/min

800-00650
SHURFLO REPLACEMENT CARTRIDGE FOR FILTER KIT (RV-QDFR-A)

Easily installed, the disposable quick change filter ensure you have pure water for longer. Shurflo recommends changing the filter every 6 - 12 months or when its capacity (1890L) has been reached, whichever comes first. (Alternative model number: 155 785-38)



SHURFLO PUMP FACTS

MAINTENANCE

Checking and cleaning the strainer, normal sanitizing and winterizing and occasional checking all plumbing hardware and fittings for tightness is all that is normally required. Lack of sanitizing is the number one reason for premature pump failure and poor performance over time. Lack of sanitizing will cause scale build-up on the diaphragm and valves, causing low flow and leak back (occasionally pump cycling with no faucets open or tank filling up when hooked up to city water).

SANITIZING

Potable water systems require periodic maintenance to keep components working properly and deliver a consistent flow of fresh water. Sanitizing is recommended: prior to storing, after a period of storage, or any time the system is opened or contaminated, as follows: NOTE: Check your Vehicle Owner's Manual for specific instructions. By-pass any filters or remove filter cartridges.

1. Determine the amount of common household bleach needed to sanitize the tank. 1 ml bleach per 1 liter tank size: 300 liter tank = 300 milliliters of bleach.
2. Mix the bleach with water in a container such as a gallon jug. If tank is filled through a pressurized fitting, pour the bleach into the hose before attaching the hose to the city water entry.
3. Pour the bleach solution into the tank and fill the tank with potable water. Rock the RV back and forth to coat top and sides of potable water tank.
4. Open all faucets (Hot & Cold) allowing the water to run until the odor of chlorine is detected. Allow four (4) hours of contact time to disinfect completely. Doubling the solution concentration allows for a contact time of one (1) hour.
5. Drain the tank. Refill the tank and flush the system once or twice until the odor has decreased. The residual chlorine odor and taste is not harmful.

WINTERIZING

Refer to the vehicle owner's manual for specific winterizing instructions.

If water is allowed to freeze in the system, serious damage to the plumbing and pump may occur. Failures of this type will void the warranty. The best guarantee against damage is to completely drain the pump and perform the following:

1. Drain the water tank. If the tank doesn't have a drain valve, open all faucets allowing the pump to operate until the tank is empty.
2. Open all the faucets (including the lowest valve or drain in the plumbing), allow the pump to purge the water from the plumbing, and then turn the pump OFF.
3. Using a pan to catch the remaining water, remove the plumbing at the pump's inlet/outlet ports. Turn the pump ON, allowing it to operate until the water is expelled. Turn OFF power to the pump once the plumbing is emptied. Do not reconnect the pump plumbing. Make a note at tank filler as a reminder: "Plumbing is disconnected".

4. All faucets must be left open to guard against any damage.
5. Potable anti-freeze may be poured down drains and toilets to protect p-traps and toilet seals. Sanitize the plumbing system before putting the plumbing system back in service.

PUMP W/ ADJUSTABLE PRESSURE SWITCH "OPERATION"

Restrictions in a plumbing system may cause the pump to rapid cycle (ON/OFF within 2 sec.) during low flow demands. Cycling should be minimized to prevent pulsating flow and to achieve maximum pump life. To determine if adjustment is necessary, turn tap on to lower than average flow of water. The pump should cycle, but its "OFF time" must be 2 seconds or longer. If the cycling is correct, leave well enough alone. If the pump is cycling rapidly increase the setting by turning the screw clockwise (1/2 TURN to . TURN MAX.) until the pump operates for 1 second with at least 2 seconds "OFF time". If cycling cannot be minimized consider removing plumbing restrictions or simply install a SHURFLO Accumulator.

PUMP W/ ADJUSTABLE BYPASS & ADJUSTABLE PRESSURE SWITCH "OPERATION"

The pump operates normally up to about 1 Bar [15 psi] by-pass pressure, where a spring-loaded by-pass valve opens, allowing flow back from the output side to the input side, providing smooth, steady flow with virtually no cycling, all the way down to a trickle. As a faucet is opened, the pressure will drop, the by-pass will close and full flow is achieved. This allows good flow, even with today's commonly used restrictive showers and pullout sprayer faucets. Performance will vary, of course, depending on the voltage to the pump: lower voltage = lower flow, higher voltage = higher flow. Always be cautious and practice electrical safety. It is always best to shut off power to the pump when leaving the RV/Caravan unattended.

ABOUT THE BY-PASS

The by-pass is a spring-loaded diaphragm that, when open allows water from the discharge side back to the inlet side. If the switch or by-pass are adjusted too much, the by-pass and switch shut-off can overlap and THE PUMP WILL NOT SHUT OFF. Screwing the switch screw in clockwise will raise the shut-off pressure. Unscrewing the switch screw counter clockwise will lower the pump shut-off pressure. Screwing the by-pass screw in will raise the pressure at which the by-pass starts and raise the full by-pass pressure. Unscrewing the by-pass screw counter clockwise will lower the pressure at which by-pass starts and lower the full by-pass pressure.

WARNING: If full by-pass is reached before the shut-off setting, the pump will not shut off .

Full by-pass pressure setting should be at least 0.48 bars [7 psi] higher than pump shut off pressure.

TROUBLESHOOTING

Vibration induced by driving can loosen plumbing, strainers and pump hardware.

Check for system components that are loose. Also, refer to the chart below for trouble-shooting tips.

PUMP WILL NOT START/ BLOWS CIRCUIT

- > Electrical connections, fuse or breaker, main switch, and ground connection.> Is the motor hot? Thermal breaker may have triggered; it will reset when cool.
- > Is voltage present at the switch? Bypass pressure sw. Does the pump operate?
- > Charging System for correct voltage (10%) and good ground.
- > For an open or grounded circuit, or motor; or improperly sized wire.
- > For seized or locked diaphragm assembly (water frozen?).

WILL NOT PRIME/SPUTTERS

(No discharge/Motor runs)

- > Is the strainer clogged with debris?
- > Is there water in the tank, or has air collected in the hot water heater?
- > Is the inlet tubing/plumbing sucking in air at plumbing connections (vacuum leak)?
- > Is inlet/outlet plumbing severely restricted or kinked? Restrictive valves?
- > Proper voltage with the pump operating (>10%).
- > For debris in pump inlet/outlet valves or swollen/dry valves.
- > Pump housing for cracks or loose drive assembly screws.

RAPID CYCLING

- > For restrictive plumbing and flow restrictions in faucets/ shower heads.
- > Water filter/purifier should be on separate feed line.
- > Shut-off pressure set too low.

PUMP WILL NOT SHUT-OFF / RUNS WHEN NOZZLE IS CLOSED

- > Output side (pressure) plumbing for leaks, and inspect for leaky valves or toilet.
- > For air trapped in outlet side (water heater) or pump head.
- > For correct voltage to pump (>10%).
- > For loose drive assembly or pump head screws.
- > Are the valves held open by debris or is the rubber swollen?
- > Pressure switch operation. By-pass set higher than shut-off.

NOISY OR ROUGH OPERATION

- > For plumbing which may have vibrated loose.
- > For a restricted inlet (clogged strainer, kinked hose, restrictive valves).
- > Is the pump plumbed with rigid pipe causing noise to transmit?
- > Does the mounting surface amplify noise (flexible)? Does it bang like a drum?
- > For mounting feet that are loose or are compressed too tight.
- > For air in the system. Check all fixtures for air and bleed system.
- > The motor with pump head removed.

Is noise from motor or pump head?

LEAKS FROM PUMP HEAD OR SWITCH

- > For loose screws at switch or pump head.
- > Switch diaphragm ruptured or pinched.
- > For punctured diaphragm if water

LOCKABLE WATER FILLERS

800-00900

LOCKABLE WATER FILLER COMPLETE WITH CAP AND KEYS "WHITE" 25MM OUTLET



800-00902

LOCKABLE WATER FILLER WITH 25MM OUTLET, COMPLETE WITH CAP - BLACK



800-00920

SPARE CAP AND KEYS ONLY "WHITE"



800-00922

SPARE CAP AND KEYS - BLACK ONLY



800-01063

WATER FILLER CAP (BLACK)

Lockable, comes with two keys.



800-01064

WATER FILLER CAP (WHITE)

Lockable, comes with two keys.



LOCKABLE WATER FILERS

800-01000
AC41 WATER FILLER WITH LID



800-01091
DOOR SET FOR WATER FILLER INLET



SQUARE LOCKABLE WATER FILLER

800-01081
DUAL LOCKABLE WATER FILLER WITH PLASTIC VALVE



SPECIFICATIONS

Dimensions Overall: 195W x 167H x 47D (mm)
Dimensions Cut Out: 147W x 118H (mm)

800-01092
INLET CONNECTOR FOR WATER FILLER



800-01096
KEYS (PAIR) ONLY (PLASTIC) FOR WATER FILLER



800-01082
SPARE KEY TO SUIT DUAL LOCKABLE WATER FILLER

Also suits external shower unit
800-06000 and 800-06002



CAMCO TASTE PURE IN-LINE WATER FILTER

800-01200
RV MARINE WATER FILTER

Safe Water Matters
Camco's TastePURE RV/Marine Water Filter with Flexible Hose Protector reduces bad taste, odor, chlorine and sediment in drinking water with a 20-micron sediment filter. Also features GAC (Granular Activated Carbon) filtration in combination with KDF to prevent undesirable bacteria growth when the filter is not in use.

Durable in-line, exterior mount filter has a wide body for increased flow. Includes bonus quick change hose fittings. Not designed or tested with fish tanks or ponds. Made in the USA.



800-01088
WATER FILLER INLET (BLACK)

SPECIFICATIONS

Dimensions: 230W x 153H x 83D (mm)



800-01090
WATER FILLER INLET (WHITE)

SPECIFICATIONS

Dimensions: 230W x 153H x 83D (mm)



Protects against:

- > Bad Tastes
- > Odours
- > Sediments
- > Bacteria
- > Chlorine
- > Made in the USA

800-01110
WATER FILLER LOCKABLE

Accepts a 32mm or 35mm hose and has a tank vent connection. Is UV and impact resistant and can be painted if required.

SPECIFICATIONS

Dimensions Overall: 165H x 152W x 76D (mm)
Dimensions Cut Out: 121H x 108W (mm)



Flush RV or Marine water system by allowing tap to run several minutes if system has not been used recently. We recommend always using a water pressure regulator.

Filter Life / Replacement

Filter life depends on water quality. Replace when an undesirable taste or odor appears or if water flow decreases significantly.

800-01210

THE THIRSTY NOMAD 5 IN 1 WATER PURIFYING FILTER

100% Australian Designed, Owned & Operated, the Thirsty Nomad has been engineered by dedicated water scientists. Their caravan water treatment system is offering you a means to treat the highly mineralised bore water and then purify your water (eliminate 99.9999% of harmful pathogens) in two steps. The highest level of protection, ideal for the carvanner, off roader, those with compromised immune systems, young families, or those drawing from rivers and streams. Tested and proven for microbiological elimination at leading Australian Laboratory Symbio Laboratories to Australian Standard AS/NZS Standard 4276.7 Water Microbiology.



800-01280

FLAT OUT 6M WASTE HOSE 25MM ID (ON COMPACT REEL)



SPECIFICATIONS

Dimensions: 300W x 360H (mm)

800-01290

FLAT OUT 9M WASTE HOSE 32MM ID (ON MULTI-REEL)

* Empty reels also available, please refer to Section 3



SPECIFICATIONS

Dimensions: 375W x 440H (mm)

800-01230

MARINE AND OUTDOOR WATER HOSE

A 10m drink water hose supplied on a manually retractable hose reel. Great for any RV, the hoses' reinforced core ensures continuous water flow. Compact in design (just 1.59cm wide), it has a carry handle for portability. (The hose comes standard with a 3/4" BSP threaded connection. Should this type of thread not be suited to your needs, an Adaptor Kit can be purchased - (refer to part number 800-01241 below)



SPECIFICATIONS

Dimensions: 1.59W x 1000L (cm)

FLAT-OUT HOSES

800-01250

FLAT OUT 15M DRINK HOSE 25MM ID (ON MULTI-REEL)



SPECIFICATIONS

Dimensions: 375W x 440H (mm)

800-01310

WHITE NON-TOXIC REINFORCED WATER HOSE (12MM X 10M)



800-01260

FLAT OUT 10M DRINK HOSE 25MM ID (ON COMPACT REEL)



SPECIFICATIONS

Dimensions: 300W x 360H (mm)

BLACK WASTE HOSE 25MM ID

Corrugated flexible hose, tough and durable waste hose with a "smooth" inner lining to prevent clogging available in 10m or 30m rolls with a 25mm ID diameter.

800-01332

10M ROLL BLACK WASTE HOSE 25MM ID



800-01270

FLAT OUT 9M WASTE HOSE 25MM ID (ON MULTI-REEL)

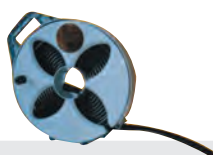

SPECIFICATIONS

Dimensions: 375W x 440H (mm)

800-01342

30M ROLL BLACK WASTE HOSE 25MM ID



BLACK WASTE HOSE 27MM ID

Corrugated flexible hose, tough and durable waste hose with a "smooth" inner lining to prevent clogging available in 10m or 30m rolls with a 27mm ID diameter.

800-01334 10M ROLL BLACK WASTE HOSE 27MM ID



800-01344 30M ROLL BLACK WASTE HOSE 27MM ID

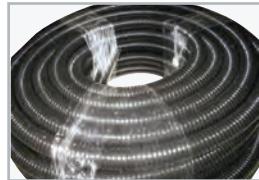

800-01336 BLACK WASTE HOSE 38MM ID

A smooth bore (inner lining) waste hose made from black PVC. It has great flexibility and is UV stabilised. Comes in a 10m roll.



SPECIFICATIONS

Nom O.D.: 45mm
Vacuum Rating: 310mm hg (@20°C)
Min. Bend Radius: 140mm

800-01346 BLACK WASTE HOSE 32MM ID

A smooth bore waste hose made from black PVC. It has great flexibility and is UV stabilised. Comes in a 10m roll.



SPECIFICATIONS

Nom O.D.: 39mm
Vacuum Rating: 310mm hg (@20°C)
Min. Bend Radius: 115mm

800-01360 20M ROLL OF NON-TOXIC REINFORCED WATER HOSE

A blue 20m plastic wrapped hose suitable for multiple applications, especially in caravans and boats. Can also be used with a standard 12mm garden hose fitting.



SPECIFICATIONS

Pressure Rating: 12.5PN

800-01362 10M ROLL OF NON-TOXIC REINFORCED WATER HOSE

A blue 10m plastic wrapped hose suitable for multiple applications, especially in caravans and boats. Can also be used with a standard 12mm garden hose fitting.



SPECIFICATIONS

Pressure Rating: 12.5PN

800-01364 100M COIL OF NON TOXIC REINFORCED WATER HOSE

A blue 100m plastic wrapped hose suitable for multiple applications, especially in caravans and boats. Can also be used with a standard 12mm garden hose fitting.



SPECIFICATIONS

Pressure Rating: 12.5PN

800-01366 12MM WHITE NON TOXIC WATER HOSE WITH FITTINGS 10M

12mm hose for the conveyance of drinking water, comes with fittings installed.

- > Proudly Australian made.
- > Conforms to AS/NZS 2070 (Plastics for food contact).
- > Excellent U.V. resistance to withstand extreme Australian conditions.
- > Manufactured from Phthalate free compound.
- > Specially manufactured as to not taint the water.



SPECIFICATIONS

Inner Core: White non tainting Polyolefin with smooth finish.
Reinforcing: High tenacity polyester yarn.
Outer Cover: U.V. stabilised clear Polyolefin with a smooth finish.
Fittings: Fitted with Perma-connect fittings c/w tap adaptor.

800-01500
ALKO TANK
52L Alko tank



SPECIFICATIONS

Dimensions: 1000mm x 330mm x 178mm

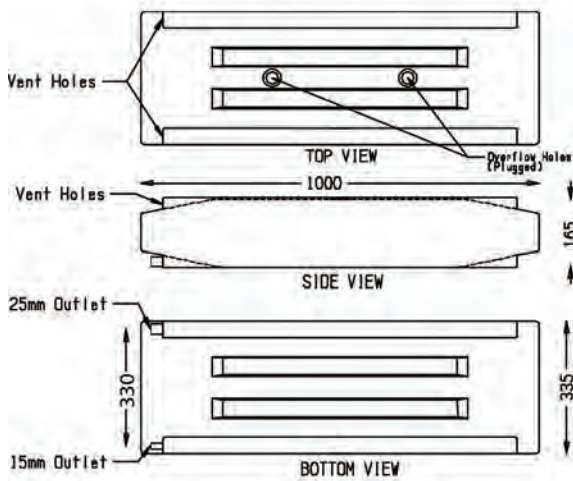

800-01530
MILLARD TANK
63L Millard tank



SPECIFICATIONS

Dimensions: 860mm x 525mm x 160mm

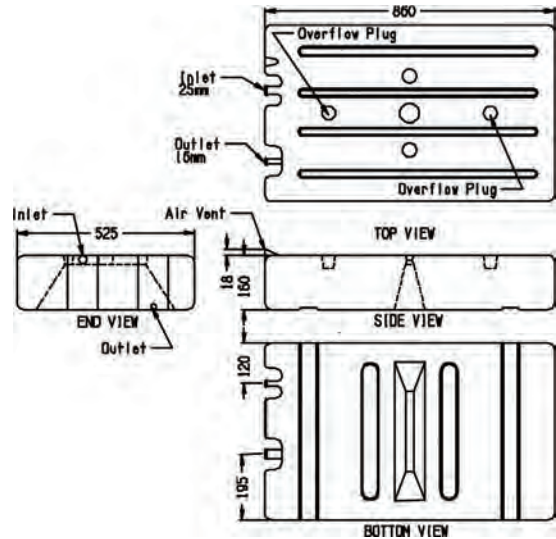

800-01520
ROUND ENDED TANK
61L round ended tank



SPECIFICATIONS

Dimensions: 900mm x 490mm x 165mm

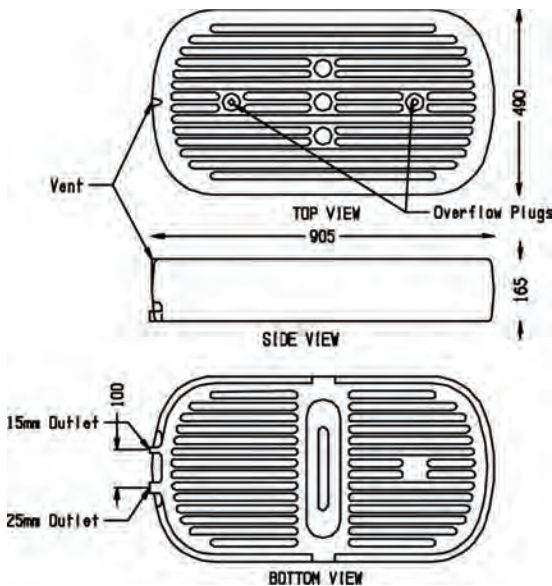

WATER TANKS

800-01540
84L STANDARD TANK



SPECIFICATIONS

Dimensions: 864mm x 508mm x 216mm

800-01567
WATER TANK BUNGS FOR 65L AND 80L TANKS



800-01569
WATER TANK BUNGS FOR 140L TANKS

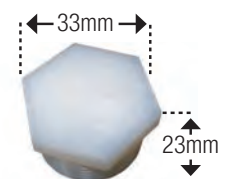

COAST TANK

800-01574
90L WATER TANK WITH TAP
 Has a 25mm barb.



SPECIFICATIONS

Dimensions: 1270L x 400W x 210H (mm)

800-01576
TOP CAP FOR JAYCO WATER TANK



800-01577
SPARE TAP FOR 800-01574



HEAVY DUTY WATER TANKS

Heavy duty water tanks, robust construction with inbuilt mounting flange complete with fittings and threaded for tap facility.

800-01580
65L TANK

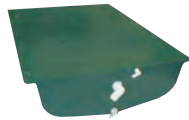

SPECIFICATIONS

Dimensions: 810 x 190 x 615mm

800-01582
83L TANK



SPECIFICATIONS

Dimensions: 810 x 265 x 615mm

800-01584
140L TANK



SPECIFICATIONS

Dimensions: 1500 x 200 x 690mm

800-01590
FIAMMA 70L WATER TANK

The Fiamma 70L fresh water tank is made of non-toxic material and weighs 3.7kg. Comes with all necessary fittings for installation.



SPECIFICATIONS

Dimensions: 240D x 710L x 470Wmm

800-01600
WATER TANK 43L MODULAR STANDARD
860 X 260 X 220MM

This new moulded modular caravan and RV water tank will change the way you use water tanks. This one tank can be configured in many ways to provide a single low cost solution.

The BR Plastics tank is blow moulded from food contact approved High Molecular Weight High Density Polyethylene. This makes the tank a super tough performer. The tank is moulded with two integral 20mm (3/4 BSP) threaded closures that can accept a wide variety of standard fixtures and fittings. Using these standard fitting the tank can be networked together to provide almost limitless water storage options for your vehicle.

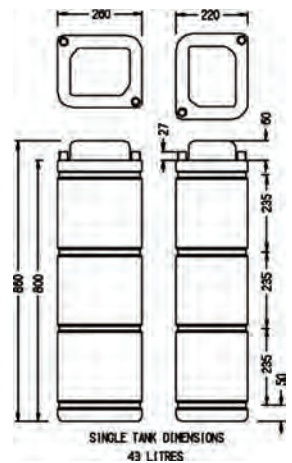

800-01602
WATER TANK 43L
MODULAR PACK ONE
860 X 260 X 220MM

Pack One consists of:

- > 1 x 43L Tank
- > 2 x Elbows
- > 1 x 12mm Director
- > 1 x 25mm Director



800-01604
WATER TANK 43L MODULAR PACK TWO
860 X 260 X 220MM

Pack One consists of:

- > 1 x 43L Tank
- > 1 x Tee
- > 1 x Cap Cap
- > 2 x 25mm directors



800-01606

**WATER TANK GREY WATER 50L MODULAR
698 X 382 X 210MM**

The BR Plastics tank is blow moulded from food contact approved High Molecular Weight High Density Polyethylene. This makes the tank a super tough performer. The tank is moulded with two integral 40mm (1.5" BSP) threaded female closures that can accept a wide variety of standard fixtures and fittings. Using these standard fittings the tank can be networked together to provide many water storage options for your vehicle.

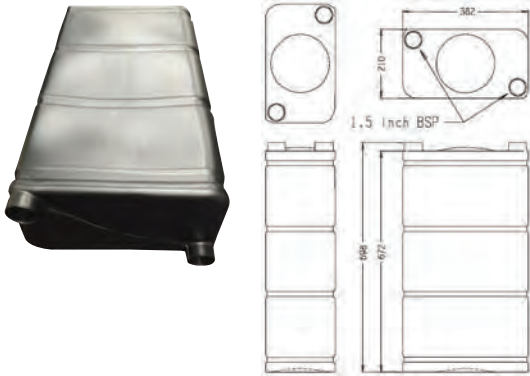

800-01241

**ADAPTOR KIT FOR MARINE AND
OUTDOOR WATER HOSE**

Allows you to attach the hose to any garden tap. Each kit contains a tap adaptor and two snap-on hose fittings.



800-01991

HOLMAN ADAPTER SET

3 piece brass adapter set.



800-01992

**NETA 1 1/6" 12MM BRASS CLICK
ON SPRAY ADAPTOR**

Screws into sprays or pumps and clicks into hose connections.



800-01608

**WATER TANK 54L CARAVAN
AND RV WATER TANK
755 X 355 X 220MM**

The tank is moulded with three integral 20mm (3/4 BSP) threaded closers that can accept a wide variety of standard fixtures and fittings.



JOHN GUEST PLUMBING FITTINGS

800-02000

**JG FEMALE PLASTIC CONNECTOR
FOR 12MM X 3/8 FBSP**



800-02001

**JG FEMALE PLASTIC CONNECTOR
FOR 12MM X 3/8" FBSP**

Has a shallow (approx. 7mm deep) thread.



800-02002

**JG FEMALE PLASTIC CONNECTOR
FOR 12MM X 1/2 FBSP**



800-02004

**JG 1/2 BARB FOR TUBE FITTING
15MM X 1/2"**



800-02006

**JG STRAIGHT 12MM X 1/2 BSPT
MALE ADAPTER**



TAP FITTINGS

800-01327

3/4" BSP SPRINKLER ADAPTOR



800-01328

3/4" - 1" TAP ADAPTOR



7 SECTION

PLUMBING FITTINGS

800-02008
JG PLASTIC 12MM TEE CONNECTOR



800-02025
JG 12MM LOCKING CLIP
Bag of 100



800-02010
JG PLASTIC 12MM ELBOW CONNECTOR



800-02026
JG 1/2" BRASS MALE ADAPTER WITH 12MM PLASTIC ELBOW



800-02012
JG PLASTIC 12MM STRAIGHT CONNECTOR



800-02028
JG 12MM PLASTIC SWIVEL ELBOW MALE 1/2" BSPT



800-02014
JG PLASTIC 12MM X 1/2 BSP STRAIGHT MALE STEM ADAPTER



800-02030
JG 12MM EQUAL DIVIDER



800-02016
JG PLASTIC 12MM X 10MM JOINER



800-02032
JG 12MM SINGLE CHECK VALVE



800-02018
JG PLASTIC STEM ELBOW 12MM CONNECTOR



800-02034
JG 12MM BULKHEAD ADAPTER



800-02019
JG BRASS STRAIGHT 12MM X 1/2" NPT



800-02036
JG 12MM SHUT-OFF VALVE PLASTIC



800-02023
JG 12MM TUBE INSERT
Bag of 100



800-02038
JG 12MM 3/8" STRAIGHT ADAPTER MALE PLASTIC



800-02040
JG 12MM SERIES 08 RED PLUG



800-02104
JG RED 12MM X 100M ROLL OF TUBING
No uv protection; sold per 100m roll.



800-02042
JG 12MM 1/2" TUBE TO HOSE BRASS

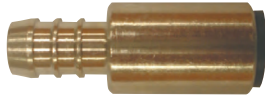

800-02120
JG BLUE 12MM X 10M ROLL OF TUBING
UV resistant, sold per 10m roll.



800-02048
JG TUBE TO HOSE CONNECTOR (12MM X 10MM)



800-02122
JG BLACK 12MM X 10M ROLL OF TUBING
UV stabilised, sold per 10m roll.



800-02098
JG TUBE CUTTER
(sold separately)



800-02124
JG RED 12MM X 10M ROLL OF TUBING
No uv protection, sold per 10m roll.



800-02100
JG BLUE 12MM X 100M ROLL OF TUBING
UV resistant, sold per 100m roll.

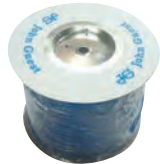

800-02150
PINK WATER SEAL TAPE 12MM X 10M ROLL

- > Resistant to almost all types of acids, bases, solvents, chemicals etc., (with the exception of fluorine, some fluoride chemicals and melted alkali metals).
- > Non-flammable (ASTM D-635 D-470). Non-ageing. High tensile strength even at low temperatures. Break-down resistant, especially, in connection with bending and vibration
- > Suitable for Natural Gas and LPG (Propane and Butane)



800-02101
JG COLLET RELEASE TOOL SET
A spacing tool used to help create space for, or remove, a locking clip.



800-02102
JG BLACK 12MM X 100M ROLL OF TUBING
UV stabilised, sold per 100m roll.



JOHN GUEST WATERMARK FITTINGS

The John Guest Speedfit RV Range has been specifically designed to meet Australian Standards and to be WaterMark compliant. The benefits of this range is its increased maximum working temperature and pressure. JG Speedfit tube fittings are warranted to achieve 80°C at 1000 kPa.

Push-fit plastic fitting for the connection of plastic and copper pipe. Designed, manufactured and assembled in the UK by John Guest Speedfit. Simply push the fitting fully onto the pipe and twist the plastic nut clockwise to lock in place. Should the need arise to demount the connection unlock the nut and push the collet towards the body of the fitting and pull the pipe to release. The fitting ensures an easier working environment in confined places and removes the need for hot works on site. Installation can be reduced by around 40% against traditional fixing methods.

800-02200
JG WATERMARK EQUAL STRAIGHT CONNECTOR
12MM PEM0412W

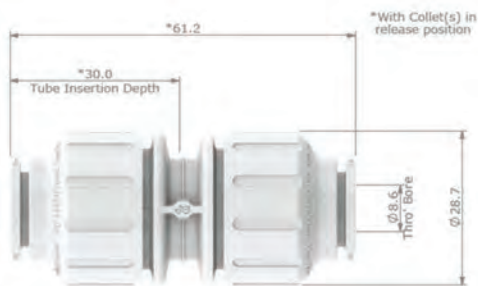

800-02202
JG WATERMARK EQUAL ELBOW
12MM PEM0312W

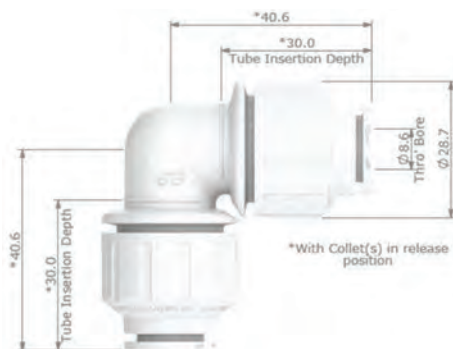

800-02204
JG WATERMARK EQUAL TEE 12MM PEM0212W

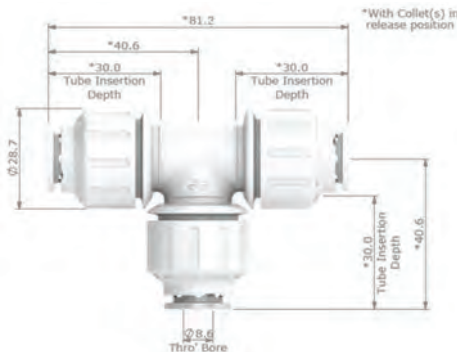

800-02206
JG WATERMARK STEM ELBOW
12MM PEM2212W

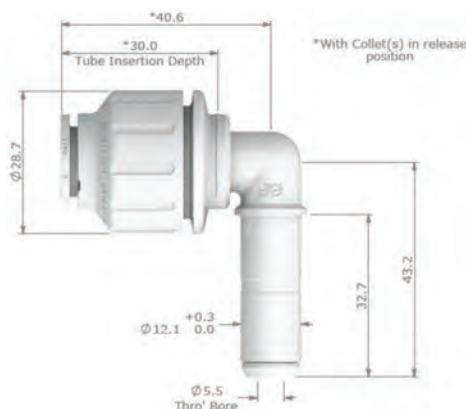

800-02208
JG WATERMARK STEM TEE 12MM PEM5312W

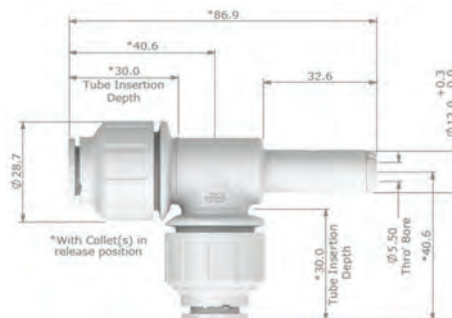

800-02210
JG WATERMARK STEM REDUCER
12MM PEM061612W

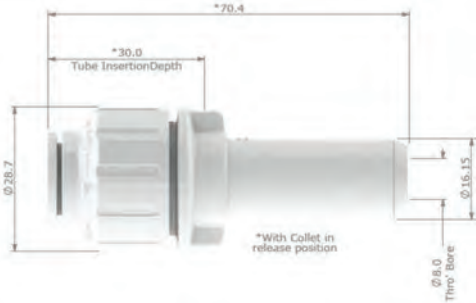

800-02216
JG WATERMARK END CAP 12MM
PSE4612W

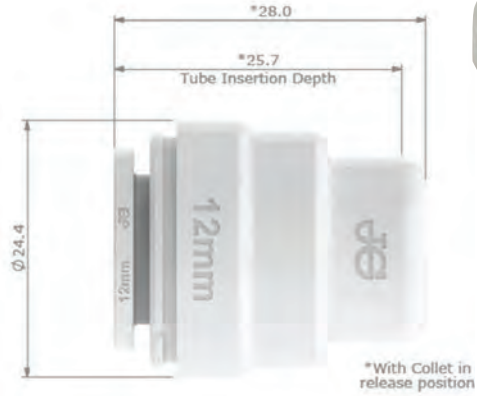

800-02212
JG WATERMARK STRAIGHT TAP
CONNECTOR 12MM PEMSTC1214 1/2
BSP

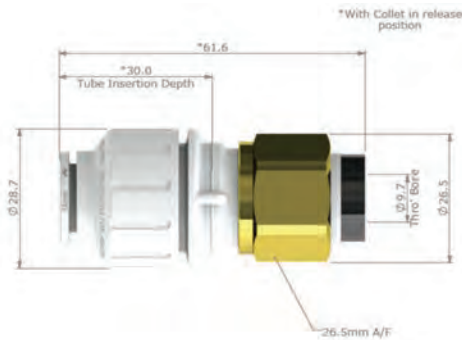

800-02218
JG WATERMARK MALE ADAPTOR
12MM NC2771 1/2 BSPT
 Ideal for use with Suburban HWS

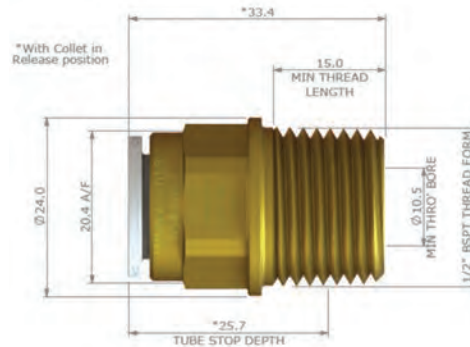

800-02214
JG WATERMARK BENT TAP
CONNECTOR 12MM PEMBTC1214 1/2
BSP

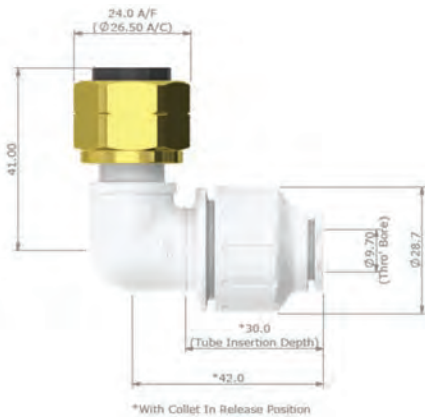

800-02220
JG WATERMARK FEMALE
ADAPTOR 12MM MW451213 3/8
BSP

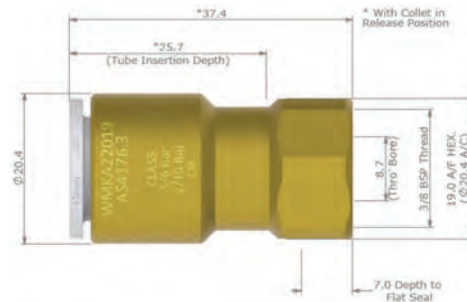

800-02223
JG WATERMARK TUBE INSERT
12MM TSM12
 Bag of 50

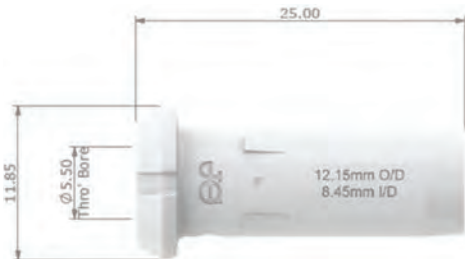

800-02224
JG WATERMARK BPEX TUBE
12MM X 50M 12BPEX-50C



800-02227
JG WATERMARK
COLLECT CLIP BLUE
12MM CM1812B
 Bag of 100



800-02229
JG WATERMARK
COLLECT CLIP RED
12MM CM1812R
 Bag of 100



PLASTIC PLUMBING FITTINGS

800-02300
PLASTIC BARBED ELBOW 13MM



800-02302
PLASTIC BARBED ELBOW 19MM



800-02304
PLASTIC BARBED
ELBOW 25MM



800-02306
PLASTIC BARBED
JOINER 13MM



800-02308
PLASTIC BARBED JOINER
19MM



800-02310
PLASTIC BARBED JOINER
25MM



800-02312
PLASTIC BARBED
TEE 13MM



800-02314
PLASTIC BARBED
TEE 19MM



800-02316
PLASTIC BARBED
TEE 25MM



800-02318
PLASTIC BARBED
END PLUG 13MM



800-02320
PLASTIC BARBED
END PLUG 19MM



800-02322
PLASTIC BARBED END
PLUG 25MM



800-02340
13MM BARBED X 1/2" BSP FEMALE
THREADED ELBOW



800-02324
PLASTIC BARBED REDUCING
JOINER 19MM X 13MM



800-02342
19MM BARBED X 1/2" BSP
FEMALE THREADED ELBOW



800-02326
PLASTIC BARBED REDUCING
JOINER 25MM X 13MM



800-02344
25MM BARBED X 1/2" BSP
FEMALE THREADED ELBOW



800-02328
PLASTIC BARBED REDUCING
JOINER 25MM X 19MM



800-02346
13MM BARBED X 1/2" BSP
FEMALE THREADED TEE



800-02330
19MM BARBED X 13MM
BRANCH TEE



800-02348
19MM BARBED X 1/2" BSP
FEMALE THREADED TEE



800-02332
25MM BARBED X 13MM
BRANCH TEE



800-02350
25MM BARBED X 1/2" BSP
FEMALE THREADED TEE



800-02334
25MM BARBED X 19MM
BRANCH TEE



800-02352
13MM BARBED X 1/2" BSP
MALE THREADED TEE



800-02336
13MM BARBED X 19MM BRANCH
TEE



800-02354
19MM BARBED X 1/2" BSP
MALE THREADED TEE



800-02338
19MM BARBED X 25MM BRANCH TEE



7 SECTION

PLUMBING FITTINGS

800-02356
19MM BARBED X 3/4" BSP
MALE THREADED TEE



800-02372
19MM BARBED X 1/2" BSP
MALE THREADED CORNER ELBOW



800-02358
25MM BARBED X 1/2" BSP
MALE THREADED TEE



800-02374
19MM BARBED X 1/2" BSP
FEMALE THREADED CORNER ELBOW



800-02360
25MM BARBED X 3/4" BSP
MALE THREADED TEE



800-02376
25MM BARBED X 1/2" BSP
MALE THREADED CORNER ELBOW



800-02362
13MM BARBED X 1/2" BSP
MALE THREADED ELBOW



800-02378
19MM BARBED X 1/2" BSP
MALE THREADED SIDE OUTLET
TEE



800-02364
19MM BARBED X 1/2" BSP
MALE THREADED ELBOW



800-02380
19MM BARBED X 1/2" BSP
FEMALE THREADED SIDE OUTLET
TEE



800-02366
19MM BARBED X 3/4" BSP
MALE THREADED ELBOW



800-02382
3/4" BSP NUT X 13MM TAIL



800-02368
25MM BARBED X 1/2" BSP
MALE THREADED ELBOW



800-02384
3/4" BSP NUT X 19MM TAIL



800-02370
25MM BARBED X 3/4" BSP
MALE THREADED ELBOW



800-02385
NUT AND TAIL HANSEN (40MM)
- 1.5" BSPT X 40MM TAIL



800-02386
1" BSP NUT X 13MM TAIL

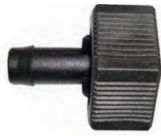

800-02388
1" BSP NUT X 19MM TAIL



800-02390
1" BSP NUT X 25MM TAIL



800-02392
PLASTIC BARBED IN-LINE VALVE
25MM



800-91000N
PIPELINE FEMALE CAMLOCK
WITH HOSE TAIL (25MM)
Made from polypropylene with a 25mm thread.



800-91002N
PIPELINE FEMALE CAMLOCK
WITH HOSE TAIL (32MM)
Made from polypropylene with a 32mm thread.



800-91004N
PIPELINE MALE CAMLOCK
(25MM)
Made from polypropylene with a 25mm BSP thread.



800-91006N
PIPELINE MALE CAMLOCK (32MM)
Made from polypropylene with a 32mm BSP thread.



800-91008N
PIPELINE DUST CAP (25MM)
Made from polypropylene with a 25mm BSP thread.



800-91010N
PIPELINE DUST CAP (32MM)
Made from polypropylene with a 32mm BSP thread.



800-91012N
PIPELINE BALL VALVE (25MM)
Made from polypropylene, this spin weld ball valve has a 25mm thread.



800-91014N
PIPELINE BALL VALVE (32MM)
Made from polypropylene, this spin weld ball valve has a 32mm thread.



800-91016N
PIPELINE GREY HOSE - 25MM
Sold per metre.



800-91018N
PIPELINE GREY HOSE - 32MM
Sold per metre.



800-91020N
PIPELINE WASTE KIT
WITH HOSE (25MM)
Kit consists of: x1 800-91012N, x1 800-91000N, x1 800-91004N, x1 800-91008N and x3 800-91016N



800-91022N
PIPELINE WASTE KIT
WITH HOSE (32MM)
Kit consists of: x1 800-91014N, x1 800-91002N, x1 800-91006N, x1 800-91010N and x3 800-91018N



FUEL SAFE ALL PLASTIC CANS

These fuel safe cans are made from high strength polyethylene for the safe transportation of fuel and other flammable liquids. Features an anti-glug pourer.

800-02400
FUEL SAFE PLASTIC 5L FUEL CAN



800-02410
FUEL SAFE PLASTIC 10L FUEL CAN



800-02420
FUEL SAFE PLASTIC 20L FUEL CAN



ACCUMULATOR TANKS

800-03000
SHURFLO ACCUMULATOR TANK



800-03010
FIAMMA A20 ACCUMULATOR TANK



800-91096N
ROLL TANK HOSE KIT (25MM)

Kit consists of: x2 800-91000N and x1 800-91016N



800-91098N
ROLL TANK HARDWARE KIT (25MM)

Kit consists of: x1 800-91024N, x1 800-91026N, x1 800-91028N, x1 800-91004N, x1 800-91008N and x1 800-91030N



800-04030
TASTE PURE (WATER FRESHENER)

Eliminate algae and slime buildup from drinking water tanks. Just 28 grams helps remove bad smells and taste from 75L of water (473ml Bottle)



800-04042
CAMCO TST GREY WATER ODOR CONTROL - 32 OZ 946 ML

Remove grease buildup in your grey water tank, sink and shower drain lines with this concentrated treatment. Only 100ml per 140L eliminates foul odors, leaving a fresh lemon scent.



800-04100

NATURAL WATER CHLORINE DIOXIDE TABLETS 8 X 4 GRAMS

Water tanks in caravans and campers need to be treated regularly to ensure there is no harmful build-up of micro-organisms and biofilm. The fact that caravans are often not used for prolonged periods of time makes it even more crucial to keep the water safe for cooking and consumption.



Organic material in water tanks can be harmful to your health and negatively affects the taste and odour of water. The build-up of biofilm in pipes can also cause problems in the flow-rate and longevity of your system. CleanOxide®, which is Chlorine Dioxide, is the most effective product on the market to clean water tanks and ensure the water is safe for consumption.

- > Effective over a broad pH range (4 to 10)
- > Controls bacteria, fungi, viruses, biofilm and algae.
- > Neutralises unpleasant taste and odours from tank water.
- > Safer than Chlorine. CleanOxide® does not react with ammonia and does not produce toxic compounds in contact with organic materials present in water.
- > Effective at lower dose rates than chlorine or bromine.
- > Non-corrosive at the recommended dose rates
- > Bio-degrades in sunlight, so no harmful effect on the environment when flushing your tank.
- > Micro-organisms do not develop resistance to CleanOxide®.
- > Approved in Australia for the treatment of drinking water since 2005.
- > Each 4 gram tablet treats 100 to 400 litres of water.

800-04120

TANK CLEANSE PRO

Tank Cleanse Pro is the ultimate water tank cleaner, destainer and sanitiser.

Ideal for Caravan, Motorhome and Boat water tanks, Tank Cleanse Pro's concentrated formula ensures that freshwater systems are free from water tainting.



Over time, stagnant water in your RV's water tank allows for the build-up of algae, mould and other harmful bacteria. Cleanse your freshwater tank for better tasting drinking and cooking water with Tank Cleanse Pro.

Tank Cleanse Pro's concentrated formula treats up to 200L of water.

SINKS

800-04900

ARGENT SINK MK3 (LEFT HAND)

This Argent sink has a left handed drain and comes with a smoked black glass lid.



SPECIFICATIONS

Overall Dimensions: 152H x 630W x 470D (mm)
 Worktop Cut-Out Dimensions: 605W x 415D (mm)
 Inside Bowl Dimensions: 100H x 290W x 368D (mm)
 Sink Capacity: 9.6L
 Net Weight: 5.5kg

800-04910

KITCHEN CENTRE MK3

A complete kitchen sink set, including plastic wash bowl, chopping board, draining board and draining rack. All accessories fit inside the stainless steel sink when not being used, which makes the Kitchen Centre a beautiful space saver. Comes with a smoked black glass lid.



SPECIFICATIONS

Overall Dimensions: 153H x 360W x 470D (mm)
 Worktop Cut-Out Dimensions: 335W x 430D (mm)
 Inside Bowl Dimensions: 99H x 290W x 368D (mm)
 Sink Capacity: 11L
 Net Weight: 3.6kg

800-04971

DOMETIC/SMEV FLUSH MOUNT BASIN C/W GLASS LID

A flush mount, stainless steel basin with a glass lid. It comes with a plug and waste kit. Now a kit.



SPECIFICATIONS

Dimensions: 420 x 440 x 145 (mm)

800-04972

DOMETIC/SMEV MIXER TAP T/S FLUSH MOUNT BASIN C/W GLASS LID

A flush mount, stainless steel basin with a glass lid. It comes with a plug and waste kit. Now a kit.



SPECIFICATIONS

Dimensions: 145H x 420W x 440D (mm)

800-04988

SMEV SINK (RECTANGULAR)

A flush mount stainless steel sink with an inox finish. Comes with a plug and waste kit.



SPECIFICATIONS

Dimensions: 280W x 380D x 145H (mm)

THETFORD SINKS

800-90004N

THETFORD SINK - LEFT HAND DRAIN

A top mount stainless steel sink with left hand drain section. It also features a smoked glass lid which allows you to maximize your work area whilst it is closed.



SPECIFICATIONS

Dimensions: 630W x 475D x 160D (mm)

800-90006N

THETFORD SINK - RIGHT HAND DRAIN

A top mount stainless steel sink with right hand drain section. It also features a smoked glass lid which allows you to maximize your work area whilst it is closed.



SPECIFICATIONS

Dimensions: 630W x 475D x 160H (mm)

800-90008N

THETFORD BASIC LINE 340 SINK

A stainless steel sink with a black glass lid and water tap hole. It is easy to clean and comes with a siphon and bung (a plug), it weighs just 2.9kg.



SPECIFICATIONS

External Dimensions: 140H x 400W x 445D (mm)

Cut Out Dimensions: 387W x 429D (mm)

Capacity: 7.5L

800-04957

KITCHEN SINK 2011

Stylish and modern stainless steel sink and drainer with rounded corners and round bowl, complete with fitting brackets.



SPECIFICATIONS

Length: 720mm

Wide: 440mm

Bowl Diameter: 365mm

Bowl Depth: 160mm

800-90500N

THETFORD BEZEL FOR SINKS (BLACK)

A rubber bezel suited to 800-90000N and 800-90002N and is sold per metre. Suitable for use as a sealant around the edges of a sink (instead of using a silicone sealant).



800-04992

SMEV SINK PLUG

A replacement plug to suit Smev sinks and has a 38mm diameter.



800-04994

SMEV PLUG AND WASTE KIT (STRAIGHT)

Plug and waste kit to suit SMEV sink (25mm straight)



800-04996

PLUG AND WASTE KIT TO SUIT SMEV SINK (25MM 90°)



800-90502N

SPINFLO 19MM WASTE STRAIGHT



800-90504N

SPINFLO 19MM WASTE ANGLED



800-90506N

SPINFLO 19MM SINK WASTE PLUG ONLY

800-04997

SMEV SINK RUBBER SEAL

Black rubber seal for SMEV sinks, sold in 3m lengths.



800-05112

RUBBER SINK PLUG

Red rubber sink plug 25mm with pull shackle.



WASTE OUTLETS

800-05150

WASTE OUTLET 25MM STRAIGHT WHITE



800-05152

WASTE OUTLET 25MM STRAIGHT GREY



800-05160

WASTE OUTLET 25MM 90° WHITE



800-05162

PLASTIC SILVER/GREY 25MM WASTE OUTLET, 90°



CERAMIC BATHROOM BASINS

Modern round designed ceramic sink basins with a smooth glazed finish. Featuring a Fireclay construction for increased strength and durability, perfect for mobile applications.

- > Heat Resistant up to 1515°C
- > Impact Resistant
- > Dirt & Stain Resistant
- > Easy Cleaning
- > Chemical Resistant
- > Hypoallergenic

800-06350
CERAMIC BATHROOM ROUND BASIN
(320X320X145MM)
- GLOSS WHITE



800-06351
CERAMIC BATHROOM OVAL BASIN
(405X330X145MM)
- GLOSS WHITE



800-06360
CERAMIC BATHROOM OVAL BASIN
(405X330X145MM)
- MATT BLACK



800-06361
CERAMIC BATHROOM OVAL BASIN
(405X330X145MM)
- MATT BLACK



800-06370
CHROME PUSH BUTTON WASTE T/S
WHITE CERAMIC BASINS



800-06371
MATT BLACK PUSH BUTTON WASTE
T/S BLACK BASINS



EXTERNAL SHOWER BOX WATERMARKED

A lockable external shower unit with hot and cold mixer taps, perfect for cleaning up before entering your RV.

- > Can be mounted either vertically or horizontally with soap holder feature moulded into the body.
- > Hand Shower Holder can be fitted inside of the door to suit mounting orientation
- > Feature quarter turn ceramic disk valves so the fittings turn in the opposite direction remaining mirrored in the open position.
- > Watermarked Approved tap and fittings
- > Supplied with soft backing gasket

SPECIFICATIONS

Dimensions: 325W x 200H x 99D (mm)

800-05900
EXTERNAL SHOWER BOX
WATERMARKED
- BLACK



800-05902
EXTERNAL SHOWER BOX
WATERMARKED - WHITE



800-06000
AUX EXTERNAL SHOWER
UNIT - BLACK

UV and impact resistant, it features an enclosed casing which prevents potential water leakage into the wall of your RV. Thanks to the large flange, it can easily be retrofitted into other external shower cutouts. It comes with a key to lock the lid when not in use and an adjustable water flow toggle lever.



SPECIFICATIONS

Water Flow: 9.5L/min max.

Cut-out Dimensions: 150H x 279W (mm)

Total Depth: 119 (mm)

800-06002

AUX EXTERNAL SHOWER UNIT - WHITE

UV and impact resistant, it features an enclosed casing which prevents potential water leakage into the wall of your RV. Thanks to the large flange, it can easily be retrofitted into other external shower cut-outs. It comes with a key to lock the lid when not in use and an adjustable water flow toggle lever.



SPECIFICATIONS

Water Flow: 9.5L/min max.
Cut-out Dimensions: 150H x 279W (mm)
Total Depth: 119(mm)

SHOWER HOSES

800-06028

HAND HELD SHOWER KIT

Includes hose, rose and bracket.



800-06030

EUTOPIA HAND HELD SHOWER KIT

Includes the hose, rose and bracket



800-06040

CHROME SHOWER HEAD KIT

Save water with this showerhead kit, thanks to a handy on/off switch that allows you to pause the water flow whilst you shampoo. This showerhead features four spray patterns from a gentle spray to hard rain. Each kit includes: a chrome showerhead, flexible shower hose (1.5m), washers, a wall mount and hardware.



HOT AND COLD SHOWER MIXERS

800-06102

EUTOPIA WHITE SHOWER MIXER 1/2" THREAD



800-06103

EUTOPIA CHROME SHOWER MIXER 1/2" THREAD



HAND PUMPS

800-06400

TROJAN HAND PUMP - WHITE

Has an efficient dual pumping action and its interior seals are made of polyurethane. Requires a 32mm hole.



800-06410

BREHA HAND PUMP (PLASTIC SHAFT) WHITE



800-06414

BREHA HAND PUMP (PLASTIC SHAFT) BLACK



800-06450

COAST CHROME HAND PUMP

Has a grey plastic shaft with chrome accents and spout.

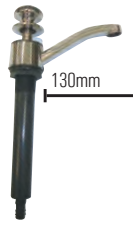

COAST WATERMARK CHROME BATHROOM FIXTURES

800-06700

CHROME FLICK MIXER WITH 160MM SPOUT



BATHROOM MODULE

800-06650

VT90 MODULE LOWER BASIN SECTION ONLY

SPECIFICATIONS
Dimensions: 820 x 670 x 160mm



800-06710

CHROME FLICK MIXER WITH 190MM SPOUT



800-06720

CHROME SHOWER FLICK MIXER



800-06655

VT90 C400 TOILET SPACER



800-06660

VT90 MODULE UPPER VANITY SECTION ONLY WITH MIRROR DOORS

SPECIFICATIONS
Dimensions: 560H x 670W x 130D (mm)



800-06730

CHROME SHOWER RAIL with Hose, Rose and Soap Dish



800-06670

ACRYLIC SOAP HOLDER - WHITE

SPECIFICATIONS
Dimensions: 328H x 220W x 90D



800-06750

HIGH RISE SINK MIXER (35MM)

Has a 4 star water rating, consuming 7.5L per minute. Comes with a 5yr manufacturer's warranty on the cartridge only.



800-06760

COAST SHOWER MIXER (35MM)

A wall mountable shower mixer, comes with a 5yr manufacturer's warranty (on the cartridge only).



800-06776

COAST WATERMARK HOT AND COLD MIXER FAUCET WITH FOLD DOWN SPOUT

Hot and cold mixer faucet chrome with folding/swivel spout.



SPECIFICATIONS

Height: 200mm (when fitted)

Height when folded: 70mm (when fitted)

Thread Size: 3/8 FBSP WaterMarked Certified

800-06770

COAST HIGH RISE SINK MIXER WITH 13CM SPOUT



800-06782

LOW PROFILE FOLD DOWN SINK MIXER TAP WATERMARKED



800-06772

COAST WATERMARK RIGHT HAND TAP, FOLD DOWN FAUCET

Right hand tap, fold down chrome faucet, conveniently folds down into the sink when not being used. Can be used for hot or cold water



Specifications

Height: 180mm (when fitted)

Height when folded: 70mm (when fitted)

Thread Size: 3/8 FBSP WaterMarked Certified

800-06900

TV15 1/2 MALE TEMPERING VALVE



SPECIFICATIONS

Cold Water Supply Temperature: 5°C - 30°C

Hot Water Supply Temperature: 60°C - 90°C

Set Temperature: 50°C standard (must be commissioned onsite by installer)

Accuracy of Outlet Temperature: +/- 3°C (as per AS4032.2)

Maximum Working Pressure (Static): 1400Kpa

Maximum Working Pressure (Dynamic): 500Kpa

Minimum Flow Rate: 3.6L/min under outlet pressure 10Kpa

800-06774

COAST WATERMARK LEFT HAND TAP, FOLD DOWN FAUCET

Left hand tap, fold down chrome faucet, conveniently folds down into the sink when not being used. Can be used for hot or cold water (red and blue buttons included).



SPECIFICATIONS

Height: 180mm (when fitted)

Height when folded: 70mm (when fitted)

Thread Size: 3/8 FBSP WaterMarked Certified

800-06904

JG 12MM NEW TEMPERING VALVE



FIAMMA BIPOTS

FIAMMA BI-POTS

These Italian Bi-Pots are a simple, and strong, self-contained fresh water flushing portable toilet. They can be dismantled (valve inclusive) to facilitate a thorough cleaning and emptying is easy and hygienic thanks to the large discharge openings. Stainless steel side hooks securely lock the top tank to the waste tank ensuring no movement whilst in use. The waste tank is made of a one-piece moulding which means no nasty leaks and the release valve is watertight too with a handy anti-odour seal. Semi-transparent lids (on the waste outlet and the top tank inlet) help to keep track of each tank's internal level so you know when to empty or top up. Both tanks are scratch resistant.

850-00500 FIAMMA BI-POT 34

SPECIFICATIONS

Top tank capacity: 15L
Waste tank capacity: 13L
Weight: 4.3kg

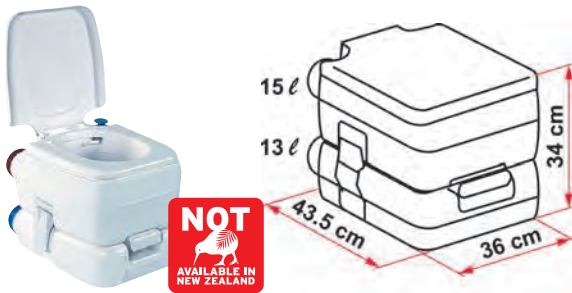

850-00502 FIAMMA BI-POT 39

SPECIFICATIONS

Top tank capacity: 15L
Waste tank capacity: 20L
Weight: 4.4kg

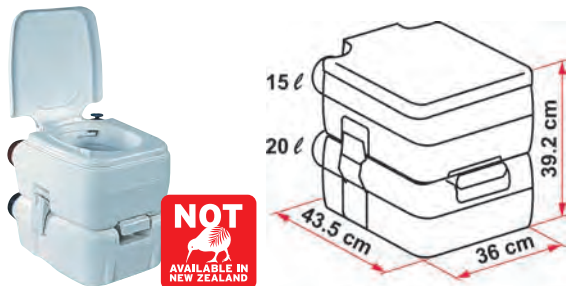

850-00510 FIAMMA BI-POT 30

SPECIFICATIONS

Top tank capacity: 10L
Waste tank capacity: 11L
Weight: 3.9kg

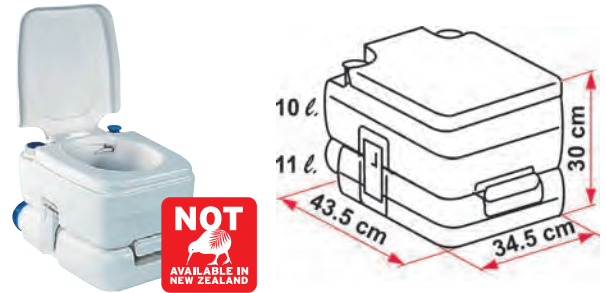

850-00592 FIAMMA SLIDE VALVE KIT FOR 1513,1520 AND BIPOT 30



850-00602 FIAMMA BI-POT TOP RUBBER SEAL FOR SLIDE VALVE



850-00612 FIAMMA BI-POT WHITE LOCKING SIDE HINGE

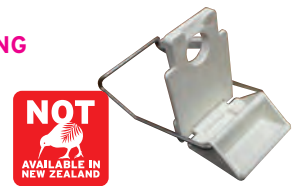

850-00618 FIAMMA BI-POT LARGE CAP FOR TOP OR BOTTOM TANK



850-00619 FIAMMA BI-POT LARGE CAP SEAL



850-00650
FIAMMA BI-POT 30
TOP TANK CAP



NOT
AVAILABLE IN
NEW ZEALAND

THETFORD PORTA POTTIS

Made from a light but tough plastic, these Porta Pottis are hermetically sealed (meaning that the seals are completely airtight, ensuring no unpleasant smells can escape!) Cleaning is also made easy thanks to detachable toilet seats. Available in five sizes, the range features lid clips (these keep the lid down when not in use). They also feature a vent button for 'no splash' emptying and a holding tank indicator to tell when it's time for emptying. Comes with a limited 3 year warranty.

850-00800
145 (WHITE)

SPECIFICATIONS

Dimensions: 330H x 383W x 427D (mm)
Seat Height: 324 (mm)
Flushing System: Bellow
Holding Tank Capacity: 12L
Flush Tank Capacity: 15L
Net Weight: 3.6kg



850-00810
165 (WHITE)

SPECIFICATIONS

Dimensions: 414H x 383W x 427D (mm)
Seat Height: 408 (mm)
Flushing System: Bellow
Holding Tank Capacity: 21L
Flush Tank Capacity: 15L
Net Weight: 3.9kg



850-00820
335 (WHITE)

(Comes standard with a hold down kit)

SPECIFICATIONS

Dimensions: 313H x 342W x 382D (mm)
Seat Height: 308 (mm)
Flushing System: Piston
Holding Tank Capacity: 10L
Flush Tank Capacity: 10L
Net Weight: 3.3kg



850-00830
345 (WHITE)

SPECIFICATIONS

Dimensions: 330H x 383W x 427D (mm)
Seat Height: 324 (mm)
Flushing System: Piston
Holding Tank Capacity: 12L
Flush Tank Capacity: 15L
Net Weight: 3.8kg



850-00840
QUBE 365 (WHITE)

SPECIFICATIONS

Dimensions: 414H x 383W x 427D (mm)
Seat Height: 408 (mm)
Flushing System: Piston
Holding Tank Capacity: 21L
Flush Tank Capacity: 15L
Net Weight: 4.0kg



850-00850
THETFORD PORTA POTTI 565P (WHITE)

The 565 is the cream of Thetford's Porta Potti crop! Featuring stylish good looks, it also has a functional 443mm seat height. It also features a built-in toilet roll holder, tank level indicators and an integrated seat cover lock.

SPECIFICATIONS

Dimensions: 458H x 388W x 450D (mm)
Seat Height: 443mm
Flushing System: Piston
Holding Tank Capacity: 21L
Flush Tank Capacity: 15L
Net Weight: 5.5Kg



850-00860
THETFORD PORTA POTTI E565E (WHITE)

The 565 is the cream of Thetford's porta potti crop! Featuring stylish good looks it also has a functional 443mm seat height. It has an electric flush system (operates on x6 1.5V AA batteries which lasts 500-700 flushes). It also features a built-in toilet roll holder, tank level indicators and an integrated seat cover lock.

SPECIFICATIONS

Dimensions: 458H x 388W x 450D (mm)
Seat Height: 443 (mm)
Flushing System: Electric (battery)
Holding Tank Capacity: 21L
Flush Tank Capacity: 15L
Net Weight: 5.5kg



THETFORD AQUA CONCENTRATED 780ML

The Thetford Concentrated family features a smaller bottle that makes a bigger impact. Less = more! 0.78L Aqua Kem® CONCENTRATED = 2L Aqua Kem. The powerful new ultra-concentrated range offers outstanding odour control, an equal number of dosages compared to a 2L bottle, less weight and easy to handle bottle.

850-01025 THETFORD AQUA KEM BLUE CONCENTRATED 780ML

Concentrated toilet fluid for the waste-holding tank. A powerful, highly effective, 2 1/2 times concentrated toilet fluid for the waste-holding tank of your Cassette and portable toilet.



850-01039 THETFORD AQUA KEM BLUE EUCALYPTUS CONCENTRATED 780ML

Concentrated toilet fluid for the waste-holding tank. A powerful, highly effective, 2 1/2 times concentrated toilet fluid with a fresh eucalyptus fragrance for the waste-holding tank of your Cassette and portable toilet.



850-01042 THETFORD AQUA RINSE PINK CONCENTRATED 780ML

A highly effective, 2 times concentrated, fresh smelling fluid for the flush water tank of your Cassette and portable toilet.



850-01029 THETFORD AQUA KEM LAVENDER CONCENTRATED 780ML

The powerful new ultra-concentrated range offers outstanding odour control, an equal number of dosages compared to a 2L bottle, less weight and an easy to handle bottle.



850-01035 THETFORD AQUA KEM GREEN CONCENTRATED 780ML

Environmentally conscious, highly effective, 2 times concentrated toilet fluid for the waste-holding tank of your Cassette and portable toilet.



THETFORD AQUA KEM BLUE

Aqua Kem Blue is a powerful and easy to use additive for waste holding tanks. It has a pine scent and can be used in Cassette Toilets as well as Porta Pottis. Its formula is derived not only to suppress unpleasant smells and reduce gas build-up, but also to break down solids and toilet tissue. To use, simply pour 150ml into a 20L waste tank. Add 2-3L of water to ensure optimum performance. Thetford recommends refreshing every 4-5 days.



850-01028 AQUA KEM BLUE (2L)

850-01062 THETFORD AQUA RINSE SPRAY

A special formula developed for toilets connected to the central water tank of the vehicle. Just spray inside the bowl before or after using the toilet to ensure a smooth flush and a fresh smelling toilet. Aqua Rinse Spray coats the toilet bowl with a special, protective layer which results in a smoother flush and limits the number of flushes required. Available in a 500ml spray bottle.



850-01064 THETFORD BATHROOM CLEANER

Cleaning agent for safe, easy and thorough cleaning of all plastic surfaces in caravan or motorhome. Wipe with a damp cloth or rinse with water. For extra shine, polish with a soft, dry cloth. On particularly dirty surfaces, allow the cleaner to work in for a few minutes before cleaning or repeat the process if necessary.



850-01066 THETFORD TOILET BOWL CLEANER

A cleaner for the inner side of the toilet bowl. The thick concentrated formula of Toilet Bowl Cleaner coats the bowl for better cleaning and targets even the hard to reach areas of the bowl, leaving a lovely fresh scent behind.



850-01073 THETFORD AQUA KEM BLUE ZIP BAG SACHETS

Water-soluble toilet sachets for the waste-holding tank.

- > Easy to use: sachets completely dissolve in water
- > Apply the right dose easily
- > Highly concentrated
- > Outstanding odor control
- > Reduces gas build-up
- > Suitable for winter camping
- > Liquefies waste for easier tank emptying
- > 15 sachets



850-01074

THETFORD AQUA KEM GREEN ZIP BAG SACHETS

Water-soluble sachets for the waste-holding tank.

- > Easy to use: sachets completely dissolve in water
- > Septic tank safe (Test ISO 11734)
- > The right dose every time
- > Superior odor control with biological action
- > Liquefies waste for easier emptying
- > Reduces gas build-up
- > 12 sachets (12 x 42.5 gr.)



THETFORD DUO TANK CLEANER CONCENTRATED

850-01079

THETFORD DUO TANK CLEANER CONCENTRATED 800ML

Concentrated periodical cleaner for the waste-holding tank and grey water tank.

Concentrated periodical cleaner that removes scale, encrusting and grease deposits from the waste-holding tank and grey water tank.

Why choose Thetford Dual Tank Cleaner?

- > Removes scale, encrusting and grease deposits
- > No scrubbing required!
- > Technical parts inside the tanks are cleaned as well
- > Prolongs the lifespan of the tanks
- > Convenient small bottle.

Product Usage

Use in the waste holding-tank

1. Add 200ml to the empty tank
2. Add 5L of luke warm water
3. Shake tank vigorously.

Use in the grey water tank:

1. Add 600ml to the empty tank via the sink or shower drain.
2. Add 50L of luke warm water.
3. Drive with your RV for at least 1h, in order to cover all surfaces of the tank.

For both tanks: Empty after at least 16 hours at a designated location.



850-01080

THETFORD GREY WATER FRESH CONCENTRATED 800ML

Concentrated toilet fluid for the grey water tank Concentrated, strong, effective fluid which prevents nasty grey water smells coming from the drains.

Why choose Thetford Grey Water Fresh Concentrated?

- > Reduces deposit formation in the grey water tank
- > Outstanding grey water odour control
- > Keeps the grey water fresh and clean for longer
- > Odour free discharging of the grey water tank
- > Convenient small bottle.

For both tanks: Empty after at least 16 hours at a designated location.



850-01090

THETFORD SEAL LUBRICANT 200ML AEROSOL SPRAY

As a market leader in sanitation, refrigeration, kitchen and cooking appliances for the RV market, Thetford is always looking to make products that work wherever your next adventure takes you. Thetford Seal Lubricant is just this kind of product as it protects and prolongs the life of other plastic and rubber parts while it thoroughly lubricates your toilet seal. It is specially developed for use on toilet seals but can be used on door seals, locks, hinges, awning rails, bicycles and is absolutely safe for plastic (unlike most generic silicone-based spray lubricants).

- > Protects, lubricates and ensures pliability
- > For periodical care and maintenance
- > Specially developed for safe lubricating of (Thetford) toilets parts
- > Absolutely safe for plastics
- > Ensures smooth operation of Thetford toilet valve blades and other items.
- > Can also be used on Doors (seals, locks, hinges), awning rails and bicycles



850-02500**TOILET TISSUE**

Fiamma soft tissue -made from pure water-soluble wadded cellulose, it won't clog up tanks or waste valves (6 rolls per pack)

**850-02510****TST RV AND MARINE TOILET TISSUE**

Fast dissolving, clog resistant toilet tissue is biodegradable and septic tank safe! Ply / 4 rolls per bag, 280 sheets per roll.

**850-02522****THETFORD AQUA SOFT 6/PK 2PLY TOILET TISSUE**

A super soft toilet paper that quickly decomposes in your waste tank thus preventing clogging and damage to your waste tank. Each pack contains 6 rolls.

- > Dissolves quickly
- > Prevents clogging
- > Easier to empty waste-holding tank
- > Prevents malfunctions or damage to the waste-holding tank
- > Super-soft toilet paper.



THETFORD CASSETTES

The built-in Cassette Toilet consists of two parts: a permanently installed toilet and a removable waste-holding tank. A clever indicator lets you know when the tank needs to be emptied, and you can access and remove the tank through a small door (Service Door 3 - 850-01600 or 850-01601) on the outside of the vehicle. Choose from various models. All Thetford Cassette Toilets come with a 3 year warranty.

C402 - C

A bench model toilet with integrated water tank and electric flush. The C402 comes with a bigger 19.3Lt waste-holding tank with wheels, to allow for easy emptying.

Specifications

Dimensions: 512H x 670W x 400D (mm)
 Seating Height: 473mm
 Net Weight: 8.1kg
 Flushing System: Electric
 Capacity of Flush-Water Tank: 15L
 Capacity of Waste-Holding Tank: 19.3L (with wheels)

850-01412

C402-C CASSETTE TOILET WITH RIGHT HAND INTERNAL WATER SUPPLY



850-01422

C402-C CASSETTE TOILET WITH LEFT HAND INTERNAL WATER SUPPLY

THETFORD C220 SERIES

Based on the proven concept of the C200, the C220 is a compact Cassette Toilet with high quality functions and a completely new design. The C220 is everything you would expect from a Thetford toilet.

- > Waste-holding tank with wheels
- > User friendly controls
- > Waste-level indicator
- > Contemporary modern design
- > Larger tank (18L)
- > Easy upgrade to C263 Ceramic
- > Higher seating position
- > Larger, deeper bowl

850-90070N

THETFORD C223CS SWIVEL TOILET 12VOLT NO DOOR



SPECIFICATIONS

Dimensions: 534 x 394x 580 mm
 Seating Height: 492 mm
 Net Weight: 7.2kg
 Flushing System: Electric
 Capacity of Waste Holding tank: 18L

850-01572

THETFORD CASSETTE TOILET SWIVEL HEAD WHITE ELECTRIC C223-CS

Specifications

Dimensions: 534 x 394x 580 mm
 Seating Height: 492 mm
 Net Weight: 7.2kg
 Flushing System: Electric
 Capacity of Waste Holding tank: 18L



850-01589

THETFORD C263 CHINA BOWL TOILET

850-90094N

THETFORD C224 SWIVEL MANUAL TOILET WITH WATER DOOR & CASSETTE DOOR

SPECIFICATIONS

Dimensions: 727 x 394 x 580mm
 Seating Height: 492 mm
 Net Weight: 8kg
 Flushing System: Manual
 Capacity of Waste Holding tank: 18L



850-90090N

THETFORD C224CW SWIVEL TOILET (NO DOOR)



850-90050N

THETFORD C260CS TOILET WITH LOW BACK (NO DOOR)

Similar to the C260 Ceramic toilet (previous) with the only difference being that the C260CS has a HD polyethylene toilet bowl making it very lightweight at 7.8kg. It too has an electric flushing system for your convenience and a waste holding tank on wheels. Its compact design allows for optimal use of space inside your RV, not to mention the 900 swivel capability.



SPECIFICATIONS

Net Weight: 7.8kg

850-90060N

THETFORD BRAVURA TOILET

Suitable for RV's that have a permanent waste-holding tank, the Bravura connects to your caravan's central waste tank. It has a single foot pedal flushing system with an extra deep bowl to ensure less splashing. The Bravura is easy to install and is lightweight.



SPECIFICATIONS

Dimensions: 454H x 421W x 531D (mm)

Net Weight: 8.3kg

THETFORD C400 CASSETTES

The built-in Cassette Toilet consists of two parts: a permanently installed toilet and a removable wasteholding tank. A clever indicator lets you know when the tank needs to be emptied, and you can access and remove the tank through a small door on the outside of the vehicle.

- > Highest level of seating comfort on the market
- > Lightweight, high-quality, durable plastic
- > Quiet yet powerful flushing system with full bowl coverage
- > Homelike bowl in size and comfort
- > 3 year warranty



850-90022N

THETFORD C400 TOILET LEFT HAND NO DOOR INCLUDED

850-99991

THETFORD C400 LEFT HAND NEW TOILET KIT WITH DOOR

850-90032N

THETFORD C400 TOILET RIGHT HAND NO DOOR INCLUDED

850-99990

THETFORD C400 RIGHT HAND TOILET KIT WITH DOOR



850-93012

THETFORD SPARE CASSETTE C223 OUTSIDE VENT



THETFORD ACCESSORIES

850-01592

CASSETTE (ONLY) TO SUIT THETFORD C250 AND C263



850-93000

THETFORD L/H HOLDING TANK T/S C2 CASSETTE ELECTRIC TOILET



850-93002

THETFORD R/H HOLDING TANK T/S C2 CASSETTE ELECTRIC TOILET



850-93004

THETFORD HOLDING TANK T/S C200 SWIVEL



850-93008

THETFORD C220 SPARE CASSETTE ONLY



850-01624

LEFT-HAND HOLDING TANK TO SUIT C400 TOILET

Convenient wheels and remarkable mechanisms for easy cleaning and maintenance (19.3L capacity)



7 SECTION

THETFORD TOILET SPARES

850-01626
RIGHT-HAND HOLDING TANK
TO SUIT C400 TOILET



850-01610
WHITE SEAT AND LID ASSEMBLY (TO
SUIT C2 CASSETTE TOILET)



850-01594
THETFORD CERAMIC SEAT AND LID
TO SUIT C250



850-01614
WHITE SEAT AND LID ASSEMBLY FOR
C400



850-01600
SERVICE DOOR TO SUIT THETFORD
CASSETTE (WHITE)



850-01719
THETFORD HOLDING TANK
MECHANISM FOR C250



850-01601
SERVICE DOOR (#3) TO SUIT
THETFORD CASSETTE (BLACK)
With a pushbutton latch and lock.

850-01638
RIGHT-HAND SLIDE ASSEMBLY
FOR C400 HOLDING TANK

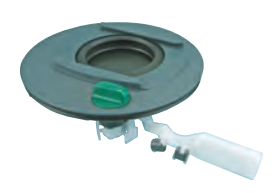

850-01604
DRAIN CAP FOR C2



850-01640
LEFT-HAND SLIDE ASSEMBLY
FOR C400 HOLDING TANK



850-01606
SLIDING COVER FOR C2, C200 AND C400
HOLDING TANKS



850-01644
THETFORD SC234 VENT
BUTTON YELLOW FOR C200



850-01608
THETFORD C200 BLADE
OPENER (YELLOW)



850-01650
MEASURING CUP ONLY
FOR CASSETTE HOLDING TANK



850-01652
LIP SEAL OLD TYPE
(PRE JUNE 2000)

850-01654
LIP SEAL NEW TYPE
(AFTER JULY 2000)



850-01656
PUMP TO SUIT C2/C402
CASSETTE TOILET



850-01660
THETFORD YELLOW DUMP CAP



850-01668
THETFORD CONTROL PANEL/
LEVEL INDICATOR FOR
C400. 3232062



850-01751
THETFORD ZADI KEY ONLY

Please note that the barrel is sold separately. Once the keys have been purchased, please contact your local Coast team to order the corresponding barrel.



850-01019
THETFORD HOLD DOWN KIT PORTA POTTI
EXCELLENCE & 565P

850-01708
THETFORD HOLD DOWN KIT BASE FOR PORTA POTTIE

THETFORD FRESH-UP SETS

The toilet Fresh-Up Set is a simple and economic way to make a used Cassette Toilet as good as new. The set includes a waste-holding tank with a toilet seat and cover, along with the free toilet fluids to freshen up the toilet. You only pay for the waste-holding tank! The toilet Fresh-Up Set is available for Cassette Toilets C2/C3/C4*, C200, C400* and C250. Need an additional waste-holding tank for longer trips? Even then the toilet Fresh-Up Set is a perfect solution. * for left and right models.



850-92134
C200 FRESH-UP SET

850-92130
C2/C3/C4 FRESH-UP SET FOR LH MODELS

850-92132
C2/C3/C4 FRESH-UP SET FOR RH MODELS

850-92138
C250/C260 FRESH-UP SET

VALTERRA SEWER HOSES

850-01808
VALTERRA 3" X 10' QUICK DRAIN
SEWER HOSE BLUE BOXED



850-01826
VALTERRA 3" X 20' QUICK
DRAIN SEWER HOSE BLUE
BOXED



VALTERRA SEWER VALVES

850-01904
VALTERRA T18 TWIN SEWER
VALVE 3" AND 1-1/2"



850-01906
VALTERRA T80 DOUBLE ROTATING
VALVE ASSY 3" AND 1-1/2"



VALTERRA SEWER FITTINGS AND HOSE CONNECTORS

850-01950
SLIP HUB 3



850-01952
SPIGOT FLANGE 3



850-01954
VALTERRA F02-2028 3" BAYONET FITTING LUGS X 3" HOSE



850-01956
VALTERRA T1024 3" STRAIGHT ADAPTER (HOOKS X 3" HOSE)



850-01958
VALTERRA T1020 3" ENDCAP WITH BAYONET HOOKS



850-01960
BAYONET END W/FLANGE 3



850-01964
VALTERRA E-Z THREADED STRAIGHT HOSE ADAPTER (F02-3101)

Adapts hose to valve and is self threading, no hose clamps required, works with right-hand or left-hand coiled hose.



850-01966
VALTERRA REP SEAL FOR E-Z (F02-3104VP)



850-01970
VALTERRA F02-3108 E-Z COUPLER BAYONET FITTING



850-01984
VALTERRA CP 1003VP 3" SEWER SLIDE VALVE



CAMCO SEWER FITTINGS

850-02100
SLIP ON RV STRAIGHT SEWER HOSE ADAPTOR



850-02110
SLIP ON RV INTERNAL SEWER HOSE COUPLER



850-02120
RV TWIST CONNECT KIT
Connect two hoses quickly for added length, suitable for 3" (76.2mm) sewer hoses.



850-02130
RV 45° SEWER HOSE ADAPTOR



850-02140
RV STRAIGHT SEWER HOSE
ADAPTOR



850-02150
RV SEWER HOSE CAP



CAMCO STANDARD SEWER HOSES

Created for the occasional RVer.

850-02300
STANDARD 10FT (3M) RV SEWER
HOSE

- > 12mils of black HTS vinyl
- > compresses to 15.5" (39cm)
- > 7.6cm diameter
- > Comes boxed



850-02310
STANDARD 20FT (6M) RV SEWER
HOSE

- > 12mils of black HTS vinyl
- > 7.6cm diameter
- > Comes boxed



CAMCO HEAVY DUTY SEWER HOSES

Created for the seasoned RVer who makes weekend trips during the season.

850-02350
HEAVY DUTY 10FT (3M) RV
SEWER HOSE

- > Made of brown HTS vinyl
- > 7.6cm diameter
- > Comes boxed



850-02360
STANDARD 20FT (6M) RV
SEWER HOSE

- > Made of brown HTS vinyl
- > 7.6cm diameter
- > Comes boxed



850-02362
CAMCO RHINOFLEX 90°
TOTE TANK
HOSE KIT

Connects your portable waste tank to any lug sewer fitting

- > Assembled kit is 3 feet long extended; 19 inches compressed
- > Includes 90 degree translucent elbow with bayonet swivel fitting
- > Fittings provide a secure, odor tight connection
- > Includes 1 storage cap



850-02364
CAMCO RHINOFLEX 90° TOTE
TANK FITTING

Designed for use with RV Tote Tanks

- > Low profile 90° elbow for maximum drainage
- > Two swivel bayonet ends
- > Odor tight connection
- > UV stabilized resin



850-02366
CAMCO RHINOFLEX SWIVEL
WRENCH SET

Provides leverage for loosening and tightening swivel fittings

- > Compatible with Rhino Revolution
- > Easy Slip and many other bayonet and lug fittings
- > Lightweight and durable
- > Ergonomic design
- > Set of 2



850-02368
REVOLUTION RV SWIVEL
HOSE KIT
3" X 20"

Kit is the complete hose kit that comes with everything you need for a quick, reliable hook-up. Features new pre-attached fittings that rotate 360 degrees.

Includes two 10 lb heavy duty vinyl sewer hoses with pre-attached swivel lug and swivel bayonet fittings and 4 storage caps. Other features include translucent elbow and wire guards to protect your hands. Patent pending. Also available: 10' Extension with pre-attached swivel lug and swivel bayonet fittings.



850-02370
EASY SLIP RV SEWER KIT
3" X 10'

This complete sewer kit comes assembled with everything you'll need for a quick, reliable sewer hook up. Nonrestrictive for free flow and faster dumping. Includes 10' HTS sewer hose, Easy Slip bayonet straight hose adapter and Easy Slip sewer elbow with 4-in-1 adapter.



850-02374
CAMCO EASY SLIP 4-1 SEWER ADAPTOR

Easy Slip 4-in-1 Sewer Adaptor with Elbow Connects hose to dump station. The elbow's tapered end accepts all 3" hoses and slip-over fittings. Adapter fits into 3" slip or 3", 3-1/2" and 4" threaded pipe. Larger inside diameter allows for faster dumping. Elbow separates from adaptor for storage in bumper.



800-01592
FIAMMA ROLL-TANK 40 F
- 40L WATER TANK (BLUE)



850-02600
FIAMMA 40LT PORTABLE WASTE TANK

A 40L waste tank with level indicator and air release valve. Comes with a 45° angle adaptor to assist with emptying.

Specifications
 Weight: 3.9kg

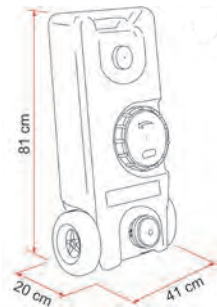

850-02820
CAMCO RHINO HOLDING TANK CLEANER - 6 PER BAG

A powerful enzyme that helps clean your holding tank and remove waste from tank walls in less than 24 hours. Simply flush one drop-in per 150 liters of holding tank capacity down your RV toilet and fill 3/4 of the way with water, then let the drop-in do the rest of the work. Regular cleaning of your holding tank helps sensors function efficiently and keep unwanted smells at bay. The easy to use drop-in is pre-measured and safe for septic tanks. For best results, use one drop-in every three months.



850-02694
FIAMMA ADAPTER FLAN
 For Valve for Roll Tanks.



850-02695
FIAMMA OUTLET
 For Roll-Tank 40W



850-02697
FIAMMA FLOAT
 For 40L Waste Roll Tank



850-02698
FIAMMA TERMINATION CAP AND SMALL TUBE TANK
 To Suit 40L Waste Tank.

850-02699
FIAMMA 3" TERMINATION CAP
 For 40L Portable Waste Tank



CAMCO CARAVAN LOO LIQUID

Camco Caravan Loo Treatment helps control unwanted odors in your waste water holding tank. The easy to use liquid contain a special and ultra-concentrated formula that helps digest waste, and a blend of fantastic-scented surfactant oils that trap unwanted odors in your tank, making your camping experience more enjoyable. The liquids are RV and marine approved and safe for all waste holding tanks—they're even great for portable camping toilets!

- > Ultra-concentrated formula, just 20ml treats up to 10L
- > Eliminates odors and lubricates sensors in the RV holding tank
- > RV and marine approved
- > Safe for all waste holding tanks
- > New Lavender scent
- > 1.89L bottle
- > Friendly to the environment
- > Easy to use
- > Formulated for Australian conditions

850-02840
FRESH SCENT LIQUID
1.89L



850-02842
LAVENDER SCENT LIQUID
1.89L



850-02844
PURE RAIN SCENT LIQUID
1.89L



ODOUR B GONE DEODORISERS

Odour-B-Gone is a tablet form of compressed per-oxy salts; it contains no fillers i.e. it is made of 100% active ingredients. The tablets slowly dissolve in the holding/waste tank of the portable toilet over a 7 day period, releasing hydrogen peroxide which is known for effective bleaching, deodorising and sanitising.

850-04052
ODOUR B GONE RV TOILET
DISK - 40PK



850-04058
ODOUR B GONE SLOW RELEASE
MINI OXYGEN DISINFECTANT
TABLETS. GREEN 2G - 10 PK

CASSETTE TOILETS : Simply drop 1 x 8 gram Blue tablet into the bottom cassette with half cup water, lasting up to 4 Days usage. The tablet will break down the matter including the paper very quickly. There are 2 size pouches, 50 x 8gram tablets (blue) & 25 x 8gram tablets both include 10 x 2gram. Mini oxygen tabs for use in a spray bottle.



The 2 gram Mini Tab (green) is used in a spray bottle, simply drop into a 400 mil bottle with cup hot water & top up with cold water, give it a shake and is ready for use. You do not have to wait till the mini tab fully dissolves. We use the spray bottle for the bowl & seat, which only takes seconds & in the heat perhaps spray the bowl 3 times a day. By spraying it is killing the bad bacteria & any odour, it is good to open the slide when spraying to allow entry into the bottom cassette. (You do not have to wait for the Mini Tab to fully dissolve, just use it!)

Use any toilet paper & if it is not breaking down use more flushing water.

ODOUR B GONE PLUS - RV TOILET TABLETS

CASSETTE TOILETS : Simply drop 1 x 8 gram Blue tablet into the bottom cassette with half cup water, lasting up to 4 Days usage. The tablet will break down the matter including the paper very quickly.. Mini oxygen tabs for use in a spray bottle.



The 2 gram Mini Tab (green) is used in a spray bottle, simply drop into a 400 mil bottle with cup hot water & top up with cold water, give it a shake and is ready for use. You do not have to wait till the mini tab fully dissolves. We use the spray bottle for the bowl & seat, which only takes seconds & in the heat perhaps spray the bowl 3 times a day. By spraying it is killing the bad bacteria & any odour, it is good to open the slide when spraying to allow entry into the bottom cassette. (You do not have to wait for the Mini Tab to fully dissolve, just use it!)

Use any toilet paper & if it is not breaking down use more flushing water.

850-04062
ODOUR B GONE PLUS - RV TOILET TABLETS BLUE 8G
- 50 PACK (PLUS 10X2G MINI OXYGEN TABS)

850-04064
ODOUR B GONE PLUS - RV TOILET TABLETS. BLUE 8G
- 25 PACK (PLUS 10X2G MINI OXYGEN TABS)

850-04066
ODOUR B GONE PLUS - RV
TOILET TABLETS. BLUE 8G - 10
PACK

CASSETTE TOILETS : Simply drop 1 x 8 gram Blue tablet into the bottom cassette with half cup water, lasting up to 4 Days usage. The tablet will break down the matter including the paper very quickly.



Use any toilet paper & if it is not breaking down use more flushing water.

850-04102
HAPPY BOWL TOILET BOWL LINERS
- 50 PER PK

No fuss, no brush! Happy Bowl liners are designed specifically for caravan and motorhome toilets and porta potties.



These bio-degradable toilet bowl liners are hygienic, eliminate toilet brushes, minimize water usage and keep your bowl sparkling clean and streak free.

Safe for septic tanks! (50 per box)

SECTION 8

TV EQUIPMENT

(Product Group - 900)

| | |
|-----------------------------------|-----------|
| Winegard Antenna and Spares | 306 - 309 |
| Antennatek Spare Parts | 310 - 311 |
| Foldaway Antenna and Accessories | 311 |
| Happy Wanderer Antenna and Spares | 312 |
| Signal Boosters | 312 |
| Furion Visions | 313 |
| Reversing Cameras | 313 - 316 |
| Sphere™ Entertainment | 317 - 319 |
| Sphere™ Cables and TV Fittings | 320 - 321 |
| Sphere™ Satellite | 323 - 324 |
| Sphere Wifi Routers | 325 |
| Fusion Entertainment | 326 |
| Furion Audio/Visual Entertainment | 327 - 329 |
| Rokk Tablet Mount | 330 |

WATER HEATERS

(Product Group - 950)

| | |
|---------------------------------------|-----------|
| Suburban HWS Range | 331 - 334 |
| HWS Maintenance Accessories | 335 - 337 |
| Suburban Nautilus HWS and Accessories | 338 - 341 |



WINEGARD SENSAR HV ANTENNA



Catch all of your favourite TV shows on your next RV adventure with the Winegard Sensar HV Antenna. This revolutionary bi-directional antenna receives both horizontal and vertical signals, allowing you to pick up a wider range of free-to-air channels on your RV's TV. Made in the USA, this robust antenna receives analogue, SD and HD signals. Never miss out on the footy grand final again - enquire about a Winegard Sensar HV today!

900-00050**(BULK PACK) WINEGARD SENSAR HV ANTENNA**

A new and innovative antenna that receives both horizontal and vertical digital signals allowing for reception in more areas. It features two independently amplified antennas to deliver maximum digital VHF/ UHF programming. Made in the USA, this bidirectional antenna receives analogue as well as standard and HD digital signals and has been designed to fit roofs from 2.5cm - 12cm thick. The OEM pack contains x4 Sensar HV Antenna kits which include: antennas mounted on the reliable crank-up lift turret assembly, a white on/ off power supply switch, hardware, 6.1mt coax cable and a 139.7cm coax cable. RCM certified. The Winegard Sensar HV comes with a 1 year limited warranty, covered by Coast.

**900-00060****(SINGLE BOX) WINEGARD SENSAR HV ANTENNA**

Has all the same features as the OEM pack (i.e. comes with complete antenna/ lift assembly, white on/ off wall plate and power supply switch, coax cables and mounting hardware) except that it is sold singularly.

**SPECIFICATIONS 4G FILTER**

Range: 144km

Operating Voltage: 12V DC

Operating Dimensions: 43.2W x 116H (cm)

Stowed Dimensions: 125.3L x 11.2H (cm)

Weight: 3.13kg

900-00070
WINEGARD SENSAR HV ANTENNA RETROFIT KIT (WITH HEAD AND MAST)

This allows you to replace the amplified head on an existing Winegard antenna with the Sensar HV bidirectional head.* It can also be used to replace the heads on Antennatek antennas as the old elevating gear can be used.

* Please check the roof clearance prior to purchasing the Sensar HV Retrofit Kit (refer to diagram, showing minimum roof top space required)

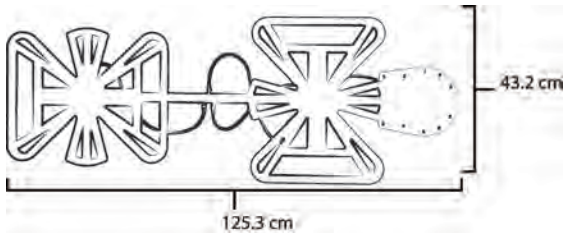

900-00360
WINEGARD WHITE 12V POWER SUPPLY (FOR TV ANTENNA)

A replacement part for a standard Winegard kit (i.e. a Winegard without a Sensar Pro).



900-00364
WINEGARD WHITE 2ND TV WALL PLATE ONLY

A convenient TV outlet with 75ohm coax cable input and output. It has a (+) 12V DC receptacle and easily surface mounts onto a wall.



WINEGARD RVH 3095 SENSAR RV TV ANTENNA W/POWER SUPPLY

900-00010
RV-3095 ANTENNA

The Sensar RV-3095 antenna has a built in amplifier and unique circuitry that gives you clear VHF/ UHF reception wherever you park your RV. Easy to install, and is bidirectional and corrosion resistant. Digital ready when combined with digital off-air tuner or HD digital television.



900-00014
(BULK PACK) WINEGARD ANTENNA

Winegard antenna same features as RV3095 supplied in bulk pack (Sold in packs of 4). Digital ready when combined with digital off-air tuner or HD digital television. Full range of spare parts available from any Coast branch.



900-00372
WINEGARD SENSAR PRO

Designed, built and hand tested in the USA, the Sensar Pro allows you to find the highest signal strength and thus watch TV. It has an adjustable amplifier which provides up to 10dB for increased performance if needed.



SPECIFICATIONS

Dimensions (cm): 11.4H x 7W x 1.9D

Weight (g): 81.6

Cables/Outputs included: Antenna IN, Cable IN, TV1 OUT and TV2 OUT

900-00400
WINEGARD DIRECTIONAL HANDLE EXTENSION

Used to extend the directional handle on leisure vehicles with a thicker roof. Roof thickness in excess of 4.75" (120.65mm) and up to 7" (177.8mm) would require an extension. (The handle and extension should be glued together after checking that you have the correct handle. The handle will not work properly if it is not glued together.)



900-00410
WINEGARD WINGMAN

This lightweight attachment (suitable for Winegard antennae only) attaches to the Sensar head and increases the digital UHF reception by up to 100%. Available in white, it acts as a digital booster. There are no wires to connect and no tools required for installation. The Wingman allows you to improve your Winegard Sensar's performance, enabling you to enjoy more free-to-air HD channels as it is optimised for digital and HD programming. The elements are powder coated to protect against the elements and rust. Note: The Wingman helps with UHF channels only and must be installed facing forward.



SPECIFICATIONS

Dimensions: 419.1W x 355.6D x 35.6H (mm)

Weight: 0.45kg

900-00422 RD 55" COAX ASSEMBLY FOR THE H/V ANTENNA



WINEGARD SPARES

- 900-00110**
RV-2005
Amplified Antenna Head
1 Kg/m
- 900-00202 (27" Tube)**
RP-2002
2 Elevator Tubes
2 Grommets
4 Pins
4 Retaining Rings
Rubber Bumper
Self Drilling
- 900-00150**
RP-0154
Boot
- 900-00190**
RP-3000
Elevating Gear
- 900-00220**
RP-4000
Worm Gear
& 12.20" Max
Elevating Shaft
Assembly w/
Wave Washer
Flat Washer
O-Ring
Worm Gear Nut
- 900-00230**
PACKAGE MODEL NO.
RP-2049
Gear Housing
2 Pins
Bearing
Nut
Bearing
O-Ring Seal
Retaining Ring
- 900-00260**
RP-3523
Base Plate
10 Screws
Rubber Boot
- 900-00300**
RP-6300
Directional Handle
Ceiling Plate
4 Screws
Spring
Decal
- 900-00320**
RP-6822
Spring
- 900-00340**
RP-2650
Nylon Bearing
- 900-00350**
RP-6795
WHITE Crank
Set Screw
- 900-00380**
RW-2000
Roof Wedge
- 900-00400**
EK-1038
Directional Handle
Extension

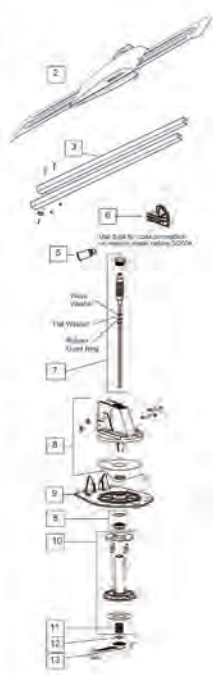

* Remove/tighten with 15/16" 12 socket
** Use 3/32 Allen Wrench for set screw

SENSOR HV SPARE PARTS

| Sensor HV Spare Parts | | | |
|---|----------|---|----------|
| 900-00150 RP-0154: Boot | | 900-00340 RP-2650: Nylon Bearing (for Crank) | |
| Part Description | Quantity | Part Description | Quantity |
| Boot (light grey) | 1 | Nylon Bearing | 1 |
| 900-00230 RP-2049: Gear Housing Assembly | | 900-00190 RP-3000: Elevating Gear | |
| Part Description | Quantity | Part Description | Quantity |
| Gear Housing | 1 | Elevating Gear | 1 |
| Pin | 2 | | |
| Nylon Nut | 1 | | |
| Nylon Bearing (for gear housing) | 1 | | |
| E-Clip | 2 | | |
| O-Ring | 1 | | |
| Nylon Bearing (for base plate) | 1 | | |
| 900-00220 RP-4000: Worm Gear Assembly | | 900-00350 RP-6795: Crank (White) | |
| Part Description | Quantity | Part Description | Quantity |
| Worm Gear | 1 | Crank (white) | 1 |
| Plug | 1 | | |
| Manual | 1 | | |
| 900-00070 CC-25HV: Retrofit Kit (Head Only) | | 900-00300 RP-6300: Directional Handle & Ceiling Plate (White) | |
| Part Description | Quantity | Part Description | Quantity |
| Antenna Decal | 1 | Spring | 1 |
| CC-25HV Manual | 1 | Decal | 1 |
| Boom Assembly | 1 | Ceiling Plate (White) | 1 |
| 55" Coax Assembly | 1 | Directional Handle (White) | 1 |
| | | Screw | 4 |
| | | Elev. Shaft & Worm Gear Repl. Manual | 1 |
| | | 900-00320 RP-6822: Spring | |
| | | Part Description | Quantity |
| | | Spring | 1 |

Updated: 29.01.2014

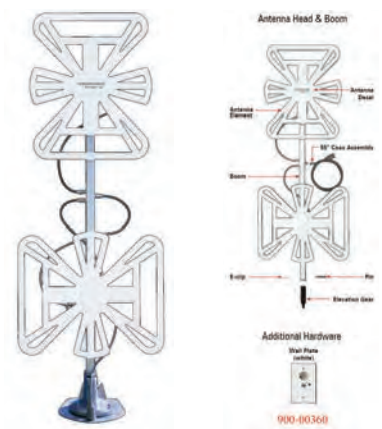

900-00392 WINEGARD 4 CABLE ENTRY PLATE



900-00394 WINEGARD 2 CABLE ENRTY PLATE

Weatherproof entry for multi-conductor cable, to be used with dual coax systems.



900-04156
CABLE ENTRY PLATE FOR WINEGARD
SATELLITE DISH

900-07318
FREEVIEW DECODER
WITH CARD READER

The smallest, most powerful high definition free to air satellite receiver available on the market.



Can be used either horizontally or vertically. USB2 port to attach USB hard drives etc. for updating firmware, channels lists and also recording and pausing live TV.

Built in Infra-Red sensor, allows the box to be hidden in a cupboard and just point the remote at the remote sensor to change channels and volume.

Ideal for the motorhome/caravan etc.

- > No tuning required
- > Factory set for 10750 LNB
- > Full instruction manual
- > Fully upgradable via software
- > Dimensions: 162W X 115D X 30H (mm)
- > Weight: 200 gm.

TELESAT HD TVS WITH FREEVIEW

Designed specifically for New Zealand, these TVs feature a built-in DVD player, DVB-S2 and DVB-T tuners, a CI slot for a Skycard adaptor and numerous inputs including: USB, SD, AV, HDMI and headphone.



SPECIFICATIONS

- Tuner Type:** DVB-S/ DVB-S2 and DVB-T/ MPEG2/ MPEG4 (H.264)
- Common Interface Support:** x1 CI slot (certain cards only)
- EPG:** Full 70day EIT EPG for Freeview
- Software Support Update:** USB
- Remote Control:** Yes (included)
- Power:** 12V/240V (Adaptors included)
- Warranty:** 2 Years

900-07400
19" HD TV/DVD TELESAT WITH FREEVIEW

900-07402
24" HD TV/DVD TELESAT WITH FREEVIEW

900-30010
24" TELESAT SMART TV

SPARE PARTS AVAILABLE TO SUIT
WINEGARD DS5 CRANK UP SATELLITE

900-07106
DIGITAL WALL PLATE DISPLAY



900-07114
CRANK HANDLE KIT



900-07112
DIRECTIONAL HANDLE KIT



900-07110
46CM REFLECTOR
FOR RP-35RM



900-07118
WORM GEAR ONLY FOR
RP-4400



900-07130
WINEGARD ELEVATING
GEAR ONLY



900-07132
WINEGARD SAT DISH WIRING
HARNES



900-07134
WINEGARD HARDWARE PKG
FOR ANTENNA TURRET



900-07200
TRIAx 10750 SINGLE LNB
FOR WINEGARD DS5



900-07202
LNB HOLDER ONLY FOR
WINEGARD DS5



ANTENNATEK SPARE PARTS

900-01102
ANTENNATEK AMPLIFIED
HEAD SERIES 550



900-01114
ANTENNATEK POWER SUPPLY
12V W/3 TV OUTLETS



900-01122
ANTENNATEK ALUMINIUM GEAR
HOUSING FOR 350



900-01124
ANTENNATEK 7/8 HEX
NYLON PLUG FOR GEAR
HOUSING

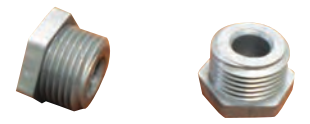

900-01140
ANTENNATEK GEAR
REPLACEMENT KIT C/W
WORM GEAR & ELEV
SHAFT



900-01142
ANTENNATEK 350
ELEVATING SHAFT ASSY



900-01150
ANTENNATEK ELEVATING
HANDLE ASSY



900-01160
ANTENNATEK ROTATION
HANDLE



900-01162
ANTENNATEK SPRING FOR
ROTATION HANDLE



900-01170
ANTENNATEK LARGE
O-RING 1"



900-01190
ANTENNATEK BASE
PLATE



900-01260
ANTENNATEK DIRECTIONAL
HANDLE KIT



FOLD AWAY ANTENNA

900-02350
STANDARD CARAVAN TV
ANTENNA

Digital ready when combined with a digital TV and set top box. Comes with 4m of cable.



900-02352
LARGE CARAVAN TV ANTENNA

Digital ready when combined with a digital off-air tuner and HD TV. Comes with 6m of cable.



900-02374
FOLDAWAY DIRECT
CONNECTOR

Direct Connector - Enables the antenna to be plugged directly into your TV, thus ending corroded/dusty and worn out connections. It is simple to use and stops signal-sapping joins, which can result in signal drop outs.



900-02376
MOUNTING KIT

Includes top clip, bottom bracket and required screws.



900-02377
MOUNTING KIT TOP CLIP ONLY

Includes x1 top clip and x2 screws



HAPPY WANDERER MASTS

900-02382
MULTIFIT BRACKET AND MAST

Suitable for use with the DT8 Dual Loop antenna range and Stand "T" antenna head. It can be fitted to your RV in a permanent or temporary manner. The permanent option fits all types of RVs including pop tops, caravans, motorhomes, slide-ons and campers. The temporary option fits pop top vans and campers with side travel clamps fitted (the clamps are used when the roof is raised). The mast is 1.4m in length (supplied as x2 70cm lengths that can be joined together via a coupling).



900-02384
EXTENSION MAST (0.7M) AND COUPLING

Used in conjunction with part #900-02382, the extension mast is available for campervans with high lifting rooves.



900-02388

HAPPY WANDERER THRU-VAN-WALL COAX CABLE CONNECTION

A waterproof, permanent solution to trailing TV antenna cables around your caravan. Made in Australia, it is ideal for use with digital set top boxes, Happy Wanderer Antennae and signal boosters as well as other branded antennae. It is adjustable to suit RV wall thicknesses from 22-35mm. Comes with rubber caps to keep out moisture.



900-02390

HAPPY WANDERER T-BAR ANTENNA

Simple to erect and stow away, the T-Bar Antenna tunes into both horizontal and vertical signals. It picks up UHF/VHF, FM Radio and digital signals and can be used in conjunction with the Signal Booster.



900-02396

PART A MULTI FIT BRACKET ONLY FOR HAPPY WANDER



900-02398

PART B MULTI FIT BRACKET ONLY FOR HAPPY WANDER



900-02403

HAPPY WANDERER DT-8 MARK 3 ANTENNA

The happy viewing continues with the improved DT-8 Mark 3 antenna. It now features an integrated diplexer which means it can combine UHF and VHF signals. The Tapered Loop Technology provides the Mark 3 with a generous beam width of 70 degrees. It is now much easier to set up and the cables cannot be fitted the wrong way. Made from UPVC plastic, the Mark 3 receives low powered DTV stations, as well as HD digital horizontal and vertical signals. It comes with a digital Thru-Van-Wall kit, all cabling (which are RG6 compression with non-corrosive plugs) and a zippered carry bag. Happy Wanderer offer a 5 year warranty on the Mark 3. Note: Brackets and masts are sold separately. You will need to retune your RV TV to suit each locations' reception.



SPECIFICATIONS

VHF MHz: channel 6-12
 UHF MHz: channel 28-69
 Max Gain: 10.4dBi (UHF), 3.1dBi (VHF)
 Dimensions (mm): 500H x 295W x 165D (with antenna rods not extended)

900-02408

SIGNAL BOOSTER AND POWER PACK (240V/ 12V COMBINATION)

It has a masthead type booster for use inside your RV. A 12V cable is included for use with a 12V power supply and the booster can be bypassed if it is not required. VHF max 15dB and UHF max 24dB gain.



900-02410

EASY-TUNE

Easy-Tune is a combined signal finder and amplifier booster. Plug your antenna into the Easy-Tune and use it to show which direction the strongest signal is coming from. Then using the handy LED indicators, the amplifier gain can be adjusted to fine tune your TV. The Easy-Tune can be permanently fixed inside your RV (perhaps inside a storage compartment). It is designed to show the presence and signal of digital or analogue TV signals and is also able to boost the received signal and distribute it to 2 outlets. Note: you should never connect 240V AC (mains voltage) directly to the Easy-Tune.



SPECIFICATIONS

Operating Voltage: 10.5 - 28V DC, 250mA max
 Outlets: 2
 Variable Gain: 5 - 19dB
 Dimensions: 16.5W x 5.5D x 2.7H (cm)
 Weight: 125g

900-02602

TELESCOPIC CLAMP

A frame clamp for telescopic pole



FURRION VISION S REAR-VISION CAMERA & DISPLAY KIT

New from Furrion, the Vision S wireless reversing camera is a high-performance vehicle observation system designed for the road as much as it was for the campsite! From reversing to changing lanes this wireless camera kit keeps an eye out for your RV! The rear-vision cameras give you a full range of view on a mountable touch screen monitor for smoother mobility while you're travelling or reversing your RV or caravan.



- > Observation systems are wireless with high-resolution touch screen monitors that can show up to four different camera images.
- > IP65 waterproof cameras
- > Rear assist reversing lines
- > 2.4GHz wireless communication digitally locks to the camera system for minimal interference.
- > Cameras offers 120-degree viewing angle, with infrared night vision.
- > The monitor can be mounted with the included windshield or universal surface mount.
- > 5" and 7" touch screen anti-glare monitors with rear assist marker lines.

900-02900 FURRION VISION S REAR-VISION CAMERA & 7" DISPLAY KIT

900-02902 FURRION VISION S REAR-VISION CAMERA & 5" DISPLAY KIT

SPHERE REVERSING CAMERA KITS

900-02688 MOTORHOME REVERSING CAMERA KIT (WITH WHITE CAMERA)

Featuring a 7", full colour monitor (which clips onto your existing rearview mirror) and a white eyeball camera. When not being used, the monitor can be used as a normal rearview mirror. The kit includes: x1 7" monitor, x1 white eyeball camera, x1 20mt extension cable. Comes with a 1 year manufacturer's warranty.



900-02690 CARAVAN REVERSING CAMERA KIT

Includes: x1 white eyeball camera, x1 7" colour monitor, x1 6mt cable, x1 20mt cable, x1 spring cable and x2 connector brackets. Comes with a 1 year manufacturer's warranty.



900-02692 MOTORHOME REVERSING CAMERA KIT (WITH BLACK CAMERA)

Featuring a 7", full colour monitor (which clips onto your existing rearview mirror) and a black eyeball camera. When not being used, the monitor can be used as a normal rearview mirror. The kit includes: x1 7" monitor, x1 black eyeball camera, x1 20mt extension cable. Comes with a 1 year manufacturer's warranty.



900-02694 CARAVAN REVERSING CAMERA KIT

Includes: x1 black eyeball camera, x1 7" colour monitor, x1 6mt cable, x1 20mt cable, x1 spring cable and x2 connector brackets. Comes with a 1 year manufacturer's warranty.



900-02771 DUAL CAMERA WIRING KIT

Includes: x1 white eyeball camera, x1 video split cable. Comes with a 1 year manufacturer's warranty.



900-02773 DUAL CAMERA WIRING KIT

Includes: x1 black eyeball camera, x1 video split cable. Comes with a 1 year manufacturer's warranty.



900-02774 SPHERE CURLY CORD KIT 3M FOR CARAVAN REVERSING KIT



900-02776 SPHERE MINI CAMERA T/S REVERSE MONITOR C/W 1 CAMERA 3M LOOM AND Y-SPLITTER LOOM



900-02785 SPHERE MONITOR LOOM T/S REVERSING CAMERA

To suit 9pin monitor connection.



900-02786 SPHERE 6M LOOM T/S REVERSING CAMERA



SAFETY DAVE

900-02810 7" MOTORHOME REVERSING CAMERA SYSTEM

Ideal for motorhomes, the package includes:

- > A 7" LCD screen with sun shield to reduce glare
- > An eyeball camera - fully waterproof and carries audio, video, and night vision infrared.
- > A 15m 4-pin cable - waterproof, carries audio, video and power.
- > A suction mount - enables you to mount your screen onto the dashboard, connects to the windscreen or any other area that allows the cup to work



(Monitor has the capacity to accept a second video input)

900-02820 5.8" CARAVAN REVERSING CAMERA SYSTEM

Ideal for caravans and horse floats, the package includes:

- > A 5.8" LCD screen with sun shield to reduce glare
- > An eyeball camera - fully waterproof and carries audio, video, and night vision infrared.
- > A 15m 4-pin cable - waterproof, carries audio, video and power.
- > A 7.5m 4-pin cable - waterproof, carries audio, video and power.
- > A suction mount - enables you to mount your screen onto the dashboard, connects to the windscreen or any other area that allows the cup to work



(Monitor has the capacity to accept a second video input)

900-02822 CAMERA & 15MT CABLE ONLY FOR REVERSING SYSTEM ROUND WHITE



900-02824 CAMERA FOR LICENSE PLATE MOUNT



900-02826
CCD BULLET EYE CAMERA



900-02830
CABLE 7.5M FOR REVERSING SYSTEM



900-02832
CABLE 10M FOR REVERSING SYSTEM

900-02833
SAFETY WOZA CABLE FOR CAMERA

A 5-pin heavy duty and flexible cable providing easy connection between vehicles and trailers. Carries audio, video, power and is waterproof.



900-50004
4K UHD WI-FI ACTION CAMERA WITH LCD. QC8071

Take this action camera with you to capture your adventures in 4K ultra high definition. Photos, video, and audio record to your favourite microSD card, which can be played back on the 2" colour LCD screen, computer, or streamed to your smart device over Wi-Fi. It has all the features you would expect in an action camera, including timer, single shot, or burst mode, timelapse, slow motion, adjustable exposure, wide angled 110° lens, with built-in microphone and speaker, and much more. It also features driving mode and loop recording if you want to use it as a car dash cam or for surveillance applications. Supplied with seven different mounts for most applications and a waterproof case to use it in and around the water to depths of 30 metres.



FEATURES

- > 30m underwater range
- > 2" LCD
- > Full HD
- > Waterproof

SPECIFICATIONS

DSP Chipset: Allwin V3
 LCD: 2"
 Image Resolution: 16M/12M/8M/5M/2M
 Timer: 3s/5s/10s/20s
 Burst: off/3/5/10
 Time Lapse (seconds): 0.5, 1, 2, 5, 10, 30, 60
 microSD Card: Up to 64GB (Not supplied)
 Audio Input/Output: Built-in Mic/Speaker
 USB Port: USB2.0, 5 Pin USB
 Battery: 900mAh Removable Li-ion battery

900-50102
16GB CLASS 10 MICRO SD CARD

This blazing-fast Class 10 Micro SDHC card holds up to 16GB of data, ideal for all your HD videos and photos. A guaranteed 10MB/s read and write speeds so you can take photos in quick succession! Includes an SD adaptor to fit in normal camera SD card slots!



SPECIFICATIONS

Type: Micro SD Card
 Capacity: 16GB
 Memory Class Standard: Class 10
 Flash Memory Write Speed: 10MB/s
 Flash Memory Read Speed: 45MB/s

900-50104
32GB CLASS 10 MICRO SD CARD

SPECIFICATIONS

Type: Micro SD Card
 Capacity: 32GB
 Memory Class Standard: Class 10
 Flash Memory Write Speed: 10MB/s
 Flash Memory Read Speed: 45MB/s



900-50122
MINI ACTION CAMERA TRIPOD WITH SMARTPHONE ADAPTOR

Get the perfect group shot on your next adventure with this Mini Tripod!

This small, lightweight tripod comes with a Smartphone adaptor mount and can attach a 1/4" action camera or GoPro® mount. It includes a handy locking adaptor that allows you to make some adjustments to your phone or action camera while it is securely mounted. A very handy and inexpensive accessory!



FEATURES

- > Smartphone adaptor mount to hold your mobile phone
- > Secure locking adaptor
- > Use your camera timer settings to take photos hands-free.

SPHERE 360 DEGREE BIRDSEYE VIEW SYSTEM

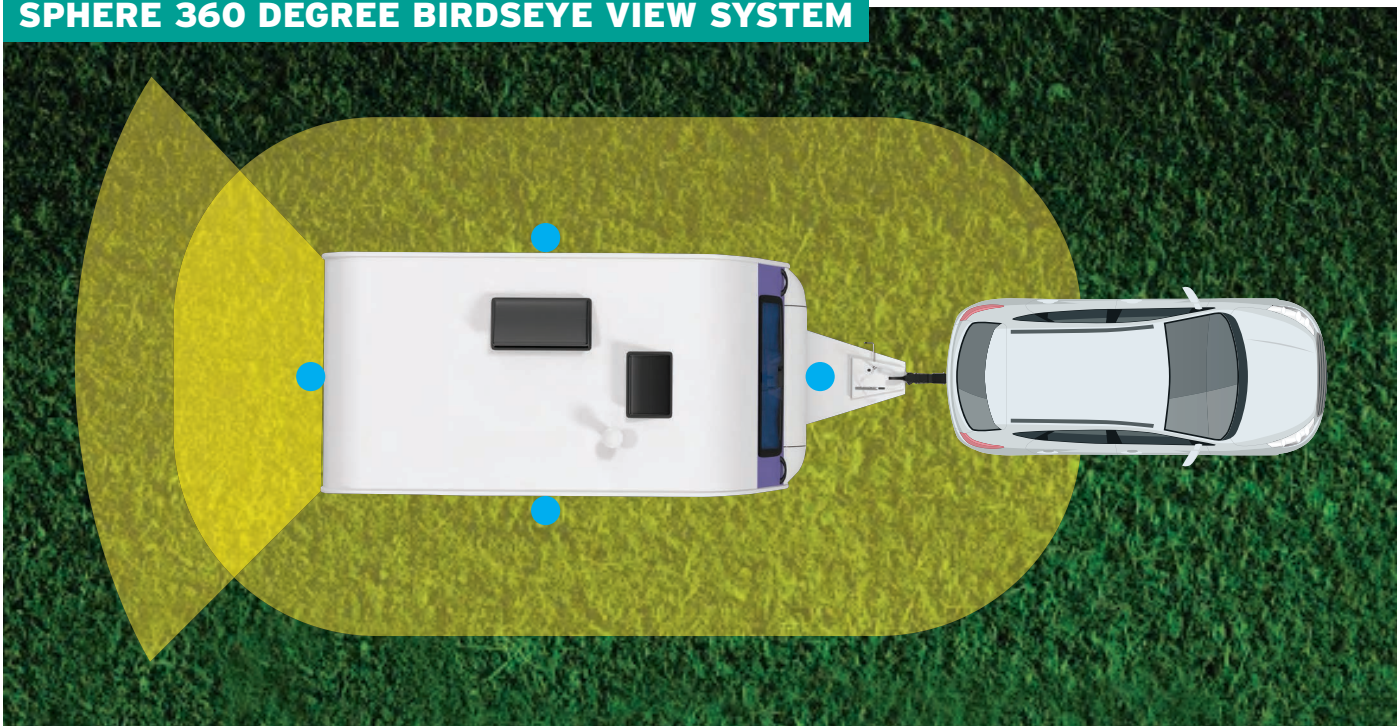

Sphere 360-degree cameras gives you a complete view of your RV, making towing and parking a breeze.

The SPHERE 360-degree Bird's Eye View system uses the inputs of four wide angle fish-eye cameras (front/rear/left/right) installed around the RV to produce a single image. The driver can intuitively observe the vehicle position and surrounding objects to assist in decision making whilst driving and towing the RV to reverse and merge lanes.

The system can also be used as a Digital Video Recorder by inserting a USB to allow continuous recording whilst driving.

900-02950

SPHERE 360 DEGREE BIRDSEYE VIEW SYSTEM

FEATURES

- > Four cameras with 180° fish-eye lens cameras to capture surrounding objects
- > 360° stitching of the 4 input cameras
- > Able to be calibrated to large variety of vehicle/RV sizes
- > System displays the 360° Bird's Eye-View image and:
 - Front camera during normal operation
 - Rear camera whilst reversing
 - Left camera when left indicator is engaged
 - Right camera when right indicator is engaged
- > The system can operate as a Digital Video Recorder (DVR) when a USB is inserted into the control module loom. Once the storage device is full, the system will begin to write over older files. These files can be viewed by inserting the USB into a laptop.



SPECIFICATIONS

CENTRAL CONTROL MODULE

CPU: Quad-core Cortex™-A7

FLASH: 4GB

Language Options: English, Russian, Japanese, Korean, Portuguese, German, Chinese, Chinese traditional.

Working Voltage Range: 9~36v

Working Current: <400mA

Standby Current: <40mA

Working Temperature Range: -30°C~ 80°C

Working Humidity: 40%~80%

CAMERAS

Effective Pixels: 1280(h) x 960(v)

Horizontal Resolution: 960H

Dynamic Range: >78dB

Video Output: AHD

Waterproof: IP67

Video Resolution: 2560 x 1440

Working Voltage: 3.3v

Working Current: <100mA

900-02960

SPHERE 360 DEGREE CAMERA CALIBRATION MAT SET

SPHERE TV BRACKETS

900-03800 SPHERE S2 BLACK SINGLE ARM TV BRACKET

The head can be tilted in all directions and has a 360° rotation capability. Nolathane bushes allow for a smooth gliding action. The arm extends up to 282mm and features a lock to limit movement whilst travelling.



SPECIFICATIONS

Weight Capacity: 15kg
Weight: 1.65kg

900-03810 SPHERE S2 BLACK DOUBLE ARM TV BRACKET

The head can be tilted in all directions and has a 360° rotation capability. Nolathane bushes allow for a smooth gliding action. The arm extends up to 422mm and features a lock to limit movement whilst travelling.



SPECIFICATIONS

Weight Capacity: 15kg
Weight: 1.92kg

900-03820 SPHERE S2 BLACK TRIPLE ARM TV BRACKET

The head can be tilted in all directions and has a 360° rotation capability. Nolathane bushes allow for a smooth gliding action. The arm extends up to 562.2mm and features a lock to limit movement whilst travelling.



SPECIFICATIONS

Weight Capacity: 9.5kg
Weight: 2.17kg

900-03850 SPHERE S2 BLACK LOCKING ARM ONLY



900-03852 SPHERE S2 BLACK WALL MOUNT BRACKET

This newly designed mounting bracket makes it easy to setup multiple viewing areas in your RV. It allows for the easy removal of the V arm which can then be relocated and easily placed into any additional mounting brackets that have been installed.



900-03856 SPHERE S2 BLACK MOUNTING BRACKET AND VESA PLATE

Mount Your TV direct to the wall of your RV with this kit. Comes with a vesa plate, bracket and necessary screws.



900-05837 SPHERE™ VESA 100X100 M4 TO 200X100 M6 CONVERSION BRACKET

This conversion bracket/adaptor is mainly for use with the 31.5" Onyx TV (part number 900-05416) if it is to be used in conjunction with a current Sphere™ silver or black wall mount bracket. Supplied with screws.

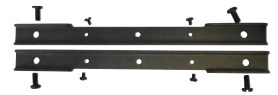

SPECIFICATIONS

Dimensions: 242L x 21W (mm)

900-05770 RUBBER AM/FM ANTENNA WITH 72" CABLE

Receives radio signals for better clarity whilst travelling. It has a 14" (35.6cm) durable rubber antenna and comes with an extension for thicker rooves. The base can swivel 180°.



SPECIFICATIONS

Cable included: 182.9cm

900-03801 SPHERE EKON QUICK RELEASE BLACK TV BRACKET KIT - STANDARD SWIVEL

FEATURES

- > Quick clip wall bracket
- > Pin-lockable
- > In built level
- > Tv cord clips

SPECIFICATIONS

Suggested Screen Sizes: up to 26"
MAX VESA: 100 mm x 100 mm (max)
Maximum Load: 20kg
Tilt Range: 13.8° up/13.8° down
Pan/Swivel Range: 360° rotation /120°swivel



900-03802

SPHERE EKON QUICK RELEASE BLACK TV BRACKET KIT - ONE ARM SWIVEL

FEATURES

- > Quick clip wall bracket
- > Pin-lockable
- > In built level
- > TV cord clips

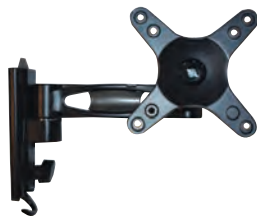

SPECIFICATIONS

Suggested Screen Sizes: up to 26"
 MAX VESA: 100 mm x 100 mm (max)
 Maximum Load: 15kg
 Tilt Range: 13.8° up/13.8° down
 Pan/Swivel Range: 360° rotation /120°swivel

900-03811

SPHERE EKON QUICK RELEASE BLACK TV BRACKET KIT - TWO ARM SWIVEL

FEATURES

- > Quick clip wall bracket
- > Pin-lockable
- > In built level
- > TV cord clips



SPECIFICATIONS

Suggested Screen Sizes: up to 26"
 MAX VESA: 100 mm x 100 mm (max)
 Maximum Load: 15kg
 Tilt Range: 13.8° up/13.8° down
 Pan/Swivel Range: 360° rotation /120°swivel

900-03821

SPHERE EKON QUICK RELEASE BLACK TV BRACKET KIT - THREE ARM SWIVEL

FEATURES

- > Quick clip wall bracket
- > Pin-lockable
- > In built level
- > TV cord clips

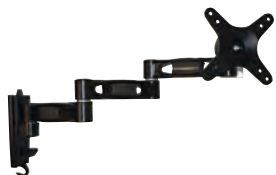

SPECIFICATIONS

Suggested Screen Sizes: up to 26"
 MAX VESA: 100 mm x 100 mm (max)
 Maximum Load: 15kg
 Tilt Range: 13.8° up/13.8° down
 Pan/Swivel Range: 360° rotation /120°swivel

900-03823

SPHERE EKON BASE ONLY (PART H.)

900-50202

NEXTECH TRANSCIVER UHF 2W 80CH PK2 BLK. DC1112

A pair of advanced 80 channel UHF transceivers for professional or recreational use. Compact in appearance but feature packed with a VOX hands-free function, CTCSS & DCS, PTT IT transmit, a group call mode, emergency alarm, and much more. An LED at the top helps shine the way at night, and an FM radio is also integrated so you can listen to important broadcasts or for entertainment purposes. A feature not seen in many other models is the Stun, Kill and Revive function. This enables you to use the second similar transceiver to send a signal that prevents unauthorised use of a lost or misplaced transceiver. The high capacity 1300mAh Li-ion battery can last up to 13 hours of average use, and a lower power mode helps extend battery life when long range communication isn't required. A mains powered charging cradle is supplied to keep the battery charged.



FEATURES

- > 476MHz UHF CB Operation Band
- > Rechargeable
- > Built-In FM Radio
- > Hands-Free Function
- > 50 CTCSS Sub-Channels
- > 208 DCS Channels
- > LED Torch

300-09006

QUADCOPTER R/C WIFI FPV 720P DRONE - 2.4GHZ. GT4146

Watch a live video feed from the high-definition camera onboard this agile remote-controlled drone as it flies in the sky above. The front facing 720p camera can be adjusted 60° from the remote control to provide a first-person view (FPV) on your Smartphone via Wi-Fi from up to 60m away. Take-off and landing are made easy using just one button, and a return home function means that you can safely get the quadcopter to return back to you before the battery runs out. The headless mode option keeps the drone moving in the same direction as the drone rotates and perform stunts, and a trajectory flight function enables you to draw a flight course on the touch screen of your Smartphone. When you have finished flying, the rotor arms fold in so it takes up less room for easy storage. The remote control has a universal phone bracket to hold your phone. A USB charging lead is supplied to charge the remote and quadcopter from an available USB power source. Spare batteries are sold separately (GT4147) so you can keep flying while your other batteries charge. Recommended for ages 14+. Note: Please use the original USB charger included inside the package when charging otherwise you may cause permanent damage to the battery.



FEATURES

- > Free iOS™ & Android App
- > Headless & Altitude Hold Mode
- > Return Home
- > One-Key Take Off & Landing
- > 720p (1280 x 720) Camera @ 20fps
- > 60° Adjustable Camera Angle

SPHERE™ S8 TVS



Built for Australian conditions and travel, the new Sphere S8 range features a Vibration Smart design specifically intended for RV applications. Smart TV functionality is available across the full Sphere S8 Range thanks to the all-new Hako Mini Box with Android TV.

900-05466
SPHERE S8 23.8" FHD ELED TV DVD COMBO WITH HAKO MINI - 12/240V

SPECIFICATIONS

Native Resolution: 1920 x 1080
 Power ON consumption: <48W
 Audio Output: x2 3W
 Input Voltage: 12V (240V Adaptor included)
 Dimensions including stand: 439 x 154 x 305mm
 Dimensions without stand: 439 x 52 x 265mm
 Weight: 4.4kg

900-05460
SPHERE S8 18.5" HD

SPECIFICATIONS

Native Resolution: 1366 x 768
 Weight: 3.5kg



900-05462
SPHERE S8 21.5" FHD

SPECIFICATIONS

Native Resolution: 1920 x 1080
 Weight: 4kg



900-05464
SPHERE S8 23.8" FHD

SPECIFICATIONS

Native Resolution: 1920 x 1080
 Weight: 4.3kg



900-05468
HAKO MINI (SMART TV BOX) - WITH ANDROID TV

FEATURES

- > Android TV streaming box transforms your TV into a smart TV.
- > Voice search remote allows for convenient operation.
- > 2.4GHz/5GHz Wi-Fi and Bluetooth 4.2 ensure a fast connection.
- > 8GB storage volume provides you more space to download your favourite movies, and browse websites more smoothly.
- > Google Assistant helps you quickly find the latest blockbuster or check the score of the big game all without leaving what you're watching
- > Cast movies, TV shows, music, games and the other content you love from your phone, tablet or laptop to your TV with built-in Chromecast.



SPHERE RG6 CABLES WITH COMPRESSION FITTINGS

Sphere RG6 Coax Cables are heavy gauge and feature excellent insulation and shielding optimized for high bandwidth, high frequency applications such as Satellite and Digital TV.

Quad Shield - Sphere RG6 cables are quad shielded meaning they have an additional layer of foil and braid shielding. This extra shielding prevents interference to your signal, preserving signal quality; especially over longer cable runs.

Compression Fittings - Sphere RG6 cables come supplied with F-Type and Pal compression fittings already fixed to the cable. This makes using and installing the cables much easier as no crimping or compression tools are required.



SPECIFICATIONS

1.02CCS 27% conductivity
4.6 FPE
Foil+72*0.16AL+AL
Foil+48*0.16AL
7.6PVC Jacket (WHITE)

900-05570
SPHERE 1.5M RG6 QUAD SHIELD COAX LEAD PAL - PAL

900-05572
SPHERE 1.5M RG6 QUAD SHIELD COAX LEAD PAL -F-TYPE COMPRESSION FITTING

900-05580
SPHERE 1.5M RG6 QUAD SHIELD COAX WITH COMPRESSION FITTINGS - F-TYPE

900-05582
SPHERE 3.0M RG6 QUAD SHIELD COAX WITH COMPRESSION FITTINGS - F-TYPE

900-05584
SPHERE 6.0M RG6 QUAD SHIELD COAX WITH COMPRESSION FITTINGS - F-TYPE

900-05586
SPHERE 10M RG6 QUAD SHIELD COAX WITH COMPRESSION FITTINGS - F-TYPE

SPHERE HDMI CABLE V2.0 HIGH SPEED WITH ETHERNET

Sphere HDMI V2.0 Cables are extremely high bandwidth capable of transmitting 18Gbps. This makes them perfect for high resolution applications such as Ultra HD 4k TV.

- > Supports Ethernet, 3D, 4K video and Audio Return Channel (ARC)
- > Connects Blu-ray players, Fire TV, Apple TV, PS4, PS3, Xbox one, Xbox 360, computers and other HDMI-enabled devices to TVs, displays, A/V receivers and more
- > Cables allow you to share an Internet connection among multiple devices without the need for a separate Ethernet cable Meets HDMI 1.4
- > Meets the latest HDMI standards (4K Video at 60 Hz, 2160p, 48 bit/px color depth) that supports bandwidth up to 18Gbps and backwards compatible with earlier versions



SPECIFICATIONS

Gauge:
1.5m - 5m : 30AWG
10m: 28 +26 AWG
15m: 28+24 AWG
Material: CCS
Pins: 19+

900-05588
SPHERE 1.5M HDMI CABLE V2.0 HIGH SPEED WITH ETHERNET

900-05590
SPHERE 3.0M HDMI CABLE V2.0 HIGH SPEED WITH ETHERNET

900-05592
SPHERE 5.0M HDMI CABLE V2.0 HIGH SPEED WITH ETHERNET

900-05594
SPHERE 10M HDMI CABLE V2.0 HIGH SPEED WITH ETHERNET

900-05596
SPHERE 15M HDMI CABLE V2.0 HIGH SPEED WITH ETHERNET

SPHERE TV FITTINGS

900-05552
SPHERE TV FITTINGS
 - MECH FEMALE PAL
 TO FTYPE FEMALE



900-05554
SPHERE TV FITTINGS
 - FEMALE FTYPE TO FEMALE
 FTYPE



900-05556
SPHERE TV FITTINGS
 - FEMALE FTYPE TO
 MALE PAL



900-05558
SPHERE TV FITTINGS
 - MALE FTYPE TO
 FEMALE FTYPE 90°



900-05560
SPHERE TV FITTINGS
 - MALE FTYPE TO
 FEMALE PAL



SPHERE TV SPLITTERS

900-05562
SPHERE TV FITTINGS
 - 2 WAY SPLITTER (DTV)
 FREQUENCY RANGE:
 5-1000HZ



900-05564
SPHERE TV FITTINGS
 - 3 WAY SPLITTER
 FREQUENCY RANGE:
 5-1000HZ



900-05566
SPHERE TV FITTINGS
 - 4 WAY SPLITTER (DTV)
 FREQUENCY RANGE:
 5-1000HZ



900-05568
SPHERE TV FITTINGS
 - ANT/SAT DIPLEXER



900-05569
SPHERE TV FITTINGS
 - MULTI SWITCH 3 IN
 4 OUT



SPHERE TV HDMI SPLITTER & SWITCH

900-05598
**SPHERE HDMI 4 WAY SPLITTER
 & USB DC LEAD**

- FEATURES
- > 1 input and 2/4 output (Splitter), 3/5 input and 1 output (Switch)
 - > 1080p HDTV Support
 - > HDCP Compliant
 - > Supports DTS,Dolby 7.1 Channel
 - > Plug n Play



900-05600
**SPHERE HDMI 5 IN 1OUT SWITCH
 & USB DC LEAD**

- FEATURES
- > Multifunctional on switching: intelligent or mechanical
 - > IR extender receiver and remote control
 - > Supports 2.5Gbps per channel and 1080p resolutions.
 - > Adaptive receiver equalization.



900-05906

LIPPERT 12VOLT TV SLIDE

The lightweight Lippert TV Lift system is easy-to-install and program, and with smart technology it can shutoff the motor in case of obstruction. The Lippert TV Lift is a great way to save on counter space and an impressive way to display your TV.



- > Easy to install with detailed guides and videos available
- > Patented worm rail design efficiently moves TV up and down
- > Easy one-button program; use the same button to program the two stopping points – programming takes less than one minute
- > Lifts TVs weighing up to 90kg
- > Requires less depth than other systems
- > Manual switch and mounting hardware included
- > 10-foot wiring harness allows for flexible installation
- > Perfect for the home as well
- > Can be used for other applications, such as cabinets or access doors

SPHERE BLUETOOTH OUTDOOR SPEAKER & LIGHT

Ideal for caravans and motorhomes, the Sphere external flush mount Bluetooth speaker & light combination is the perfect product for your RV's outdoor living space.

It features a powerful LED in a selectable choice of bright white or amber light as well as superior sound thanks to its 20 Watts of audio power. Control your soundtrack with Bluetooth and NFC functionality via your preferred compatible smart device.

The unit is weather-proof and UV stabilised to prevent premature discolouration or breakdown. It has a built-in ultrasonic mosquito repellent feature that will not interfere with hearing aid's or cardiac pacemakers and there is space allocated in the base of the unit to conceal an ONEX brand GPS tracker.

FEATURES

- > Ready to mount to your caravan or outdoor area
- > Powerful LED white/amber light
- > Mosquito repelling frequency
- > Waterproof
- > NFC and Bluetooth compatible
- > GPS tracking ready
- > UV Resistant
- > 2 Year Warranty

900-08010

SPHERE BLUETOOTH OUTDOOR SPEAKER & LIGHT - WHITE



AMAZON FIRESTICK SMART TV KIT

900-05450

AMAZON FIRESTICK SMART TV KIT - INCLUDES REMOTE & HDMI DONGLE. FIRE TV STICK



- > Great performance, picture and Dolby Atmos support - Fire TV Stick simplifies your streaming experience with convenient TV controls, for fast and powerful streaming in Full HD, plus immersive audio with Dolby Atmos support.
- > Thousands of apps - Stream for free with SBS On Demand, 10 play, 7plus, YouTube and more. Enjoy your favourites with subscriptions to Netflix, Stan, Disney+ and Prime Video. Plus watch live TV, news and sport. (Subscription may be required)
- > All-new Alexa Voice Remote with TV controls - Press and hold the voice button and easily ask Alexa to find, launch and control content. Control your compatible TV, soundbar and receiver using dedicated power and volume buttons. Quickly access your favourite content with convenient app buttons.
- > Do more with your TV - View live camera feeds, check the weather and stream millions of songs through Amazon Music, Spotify and more. Fire TV is always getting smarter with new Alexa skills and voice functionality.
- > Includes 2 AAA Batteries
- > Requires 240V power

SPHERE™ AUTOMATED SATELLITE SYSTEM



Moving with the times, the Sphere Automated Satellite System (SASS) is innovative and technologically advanced. It has been designed to locate and lock onto satellites quickly (in particular, the C1/D3 satellites which cover the majority of Australia). It is compatible with Direct Broadcast Satellites (DBS) which broadcast audio, video and data from satellites about 35,406km away! To ensure the best signal is received from DBS, the SASS must have a clear view of the satellite i.e. make sure there are no trees or heavy cloud in the signal pathway. It also has a built in Digital Broadcast Receiver. SASS comprises of two main components: the dish (which houses the positioning mechanism and twin LNBS) and the indoor unit (IDU which is the systems user interface and allows the user to control/access SASS). SASS comes with a pre-drilled mounting base plate, making it easy to install and offers better weight distribution across the RV rooftop.

**900-06002
AUTOMATED SATELLITE SYSTEM**

SPECIFICATIONS

Power: 12V
 Frequency: 10.7GHz (twin LNB)
 Closed Height: 200mm
 Size of Mounting Base Plate: 700L x 400W (mm)
Recommended Clearance (from centre of rotating head):
 600mm - surrounding items such as air conditioners or hatches must not be taller than 260mm. If surrounding items are taller than 260mm, more clearance is needed.
 450mm - surrounding items must not be taller than 190mm
 200mm - surrounding items must not be taller than 70mm
 Installed Weight: 19kg (includes cables and IDU), 16kg (dish and base plate only)

SASS Tips

1. Ensure the mounting base plate is installed on the flat surface of the RVs rooftop
2. When selecting a location to stay, make sure:
 - a. The dish has a clear line of sight to view as much of the sky as possible
 - b. The dish is at least 1.5m away from other antennas (HF, VHF and radar) that could interfere with the dish
 - c. The dishes exposure to high powered surveillance radar is minimised
3. The mounting base plate is firmly attached to the RV rooftop (Coast recommends using glue and screws) Spare parts are available if required. Please contact your local Coast Team for more information.



900-06057

VAST DSD4921RV DUAL TUNER PVR 12V/240V SATELLITE DECODER

The UEC DSD 4921 RV is already the most trusted "Next Generation" VAST™ Twin Tuner Satellite Receiver. The 4921RV was already the smallest and most versatile Dual Tuner PVR-ready VAST™ receiver. Altech UEC is still the most trusted VAST™ certified manufacturer, with the best sales and support network. The 4921RV is already the most reliable VAST™ receiver ever produced, with integrated protection against overheating, over-voltage and short-circuits. Now with new additional features you'll love, the best did get better. Now, you get extra peace of mind with 36 month Australia-wide warranty.



FEATURES

- > VAST™ Certified with over the air software upgrade for future features.
- > Smallest VAST™ Certified Set Top Box on the market, ideal for Caravan and RV enthusiasts.
- > Market leading performance with simple installation wizard and fast channel change.
- > Twin Tuner hardware supporting PVR ready functionality to ensure you never miss your favourite show whilst incorporating future proof Uni-cable LNB technology (single cable).
- > Market leading Technology and Software packed with features to make the setup, viewing and operation as easy and intuitive as possible.
- > Ruggedised design and construction to suit the harsh Australian environment with several built-in features to protect your device when connected to 240V mains, Generators or 12V DC battery installations.
- > Optional Accessories Pack for the DIY home installer or the Caravan/RV enthusiast.
- > Low power consumption for 12V DC installation and Australian MEPS (Minimum Energy Performance Standard) compliant ensuring we are environmentally responsible.
- > Backed by 20 years of VAST™ experience and national aftersales support for real peace of mind.

900-06204

06204 SATKING DVBS2-980CA VAST SET TOP BOX

The SatKing DVBS2-980CA is Australia's first VAST & Freeview Plus certified satellite TV receiver, making this unit the most advanced VAST receiver on the the market. Fully designed in Australia this top of the range receiver brings a new level of features to the VAST platform.



SPECIFICATIONS

System

CPU: STiH239

Processor: 650MHz

Flash memory: 16MB (NOR) +128MB (NAND)

SDDR: 512MB DDR2 & DDR3

EEPROM: 32 kbyte

Tuner

Standard: DVBS-EN300421, DVBS2-EN302307

Input Frequency: 950 ~ 2150 MHz

Video Decoder

Decoding: MPEG-2 MP@ML, MP@HL HD, MPEG4 H.264/AVC HD

Video Format: Pal B/G

Aspect: 16:9, 4:3

Video resolution: 576i, 576p, 720p, 1080i, 1080p

Standard: ISO/IEC 13818-3

Audio Decoder

Decoding: MPEG-1 Layer I&II, Dolby AC3, MPEG4-HE-AAC V2

Connections

Satellite Input: 2x F Type Female 75

oop Output: 2x F Type Female 75

HDMI: 1x 1.4B

YPbPr: 3x RCA

AV Out: 3x RCA

Digital Audio: 1x Optical S/PDIF, 1x Coaxial

USB: 2x USB 2.0A Type 500mA Max

Ethernet: 1x RJ-45

IR Extension: 1x 3.5mm Jack

DC Input: 1x 2.1mm Jack

Data: 1x RS232

9 Pin Din

900-06299

SATKING APPROVED 1TB PORTABLE HDD

Store your recorded shows onto this portable hard drive. Suitable for use with the DVBS2-800CA.



SPECIFICATIONS

Dimensions: 117L x 77W x 13H (mm)

SPHERE MOBILE WI-FI ROUTER



The Sphere 4G WiFi Router with GPS product gives you the flexibility of surfing the internet with ease on your travels. By inserting a SIM card, the router provides protected internet access for your family and friends.

With the in-built flash drive USB sharing feature, you will also be able to stream movies, videos, music and other file types over the router WiFi signal without consuming any data. The GPS feature allows you to obtain the location of the caravan at any time! Giving you the comfort and security to locate your caravan or motorhome when necessary.

FEATURES

- > Surf the Internet with ease on your travels
- > Share secure WiFi access to your mobile data connection
- > Stream USB or hard drive content to your devices without consuming data.
- > GPS location tracking security.

SPECIFICATIONS

Power consumption = 150mA @12V
 WiFi Range (open air) = +100 meters
 4 * LAN Ports
 1 * USB Port

900-09102
SPHERE MOBILE WI-FI
ROUTER WITH GPS - INT
ANTENNA



900-10013 FUSION MARINE STEREO UNIT AM/FM/DAB WITH IPHONE/IPOD/ANDROID/ BLUETOOTH



Introducing the MS-RA70, Fusion's sleekest value-packed marine stereo, designed to deliver a quality on-water entertainment experience by incorporating some of the latest marine technologies. The MS-RA70 is engineered to seamlessly replace any standard DIN sized non-marine stereo without the need to reconfigure dash space. Clever styling gives the installer the option of either mounting the stereo with a conventional flush finish or integrating it flat into a glass helm, ensuring a high-end finish to the installation.

SPECIFICATIONS

- Peak Power: 200W Max. (@ 4 Ω)
- Audio Zones: 2 on-board amplified zones
- Nameable Zones: Up to 10 characters per zone
- Line Out: 1 x L+R per zone (requires amplification)
- Subwoofer Out: 1 x Sub Out Linked to Zone 1 (requires amplification)
- Auxiliary Inputs: 1 x Stereo RCA Input (AUX)
- Display: 128 x 64 monochrome optically bonded LCD
- Fusion-Link Wireless: A Fusion-Link remote control app is available for compatible Apple and Android devices. Visit the Apple® App Store or Google Play™ to download the free app.
- Bluetooth Wireless Technology: A2DP Bluetooth audio streaming with AVRCP support (album art is not supported)
- USB: 1 x USB connector at the rear of the unit, supports 1 amp charging
- Audio Format USB: MP3
- Water Resistance: IPx7 water resistant from the front panel when correctly mounted.

900-10039 FUSION 6" MARINE BLACK SHALLOW MOUNT SPEAKER 150W



900-10040 FUSION 5.25" INTERNAL DUAL CONE SPEAKERS 100W (RV-FR52500EM)



Suitable for internal installations, these speakers have a super shallow mounting depth of only 31.5mm, making it perfect for installation behind RV panels.

900-10045 FUSION 6" ENCOUNTER 2 WAY SPEAKER (210W)



Stylish, black speakers with a shallow mounting depth of only 44mm. Sold in pairs, it comes with a convenient template to aid with installation and is backed by a 1yr manufacturer's warranty.

SPECIFICATIONS

- Rated Power (Watts): 40
- Frequency Response: 35 Hz - 24 kHz
- Impedance: 4 Ohm
- Sensitivity: 87 dB
- Cone Material: Polypropylene
- Tweeter: PEI
- Mounting Diameter: 126mm

900-10156 FUSION APOLLO 770 MARINE ENTERTAINMENT SYST WITH BUILT IN WI-FI.MS-RA770 (010-01905-00)



900-10094 FUSION OPTIONAL REMOTE CONTROL



900-10108 FUSION MS-NRX300 FULL FUNCTION WIRED REMOTE T/S 700 SERIES & MS-RA205



The MS-NRX300 NMEA 2000 Certified Wired Remote Control is an out of the box solution for adding localized control of a compatible FUSION marine entertainment system to any RV. The MS-NRX300 features a sleek new innovation: the glass helm flush mounting option. You can now choose either a flush mount for a stunning glass helm finish, or you can easily install with the conventional dash mount finish. Either way, the feature packed MS-NRX300 will give you everything you want from a wired remote and more.

Multi-Zone Technology

Install a remote in each independent audio zone, up to four zones depending on your FUSION entertainment system, to create localised volume control, as well as global source control. Now you have even more control in creating a customised audio entertainment experience around your vehicle.

IPx7 Waterproof

Perfect for installation inside the camper/RV, the MS-NRX300 is designed and engineered for the outdoor environment.

Optically Bonded 2.6" LCD Display

The MS-NRX300 sports a large, high contrast, daylight viewable display making it easy to navigate and stay in control of your audio entertainment experience.

FURRION AUDIOVISUAL ENTERTAINMENT



Furrion delivers innovative technology engineered, designed and tested to withstand unique performance requirements of mobile applications, including extreme weather climates and road vibrations.

FURRION 5" SPEAKERS

Our 5" outdoor speaker is made from tough, top-quality materials for high definition audio with a pure, distinct sound outdoors.

SPECIFICATIONS

Max Power: 30W
 Impedance: 4Ω
 Sensitivity: 88db
 Frequency Range: 120Hz~20KHz

900-20200
FURRION 5" BLACK
OUTDOOR SPEAKER
 Sold Singularly



FURRION 5" SPEAKER ACCESSORIES

Furrion offer black and white mounting options with their full range of 5" outdoor speakers. Additional LED Rings are now available!

Compatible with 900-20200, 900-20202, 900-20204

900-20397
FURRION LED RING FOR 5"
OUTDOOR MARINE SPEAKER
(AM)



FURRION INDOOR SPEAKERS

Our 6.5" ceiling speaker is made from top-quality materials—for high definition audio with a pure, distinct sound that's perfect indoors.

SPECIFICATIONS

Max Power: 30W
 Impedance: 4Ω
 Sensitivity: 86db
 Frequency Range: 60Hz~20KHz

900-20210 FURRION 6.5" WHITE CEILING SPEAKER

Sold Singalarly



900-20401 FURRION DV3300S HEAD UNIT W/ NFC AND BLUETOOTH CONNECTIVITY

Compact but powerful, this entertainment system with a built-in DVD player, is optimized for superior performance. With Bluetooth® connectivity and NFC quick-touch communication, it offers a next-generation multi-room entertainment experience. Enjoy multi-room music with the 2-zone entertainment system. Connect devices wirelessly with Bluetooth® and NFC quick-touch and enjoy more input options with USB, AUX-in. A built-in CD/DVD player saves space in your RV. Featuring Furrion's Vibrationsmart™ and Climatesmart™ technologies for all your adventures on the road.



- > CD & DVD
- > MP3/WMA/MP4/AVI/AM&FM
- > Bluetooth®/NFC
- > Subwoofer connection
- > USB with charging
- > Control by Furrion ES Control app
- > Vibrationsmart™ & Climatesmart™

900-20405 FURRION DV5700S HEAD UNIT W/ BLUETOOTH 5.0 CONNECTIVITY



This sophisticated system is designed to deliver a personalized experience wherever your travels take you. Featuring a built-in DVD player with exceptional media quality, and a USB port that offers easy access and digital playback of your favourite music from USB storage devices, this stylish system is always ready to come along for the ride.

- > Bluetooth 5.0
- > USB Interface
- > Memory card reader
- > Climatesmart™
- > Auxiliary input
- > Vibrationsmart™
- > Subwoofer out
- > Works with unimote
- > Signalsmart

900-20600 FURRION F-TYPE TV INLET/OUTLET BLACK

- > Snap-in F-type connector
- > Coax connectors ideal for satellite and cable feed
- > Durable UV stabilized polyester material
- > Nickel plated brass connector for improved signal transmission and corrosion resistance
- > Satellite compatible
- > Easy installation
- > Wall mount with screws
- > Weatherproof sealing
- > Designed for outdoor applications



FURRION PORTABLE BLUETOOTH SPEAKER

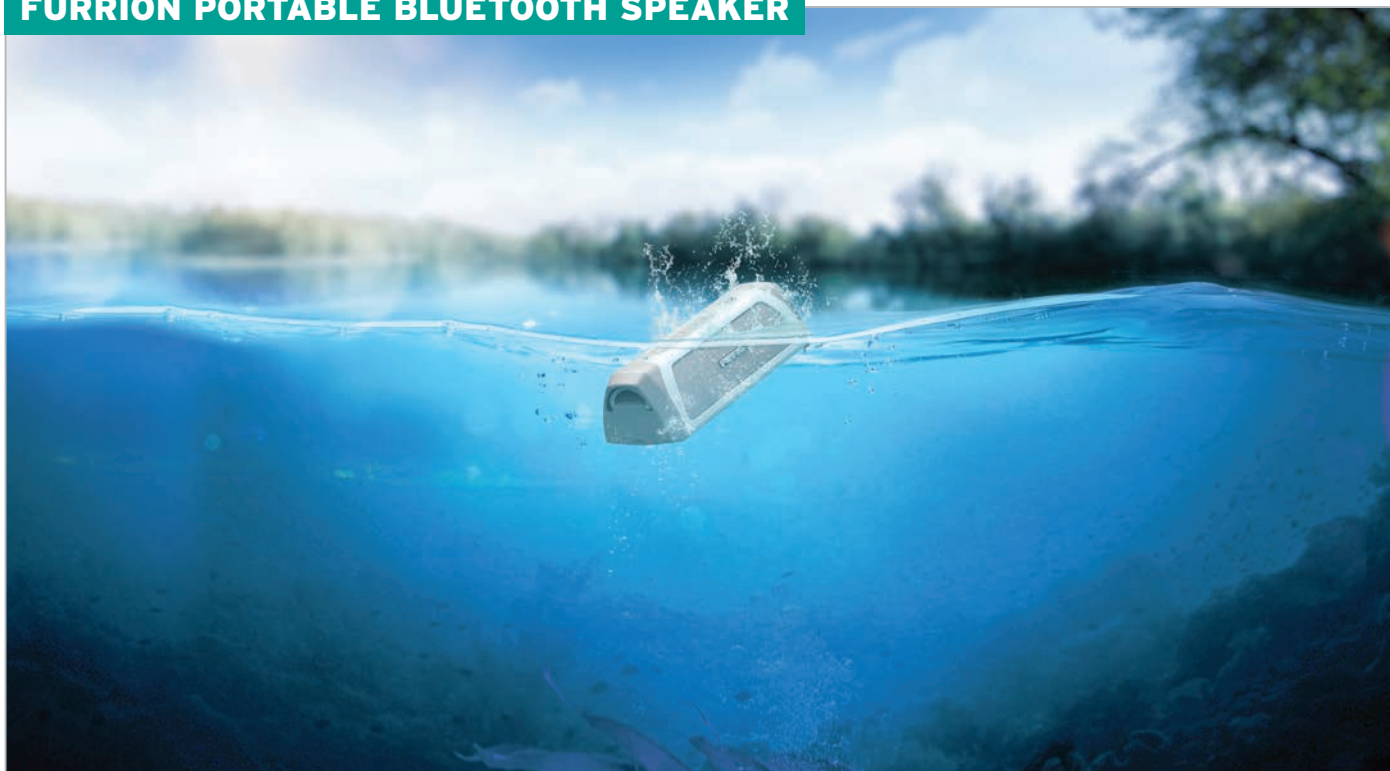

The all new FURRION LIT was created for mobile and adventurous living, the portable Bluetooth® speaker is compact, big on sound and features a rugged design so you can take it anywhere.

Designed for mobile and adventurous living, the Furrion LIT portable Bluetooth speaker is compact in size and big on sound. Its unique rugged design is waterproof, shockproof, sand proof, comes with a built-in flashlight and has up to 15 hours of play time. LIT can be mounted in an RV so you can take the party anywhere. The mount is simple to install, acts as a charging station and secures the speakers when you're on the road.

FEATURES

- > Playtime Up to 15 hours
- > Torch Light
- > Waterproof IPX7
- > Bluetooth
- > NFC
- > Speaker Phone
- > Micro USB Inputs
- > USB Charging Out

SPECIFICATIONS

Rated Power 10W x2 RMS
 Battery 1800mAH x2
 Signal To Noise Ratio ≥80dB
 SOS Light Effect Yes

900-20702 FURRION PORTABLE BLUETOOTH SPEAKER - WHITE



900-20750 FURRION WIRELESS CHARGING DOCK FOR PORTABLE BLUETOOTH SPEAKER



ROKK MINI

900-15058 ROKK MINI TABLET MOUNT KIT WITH SUCTION CUP BASE. RLS-508-405

ROKK Mini is a compact and multi-adjustable mounting system for tablets and smartphones. Small in size but big on features, ROKK Mini is simply the toughest, most reliable mount for your tech onboard. No compromise. For devices up to 1.2KG at 6g



PRODUCT INFORMATION

1) Tablet Clamp Top Plate
Secure mount for mini and full-size tablets - ratchet adjustable.
Fits devices from 125mm to 220mm (5-8 1/4")

2) 360° BODY

Install your devices instantly onboard. With one reassuring click, your tech is both secured and released. A metal-on-metal locking system multiplies your clamping efforts to achieve 100% locking force. Your electronics will never move until you want them to.

3) SUCTION CUP BASE

Fits to any rigid, clean, smooth, non-textured surface. Tough, marine-grade, UV stable materials. Mounts quickly with over-centre locking arm. No tools required. Safety lock prevents accidental release when ROKK Mini adjustable body is attached

900-15040 ROKK MINI SCREW DOWN BASE. RLS401

It doesn't get much tougher than this. ROKK versatile screw down base fits any flat surface. Works with all ROKK Mini top plates and the RLS-AM ROKK Mini Body.



900-15042 ROKK MINI RAIL BASE. RLS-402

ROKK Rail Mount Base fits a wide range of rail and works with all ROKK Mini top plates and the RLS-AM ROKK Mini Body. Fits wide range of rails from 19mm - 34mm. Includes 3 x soft rail grip pad inserts for the perfect fit.



900-15044 ROKK MINI RAIL BASE. RLS-402

Over-size rail mount base for the ROKK Mini mounting support. Fits wide range of non-standard rail sizes. Secured with 2 cable ties. The Cable Tie Kit enables you to mount your tablet onto over-sized rails and other tubes and sections, minimum diameter 60mm (2.3") and maximum diameter 100mm (3.9").



900-15046 ROKK MINI SELF-ADHESIVE BASE. RLS-404

3M self-adhesive base mount. Fits any flat surface. No drilling required to install.



900-15048 ROKK MINI SUCTION CUP BASE. RLS-405

ROKK high strength, outdoor-ready Suction Cup is engineered better for longer lasting grip. Fits to any rigid, clean, smooth, non-textured surface.



950-00026
SUBURBAN SW6DRA HOT WATER SYSTEM - 20.3L
CAPACITY - DIRECT SPARK LPG

SPECIFICATIONS

Capacity: 20.3L
 Max working pressure: 700Kpa
 Hourly gas consumption: 8.7mj/hour
 Test point pressure: 2.63Kpa
 Jet orifice size: 0.84mm
 Type of heating medium: Universal Gas
 Recovery: 40L/hr 45°C rise
 Electrical: For automatic gas ignitor 12V DC
 Dimensions: 320W x 320H x 500D (mm)



| Item No. | Part No. | Description |
|----------|------------|---|
| 1 | 950-02522 | Module Board |
| 3 | 950-02532 | Cover, Module Board |
| 12 | 950-01123 | Valve Pressure Relief |
| 15 | 950-02622 | Cover, Thermostat/Hi-Limit |
| 20 | 950-02539 | Bracket, Electrode Mounting |
| 21 | 950-02538 | Electrode |
| 26 | 950-01244 | Burner Assembly with orifice |
| 27 | 950-01258 | Air Shutter Assembly (Main Burner) |
| 28 | 950-02691 | Electric Element with Gasket |
| 29 | 950-01140 | Anode |
| 34 | 950-02670 | Gas Fitting |
| 36 | 950-02632 | Valve, Gas (LP) |
| 37 | 950-01174 | Manifold, Outlet |
| 41 | 950-02600 | Switch Assembly, 12 V.D.C. T-Stat/Hi-Limit |
| 42 | 950-02612 | Switch Assembly, 220 V.A.C. T-Stat/Hi-Limit |
| 45 | 950-01390 | Grommet, Gas Inlet |
| 51 | 950-02500 | Switch, Lamp and Plate Assembly |
| 55 | Z950-01380 | 1/4 Loxit Nut (Manifold to Burner) |
| 56 | Z950-01380 | 1/4 Loxit Nut (Manifold to Valve) |
| 57 | 950-02540 | Electrode Wire (Not Shown) |
| 59 | 950-02697 | Cover, Element |
| 63 | 950-02542 | Plug Break Through |

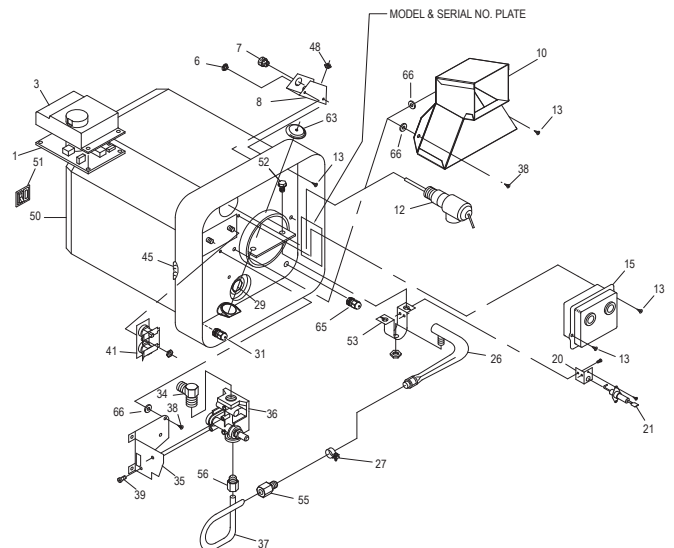

950-00036

SUBURBAN SW6DERA HOT WATER SYSTEM - 20.3L CAPACITY - 12V/240V/LPG

Has a 12V ignitor and operates on Universal gas and 240V. User is able to control which operation is sourced by means of an internal switch for gas and an external switch for electricity.

SPECIFICATIONS

Capacity: 20.3L

Max working pressure: 700Kpa

Hourly gas consumption: 8.7mj/hour

Test point pressure: 2.63Kpa

Jet orifice size: 0.84mm

Type of heating medium: Universal Gas/240V

Recovery: 40L/hr 45°C rise

Electrical:

- For auto gas ignitor: 12V DC
- For models with 240V: 240V - 50HZ AC heating element
- Element rating: 1440W - 6A

Dimensions: 320W x 320H x 500D (mm)

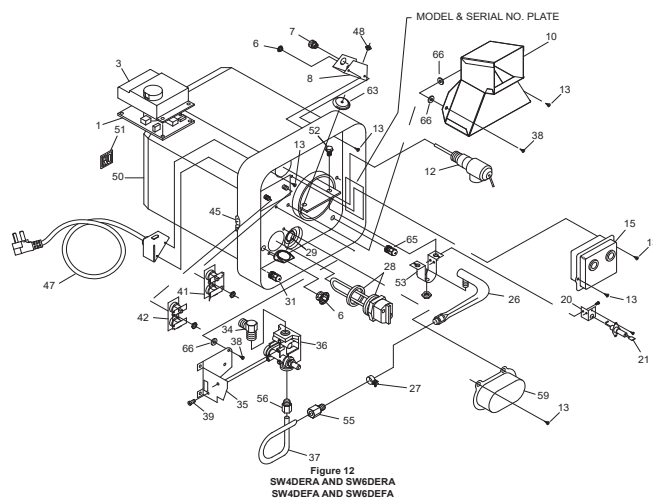

| Item No. | Part No. | Description |
|----------|------------|---|
| 1 | 950-02522 | Module Board |
| 3 | 950-02532 | Cover, Module Board |
| 12 | 950-01123 | Valve Pressure Relief |
| 15 | 950-02622 | Cover, Thermostat/Hi-Limit |
| 20 | 950-02539 | Bracket, Electrode Mounting |
| 21 | 950-02538 | Electrode |
| 26 | 950-01244 | Burner Assembly with orifice |
| 27 | 950-01258 | Air Shutter Assembly (Main Burner) |
| 28 | 950-02691 | Electric Element with Gasket |
| 29 | 950-01140 | Anode |
| 34 | 950-02670 | Gas Fitting |
| 36 | 950-02632 | Valve, Gas (LP) |
| 37 | 950-01174 | Manifold, Outlet |
| 41 | 950-02600 | Switch Assembly, 12 V.D.C. T-Stat/Hi-Limit |
| 42 | 950-02612 | Switch Assembly, 220 V.A.C. T-Stat/Hi-Limit |
| 45 | 950-01390 | Grommet, Gas Inlet |
| 51 | 950-02500 | Switch, Lamp and Plate Assembly |
| 55 | Z950-01380 | 1/4 Loxit Nut (Manifold to Burner) |
| 56 | Z950-01380 | 1/4 Loxit Nut (Manifold to Valve) |
| 57 | 950-02540 | Electrode Wire (Not Shown) |
| 59 | 950-02697 | Cover, Element |
| 63 | 950-02542 | Plug Break Through |

950-00046

SUBURBAN 240V ONLY HWS WITH DOOR (SW5EA)

Operates on electricity only.

SPECIFICATIONS

Capacity: 17.7L

Max working pressure: 700Kpa

Type of heating medium: 240V

Recovery: 21L/hr 45°C rise

Electrical:

- For models with 240V heating element: 240V - 50HZ AC

- Element rating: 1440W - 6A

Dimensions: 320W x 320H x 450D (mm)



| Item No. | Part No. | Description |
|----------|-------------------|---|
| 1 | 950-01123 | Valve, Pressure Relief |
| 2 | 950-02622 | Cover, Thermostat/Hi-Limit |
| 3 | 950-02624 | Gasket, Thermostat Cover |
| 8 | 950-02691 | Electric Element with Gasket |
| 9 | 950-01140 | Anode |
| 14 | 950-02612 | Switch Assembly, 220 V.A.C. T-Stat/Hi Limit |
| 20 | Z950-01402 | Foam Jacket (2 Required) SW5EA |
| | Z950-01412 | Foam Jacket (2 Required) SW7EA |
| 25 | 950-02542 | Plug, Break Through |

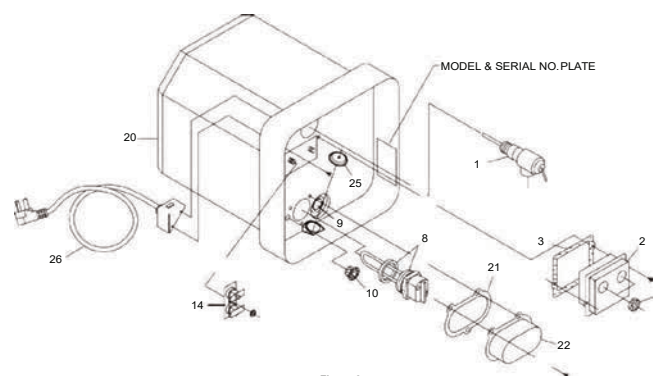

Figure 8

950-00056

SUBURBAN SW4DERA HOT WATER SYSTEM - 15.1L CAPACITY - 12V/240V/LPG

Has a 12V ignitor and operates on Universal gas and 240V. User is able to control which operation is sourced by means of an internal switch for gas and an external switch for electricity.

SPECIFICATIONS

Capacity: 15.1L

Max working pressure: 700Kpa

Hourly gas consumption: 8.7mj/hour

Test point pressure: 2.63Kpa

Jet orifice size: 0.84mm

Type of heating medium: Universal Gas/240V

Recovery: 40L/hr 45°C rise

Electrical:

- For auto gas ignitor: 12V DC

- For models with 240V heating element: 240V - 50HZ AC

- Element rating: 1440W - 6A

Dimensions: 320W x 320H x 450D (mm)

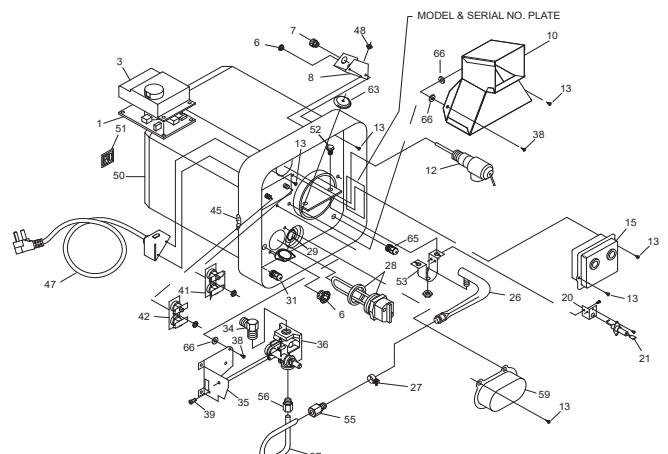

Figure 12
SW4DERA AND SW6DERA
SW4DEFA AND SW6DEFA

| Item No. | Part No. | Description |
|----------|------------|---|
| 1 | 950-02522 | Module Board |
| 3 | 950-02532 | Cover, Module Board |
| 12 | 950-01123 | Valve Pressure Relief |
| 15 | 950-02622 | Cover, Thermostat/Hi-Limit |
| 20 | 950-02539 | Bracket, Electrode Mounting |
| 21 | 950-02538 | Electrode |
| 26 | 950-01244 | Burner Assembly with orifice |
| 27 | 950-01258 | Air Shutter Assembly (Main Burner) |
| 28 | 950-02691 | Electric Element with Gasket |
| 29 | 950-01140 | Anode |
| 34 | 950-02670 | Gas Fitting |
| 36 | 950-02632 | Valve, Gas (LP) |
| 37 | 950-01174 | Manifold, Outlet |
| 41 | 950-02600 | Switch Assembly, 12 V.D.C. T-Stat/Hi-Limit |
| 42 | 950-02612 | Switch Assembly, 220 V.A.C. T-Stat/Hi-Limit |
| 45 | 950-01390 | Grommet, Gas Inlet |
| 51 | 950-02500 | Switch, Lamp and Plate Assembly |
| 55 | Z950-01380 | 1/4 Loxit Nut (Manifold to Burner) |
| 56 | Z950-01380 | 1/4 Loxit Nut (Manifold to Valve) |
| 57 | 950-02540 | Electrode Wire (Not Shown) |
| 59 | 950-02697 | Cover, Element |
| 63 | 950-02542 | Plug Break Through |

950-01140

SUBURBAN ANODE ROD FOR ALL SUBURBAN HWS

All Suburban HWS' have an anode rod which absorbs all the corrosive action of hot water. It is located on the bottom of the HWS (under the main burner), simply unscrew this to drain the tank of water. If the rod is mostly eaten away, replace it with a new one. The Suburban anode rod fits the 4, 5 and 6 gallon tanks.



Did you know?

There are many anode rods on the market. Cheaper imitations may not always be the best fit for a Suburban HWS. Not only are some imitations the incorrect length, you also need to be wary of the thread type (at the head of the rod). The Suburban range of HWS's are made in the USA and they use the NPT style thread for the anode.

Most other parts of the world use a BSP style thread. If a BSP threaded anode rod is fitted into a Suburban HWS it will damage the pitch on the internal thread and cause future leaks. Coast always recommends using a Suburban anode rod in a Suburban HWS.

950-01148

PREMIUM MAGNESIUM ANODE ROD T/S SUBURBAN TANK HWS - SKIN PACK

The Premium Magnesium Anode Rod is made for use in the 4, 5 & 6 Gallon tanks and feature a 304 stainless steel core for increased durability.



SUBURBAN EXTERIOR DOORS

Suburban exterior doors stand up to the elements and frequent use, with corrosion-resistant steel finished in a tough, high-solids baked enamel for extra chip resistance. Coast to Coast stock the standard doors which are installed without bending flanges or installing corner gussets for easy installation and a superior seal.

950-01304

SUBURBAN POLAR WHITE DOOR

For SW5DEA Water Heater.



950-01308

SUBURBAN POLAR WHITE DOOR

Suitable for SW6PA, SW6DA, SW6DEA and SW4DEA.



950-01312

SUBURBAN ARCTIC WHITE AUS VERSION RADIUS CORNER DOOR T/S

SW4&6DERA/DRA. 6282AAW



950-01314

SUBURBAN BLACK DOOR

Suitable for SW6PA, SW6DA, SW6DEA and SW4DEA.



SPECIFICATIONS

Dimensions (overall): 381W x 381H (mm)

950-01316

SUBURBAN EBONY BLACK AUS VERSION RADIUS CORNER DOOR T/S

SW4&6DERA/DRA. 6282AEB

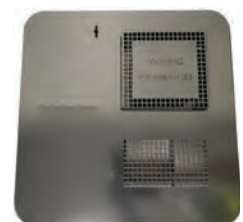

950-01320

SUBURBAN PLASTIC DOOR LATCH CLIP ONLY (WHITE)

A replacement latch suitable for use on all Suburban HWS Doors.



950-01324

SUBURBAN PLASTIC DOOR LATCH CLIP ONLY (BLACK)

For all models.



950-02500

SUBURBAN SWITCH & PLATE ASSY WHITE

For SW6DA/DEA.233495/ old 232589

SUBURBAN HOT WATER HEATER FAQs

Are all Suburban Water Heaters equipped with an Anode Rod? What is its function? When should it be changed?

YES - all Suburban water heaters feature an anode rod. The anode equalizes aggressive water action, providing cathodic protection for the tank. It is a very important factor in tank life and should only be removed for inspection, draining or replacement. It is removable using a 1-1/16" thin wall socket. Under normal use, the anode rod will deteriorate. Because of this, we recommend it be replaced bi-annually or when consumption or weight loss of the rod is greater than 75%.

Note: Water with high levels of iron &/or sulphate will increase the rate of deterioration. To extend anode life, drain water from tank whenever the RV is not being used. Avoid any extended time of non-use with water in the tank.

Why does water drip from my water heater's pressure and temperature (P&T) relief valve?

You may experience water weeping or dripping from your water heater's pressure and temperature (P&T) relief valve when your water heater is operating. Water weeping or dripping does not mean that the P&T valve is defective. As water is heated, it expands. The water system in an RV is a closed system and does not allow for the expansion of heated water. When the pressure of the water system exceeds the relieving point of the P&T valve, the valve will relieve the excess pressure.

Can I add-on an electric element to a PA/DA Model (GAS ONLY Unit)? What will happen if I use it?

NO - the use of these aftermarket heating element devices may result in damage to components or the water heater. When aftermarket heating elements are inserted into the anode rod/drain connection, tank life is shortened by accelerating inner tank corrosion. This will be a non-warrantable situation. An upgrade is required to a GAS/ELECTRIC model, for this application.

What if I operate the water heater without water in the tank?

Operation without water in the tank on the 12V DC gas portion of the water heater can cause the copolymer insulation jacket to melt and can cause the ECO/Thermostat to trip. Operation without water in the tank on the 230V AC electric portion of the water heater will damage the element.

There is a bad odour coming from the hot water faucet. How can I correct this?

Odour from the hot water system is not a service problem and many water supplies contain sufficient amounts of sulphur to produce an odour. The odour is similar to rotten eggs and is often referred to as "sulphur water". Sulphur water is not harmful—only unpleasant to smell. Sulphur water can be caused by a chemical action or by bacteria. The key to eliminating this smell is heavy chlorination of the water system. Add about 177ml of chlorine (common household liquid bleach) to each 10 gallons in the water

tank. Then run the heavily chlorinated water throughout the system, opening each faucet one at a time until you smell the chlorine. Let the RV sit a few days and the chlorine should take care of the problem. Then you will need to remove the chlorine by flushing the water system. If you don't have a water filtration system that removes chlorine, you may have a problem getting rid of the chlorine taste. You might consider adding such a system because it allows you to keep water chlorinated and this prevents several problems, including sulphur water. Chlorination also takes care of other types of bacteria and viruses.

How do I drain my water heater?

Follow the steps below:

1. Turn off electrical power to the water heater either at the switch from the electric element or a breaker.
2. Shut off the gas supply to the water heater.
3. Turn off the pressure pump on the water system.
4. Open both hot and cold water faucets.
5. Remove the anode rod from the tank. (NOTE: TAKE CARE as water may be HOT when drained from the unit).
6. Follow the RV manufacturer's instructions for draining the entire water system.

950-02700

CAMCO SCREW-IN ELEMENT WRENCH 5" FOR SUBURBAN HWS

This zinc-plated element wrench goes where other wrenches can't, allowing you to remove and replace screw-in elements with ease. It works in conjunction with your screwdriver and fits all 5" regular screw-in elements and 1-1/2" nuts.



950-02710

CAMCO T & P UNIVERSAL VALVE REMOVER

Replace temperature and pressure valves faster and more safely. The Valve Remover gives you better access to the water heater housing, reducing injuries. Fits Atwood and Suburban (Mor-Flo) water heaters



950-02720

CAMCO HWS TANK RINSER

Cleans the sediment that collects at the bottom of your water heater and flushes it out. Note, please use 800-01992 to connect the Tank Rinser to your garden hose.



950-02730

TUBE SPANNER 1 1/16" X 1 1/2" 250MM OVERALL LENGTH FOR SUBURBAN HWS

This two in one tool will work with Genuine Suburban Anodes and Heat Elements.

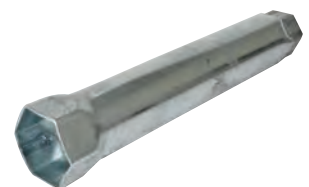

NAUTILUS IW60A ON DEMAND WATER HEATER



Enjoy endless hot water with Suburban's NAUTILUS On Demand RV Water Heater. Say "good-bye" to waiting for water to reheat in a conventional tank. Showers and baths are best enjoyed slowly, so live free from the restraints of limited hot water supplies. Dishes and even the laundry can be done with an infinite supply of hot water whenever and wherever, simultaneously from every fixture.

With no storage tank to heat water, the NAUTILUS On Demand RV Water Heater reduces weight and increases efficiency by only operating when the need for hot water arises. The NAUTILUS On Demand RV Water Heater uses an exclusive 60,000 BTU 2-Stage Modulating Combustion System (MCS) which instantaneously adjusts the LP gas input to provide consistent and endless comfort regardless of your hot water needs.

950-03000
SUBURBAN'S NAUTILUS ON DEMAND WATER HEATER

- developed with **INDUSTRY-BEST:**

- > Exclusive 60,000 BTU Two-Stage Self Modulating Combustion System
- > Built-In Freeze Protection
- > Only 16.3kg Installed
- > Two-Year Limited Warranty



The EXCLUSIVE 2-Stage Modulating Combustion System (MCS) Monitors:

- > Inlet water temperature
- > Inlet water flow
- > Output water temperature
- > Combustion air fan speed
- > Heat exchanger & burner operation

SUBURBAN NAUTILUS CONTROL CENTRE

The On Demand Control Center provides precise temperature control, reliable and consistent comfort from the convenience of your RV.

950-03500
SUBURBAN NAUTILUS CONTROL CENTRE - WHITE



950-03502
SUBURBAN NAUTILUS CONTROL CENTRE - BLACK



SUBURBAN NAUTILUS VENTS

A Suburban replacement panel and vent cap are required when replacing Suburban 6, 10, 12, and 16 gallon tank units with the NAUTILUS On Demand RV Water Heater.

950-03504
SUBURBAN NAUTILUS VENT FOR
0 - 2.5CM (0 - 1 INCHES) WALL
THICKNESS



950-03506
SUBURBAN NAUTILUS VENT FOR
2.5 - 5.0 CM (1 - 2 INCHES) WALL
THICKNESS



950-03508
SUBURBAN NAUTILUS VENT FOR
5.0 - 7.6 CM (2 - 3 INCHES) WALL
THICKNESS



950-03512
SUBURBAN NAUTILUS
ACCESS DOOR
6 GAL - BLACK



950-03514
SUBURBAN NAUTILUS
ACCESS DOOR
10 GAL - WHITE



950-03516
SUBURBAN NAUTILUS
ACCESS DOOR
10 GAL - BLACK



950-03518
SUBURBAN NAUTILUS
ACCESS DOOR
6 GAL ATWOOD - WHITE



950-03520
SUBURBAN NAUTILUS
ACCESS DOOR
10 GAL ATWOOD - WHITE



SUBURBAN NAUTILUS ACCESS DOORS

Please note: The images below are shown with the vent cap installed for illustration purposes only. Replacement Panels and Vent caps are sold separately. The Suburban 10 Gallon Replacement panel is used for 10, 12 or 16 gallon capacity unit installations.

950-03511
SUBURBAN NAUTILUS
ACCESS DOOR
6 GAL (22.7 LITRE)
ARCTIC WHITE

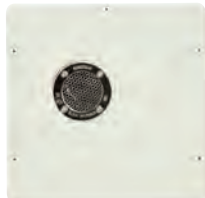

Installation Configuration Examples

The NAUTILUS On Demand RV Water Heater from Suburban is a truly adaptable platform that offers a variety of installation options to suit your needs. The below configurations examples demonstrate the NAUTILUS system's industry leading versatility.

Example Configuration 1

The minimum specification install of the Nautilus system required only the system itself and a single vent to suit your vehicles wall thickness. Please note that the unit should be installed as close to wall as possible.



Example Configuration 2

The maximum specification install of the Nautilus system requires the system itself, the Nautilus Control Centre (available in black or white), a single vent to suit your vehicles wall thickness and a single access door.



| PERFORMANCE SPECS | SUBURBAN NAUTILUS |
|---|--|
| Model | Nautilus IW60A, 5187A |
| Maximum Mj/Hr | 64 (5) burners |
| Two-Stage Self Modulating Combustion System | YES Stage 1 Operation: 2 Burners Stage 2 Operation: 5 Burners |
| Fuel Source | Universal LP Gas |
| Dry Weight | 15 kg with vent assembly Optional access panel 2.3 Kg shipping weight |
| 12 VDC = AMPS | 2.1 AMPS |
| Operational Voltage Range | 10.2 - 14.5 VDC |
| MAXIMUM Output Water Temperature | 50°C |
| Output Water Temperature - Factory Setting | 50°C |
| Digital Control Center Temperature Range | 35° - 50° (C) |
| Liters Per Minute (LPM) Required Flow | 1.9 LPM |
| Freeze Protection | Standard |
| Warranty | 2 - Year |
| Product Dimensions | 316.6 mm W x 317.8 mm H x 464.9 mm D (includes inlet & discharge water lines) |

Water Temp. Heat Gain From Incoming Water Temp.

| Input Water Temp | LPM | Output Water Temp | Gain |
|------------------|------|-------------------|------|
| 10° | 5.7 | 48° | 38° |
| | 7.6 | 38° | 28° |
| | 11.4 | 29° | 19° |
| 15° | 5.7 | 48° | 33° |
| | 7.6 | 43° | 28° |
| | 11.4 | 35° | 20° |
| 21° | 5.7 | 50° | 29° |
| | 7.6 | 49° | 28° |
| | 11.4 | 39° | 18° |

| | |
|--------------------------|----------------|
| 12 Volt Compressor | 186, 187 |
| 12V Awnings | 36, 37, 41, 42 |
| 12V Fridge Fan | 238 |
| 12V Gas Detector | 203 |
| 12V Water Pumps | 260 - 263 |
| 15 AMP - 10 AMP Adapters | 182, 183 |
| 15A Leads | 179 |
| 3 Stage Camper Lifter | 50 |
| 3-Way Fridges | 243 |
| 4k Camera | 315 |

A

| | |
|----------------------------------|-------------------------|
| AC41 Water Filler | 266 |
| Access Doors | 208, 209, 210, 212, 213 |
| Accumulator Tanks | 280 |
| Action Camera | 315 |
| Adapter Brackets - Fiamma | 20, 21 |
| Adapters - Waeco | 238 |
| Adco RV Covers | 120, 121 |
| Adco Tyre Guards | 121 |
| Adhesive | 219, 220 |
| Adjustable Ball-Mount Attachment | 94 |
| Adjustable Roof Rack | 117 |
| Aero Flo Vent Cover | 227 |
| Aeroplus Wind Deflector | 147 |
| Air Compressor | 186, 187 |
| Air Conditioner Gasket | 4 |
| Air Conditioners | 4, 5, 6 |
| Air Pump | 186, 187 |
| Alarmed Trailer Lock | 131 |
| Alko Bearing Kits | 137 |
| Alko Brakes | 136, 137 |
| Alko Corner Steadies | 143, 144 |
| Alko Couplings | 143 |
| Alko Jockey Wheels | 129 |
| Alko Water Tank | 269 |
| Aluminium - Truline | 51 |
| Aluminium Cladding | 53 |
| Aluminium H-Frame | 4 |
| Aluminium Step | 133, 134 |
| Amp Fibian Surge Protector | 183 |
| AmpFibian Adapters | 182, 183 |
| Anbi | 159 |
| Anderson Plugs | 178 |
| Annex Awning | 12 |
| Annex Door Roller | 26 |

| | |
|-------------------------------|-------------------------|
| Annex Matting | 28 - 30 |
| Anode Rod | 335 |
| Antenna Diplexer | 324 |
| Antenna Outlets | 178 |
| Antennae | 306 - 312 |
| Anti-Flap Kits | 23 |
| Anti-Theft Kit | 147 |
| Anti-Theft Locks | 130, 132, 147, 148 |
| Aqua Kem Blue | 290 - 292 |
| Aqua Kem Green | 290 - 292 |
| Aqua Kem Sachets | 291 |
| Aqua Rinse | 290 - 292 |
| Aqua Soft Toilet Paper | 293 |
| Argent HOBs | 247 |
| Argent Sink | 281 |
| Ark Bearing Kits | 137 |
| Ark Jockey Wheels | 131 |
| Ark Tow Balls | 70 |
| Assist Handles | 160, 161 |
| Astro Annexe | 13 |
| Audio Entertainment | 322, 326, 327, 328, 329 |
| Aussie Traveller AFK | 23 |
| Aussie Traveller Black | 23 |
| Aussie Traveller Rafters | 26 |
| Aussie Traveller Spares | 26 |
| Australite Four Seasons Hatch | 223, 224 |
| Automated Satellites | 323 |
| Auxiliary Showers | 284, 285 |
| Awning Adapter | 22 |
| Awning Cleaner | 217 |
| Awning Hardware | 36, 39, 42 |
| Awning Hooks | 24, 62 |
| Awning Leg Brackets | 22 |
| Awning Lights | 160, 161 |
| Awning Rafters | 20, 26, 38 |
| Awning Rain Guards | 21 |
| Awning Repair Tape | 25 |
| Awning Stabiliser Kits | 22, 24, 25, 62 |
| Awning Support Cradle | 43 |
| Awning Tiedowns | 22, 24, 25, 62 |
| Awnings | 14 - 20, 36 - 46 |

B

| | |
|------------------|-----|
| Bag Awning Poles | 28 |
| Ball Level | 140 |
| Ball Valves | 203 |

INDEX

| | | | |
|-----------------------------------|---------------|---------------------------------------|------------|
| Ball Weight Scales | 145 | Break Away Kits | 79 |
| Barbeque | 252 | Break Away Switches | 77, 78, 79 |
| Barbeque Slide Kit | 252 | Breaksafe Components | 77, 78, 79 |
| Barbs | 262 | Breha Hand Pumps | 285 |
| Bargman Lights | 160 | Briggs & Stratton Generator | 197 |
| Base Plate | 146 | Briggs & Stratton Inverter Generators | 197 |
| Bathroom Cleaner | 291 | Brooms | 107 |
| Bathroom Fixtures | 285, 286, 287 | Bubble Levels | 140 |
| Bathroom Fixtures - WaterMark | 285, 286, 287 | Bucket | 61 |
| Bathroom Module | 286 | | |
| Batteries | 78, 157, 158 | C Cabin Hooks | 212 |
| Battery Boxes | 158 | Caframo Fans | 195, 196 |
| Battery Isolator | 159 | Cafree Altitude Support Pole | 36 |
| Battery Monitors | 78, 156 | Camco Camping Essentials | 61 |
| Bayonet Dust Cap | 203 | Camco Chocks | 125 |
| Bayonet Socket | 203 | Camco Cleaning | 217 |
| Bearing Cones | 137, 138, 139 | Camco Curved Leveller | 126 |
| Bearing Seals | 137, 138, 139 | Camco Fridge Bars | 107 |
| Bearings | 137, 138, 139 | Camco Grab Handles | 119 |
| Bed Frames | 48 | Camco Rhinoflex | 297 |
| Bed Saddles | 51 | Camco Sewer Fittings | 297 - 300 |
| Bezel for Sink | 282 | Camco Sewer Hose | 297 - 300 |
| Bike Rack Ramp | 86 | Camco Toilet Tissue | 283 |
| Bike Racks | 86, 87, 118 | Camec Door Locks | 214 |
| BiPots | 288 | Camper Covers | 120 |
| Black Corner Steady | 144 | Camper Lifter | 50 |
| Black Nuova Mapa Adjustable Table | 113 | Camper Stone Shields | 150 |
| Black Shale Fade - Awning | 41 | Camper Trailer Storage | 119 |
| Black Streak Remover | 217 | Camping Essentials | 60 - 64 |
| Black Sunscreen | 33 - 35 | Canopy Easy Lift Arms | 49 |
| Black TV Brackets | 317, 318 | Canopy Lift Mechanisms | 49 |
| Blinds | 149 | Car Audio | 326 |
| Bluetooth Speakers | 322, 329 | Caravan Bed Frames | 48 |
| Boaties Cookware | 106 | Caravan Ceramic Coating | 218, 219 |
| Boomerang | 66 | Caravan Covers | 120 |
| Bora Fan | 196 | Caravan De-Flapper Kits | 24 |
| Bostik Compounds | 220 | Caravan Loo Treatment | 301 |
| Brackets for Awning Legs | 22 | Caravan Power Adapters | 182, 183 |
| Brackets for Pole Carriers | 109 | Caravan Reversing Cameras | 313 - 316 |
| Brackets For TVs | 317, 318 | Caravan Stone Shield | 150 |
| Brake Controllers | 77, 78, 79 | Caravan Supply Leads | 187, 188 |
| Brake Magnet | 136 | Caravan Touch Up Paint | 219 |
| Brake Shoe Kit | 137 | Caravanstore Awnings | 14 |
| Brass Fittings | 201, 202, 203 | Caravanstore Centre Rafter | 20 |
| Break Away Coil | 78 | Carbon Monoxide Alarm | 156 |

| | | | |
|----------------------------------|--------------------|------------------------------|--------------------|
| Carefree Altitude Awnings | 36, 37 | Coast Jockey Wheels | 128 |
| Carefree Awning Hardware | 36, 39, 42 | Coast Leads | 179 |
| Carefree Awning Maintenance Tips | 45 | Coast Lights | 160, 161, 162 |
| Carefree Awning Spares | 44 | Coast Matting | 28, 29 |
| Carefree Awnings | 36 - 46 | Coast Picnic Tables | 114 - 116 |
| Carefree Box Awning | 45 | Coast Pop Top Support | 50 |
| Carefree Curved Rafter | 38 | Coast Red Ramps | 127 |
| Carefree Rafters | 38, 42, 43 | Coast Roof Rafter | 26 |
| Carefree Straight Rafter | 38 | Coast Step | 132 |
| Cargo Bar | 71 | Coast Steps | 132, 133 |
| Carry Bike Accessories | 89, 90 | Coast Sunscreens | 33 - 35 |
| Carry Bikes | 87 - 90 | Coast Tables | 114 - 116 |
| Cassette Toilets | 294, 295 | Coast Tie Downs | 62 |
| Caulking | 221 | Coast Water Tanks | 270 |
| CD/DVD Players | 326 | Coax Cable Connection | 178 |
| Ceramic Coating | 218, 219 | Coaxial Sockets | 178 |
| Ceramic Sink | 284 | Coffee Cup | 66, 69 |
| Check Valves | 263 | Collapsible Bucket | 61 |
| Chocks | 125, 126, 127 | Collapsible Homeware | 65 |
| Chromed Faucets | 285, 286, 287 | Collapsible Storage | 65 |
| Circuit Breaker Leads | 180 | Coloured Cups | 67 - 69 |
| Circuit Breakers | 180 | Coloured Plates | 68, 69 |
| Cladding | 53 | Columbia Doors | 214 |
| Cleaners | 122, 123, 217, 218 | Combination Cookers | 245 - 249 |
| Cleaners for HWS Tanks | 337 | Compact Brake Controller | 77 |
| Cleaning Kit | 218 | Compact IQ Brake Controller | 77 |
| Cleaning Products | 122, 123, 217, 218 | Concentrated Toilet Drop Ins | 301, 302 |
| Clip On Mirrors | 74 | Cones for Bearings | 137, 138, 139 |
| Clip Systems | 22 | Control Boxes For Windows | 215, 216 |
| Clips | 71 | Controllers - Throttle | 99 |
| Clipsal Fittings | 177, 178 | Cookers | 245 - 253 |
| Clothes Airer | 106 | Coolmatic Fridges | 239, 240 |
| CMS Fittings | 180, 181 | Copper Pigtales | 199 |
| CO2 Alarm | 156 | Corner Insert For Windows | 216 |
| Coast Aluminium | 53 | Corner Steadies | 143, 144 |
| Coast Annex Awning | 12 | Couple-Mate Reversing Hitch | 140 |
| Coast Awning Wall Kits | 12 | Coupling Locks | 130, 132, 147, 148 |
| Coast Bearing Seals | 138, 139 | Couplings | 141, 143 |
| Coast Bike Racks | 86, 87, 118 | Covers - Carry Bikes | 90 |
| Coast Carriers | 109 | Covers - Circuit Breakers | 180 |
| Coast Clean Kit | 218 | Covers - RV | 120 |
| Coast Coupling Lock | 132 | Covers - Vents | 227 |
| Coast Doors | 208, 209, 210 | Crank Up Satellite Spares | 309 |
| Coast Fire Pits | 64 | Cross Bars | 117 |
| Coast Hand Pump | 286 | CRX Fridge Freezers | 239, 240 |

INDEX

| | |
|-------------------------|------------|
| Cupboard Rosettes | 213 |
| Cups | 66 - 69 |
| Curt Spectrum | 79 |
| Curt Towing Accessories | 79 - 82 |
| Curtain Track | 52 |
| Curved Centre Rafter | 20, 26, 38 |

| | |
|-------------------------------|-------------------------|
| D Data Storage | 315 |
| Decoder | 324 |
| Deep Cycle Batteries | 157 |
| Deodorisers For Toilets | 290, 291, 292, 301, 302 |
| DGN Hinges | 216 |
| Dicor Sealant | 219 |
| Diesel Fuel Tank | 7 |
| Diesel Heaters | 7, 8 |
| Digital Signal Finders | 312 |
| Dinnerware | 68, 69, 104, 105 |
| Directors Chair | 60 |
| Dish Drainer | 65, 106 |
| Dish Holder | 106 |
| DO35 | 141 |
| Dometic Air Conditioners | 4, 5, 6 |
| Dometic Dust Reduction System | 224 |
| Dometic Fridge Spare Parts | 241, 242 |
| Dometic Fridges | 240 |
| Dometic Heating System - Air | 7 |
| Dometic H-Frame | 4 |
| Dometic Rangeshoods | 234 |
| Door Catch | 213 |
| Door Frames | 212, 213, 214 |
| Door Holder | 118, 212 |
| Door Locks | 214 |
| Door Mosquito Nets | 108 |
| Door Roller | 26 |
| Door Storage Pockets | 120 |
| Doors For Suburban Heaters | 335 |
| Double Sided Sailtrack | 52 |
| Draught Skirt | 11 |
| Drifter Monitor | 156 |
| Drink Water Filtration Kit | 263, 266, 267 |
| Drink Water Freshener | 281 |
| Drink Water Hose | 267, 268 |
| Drinkware | 66 - 69 |
| Drone | 66 |
| Drum Brakes | 135, 136, 137 |

| | |
|------------------------|-----|
| DS- 5 Satellite Spares | 309 |
| DT- 8 Mark 3 Antenna | 312 |
| Duplex Oven | 247 |
| Dust Cap for Bayonets | 203 |
| Dustbin | 107 |

| | |
|---------------------------------|---------------|
| E Easy Dry | 106 |
| Easy-Tune Signal Finder | 312 |
| Eaz Lift Hitches | 93 - 96 |
| Eaz Lift Sway Controls | 95 |
| E-Bikes | 100 |
| Eclipse Awnings | 41, 42 |
| EcoSpin Portable Washer | 237 |
| Egg Carriers | 61 |
| Electrex Electrical Components | 188, 189 |
| Electric Bike | 100 |
| Electric Brake Magnet | 136 |
| Electric Drum Brakes | 135, 136, 137 |
| Electric Steps | 134 |
| Electrical Equipment | 156 - 197 |
| Electronic Brake Controllers | 77, 78, 79 |
| Electronic Throttle Controllers | 99 |
| Electus Anderson Plug | 178 |
| Electus RCD | 182 |
| Elixir Mini Vent | 222 |
| End Plug For Windows | 216 |
| Enduromats | 30 |
| Entry Way Matting | 29 |
| Etourer | 100 |
| Explore Levels | 126 |
| Extension Leads | 179 |
| Exterior Doors for Suburban | 335 |
| External Cookers | 251, 252 |
| External Showers | 284, 285 |

| | |
|------------------------------|-------------------------------|
| F F35 Pro Awnings | 14 |
| F45 Awnings | 15, 16 |
| F65 Replacement Awnings | 17, 18, 19 |
| F80 | 17, 18, 19 |
| Falcon Mirrors | 74 |
| Fan and Light Combo | 156 |
| Fans | 156, 190, 195, 196, 222 - 229 |
| Fantastic Endless Breeze Fan | 156 |
| Fantastic Vents | 224 |
| Faucets | 285, 286, 287 |

| | | | |
|---------------------------|---------------|-----------------------------|---------------------|
| Female Gas Floor Socket | 203 | Floor Matting | 28 - 30 |
| Festoon Globes | 165 | Foam Tape | 53 |
| Fiamma Accumulator Tank | 280 | Fold Away Antennae | 311 |
| Fiamma Adapter Brackets | 20, 21 | Folding Bike Rack | 85, 86 |
| Fiamma Awnings | 14 - 20 | Folding Ironing Board | 107 |
| Fiamma Carry Bikes | 87 - 90 | Folding Tables | 114 - 116 |
| Fiamma Door Holder | 118 | Four Seasons Hatch | 224 |
| Fiamma Draught Skirt | 11 | Frames For Beds | 48 |
| Fiamma Easy Dry | 106 | Freedom Awning | 45 |
| Fiamma F80 | 17, 18, 19 | Freeview Decoder | 309 |
| Fiamma Fast Clip | 22 | Freeview TVs By Telesat | 309 |
| Fiamma Ladders | 23 | Fresh Up Sets (Thetford) | 295 |
| Fiamma Levels | 125 | Fresh Water Pump | 261 - 263 |
| Fiamma Omni Stop | 108 | Fridge Airator | 107 |
| Fiamma Privacy Rooms | 9, 10 | Fridge Bars | 107 |
| Fiamma Rafters | 20 | Fridge Braces | 107 |
| Fiamma Rain Guards | 21 | Fridge Fans | 238 |
| Fiamma Rivets | 21 | Fridge Sunscreen | 35 |
| Fiamma Royal Blue | 15 - 20 | Fridge Switch | 238 |
| Fiamma Royal Grey | 14 - 20 | Fridge Vent Sunscreen | 35 |
| Fiamma Security Handles | 118 | Fridge/Freezers | 239 - 244, 254, 255 |
| Fiamma Side Walls | 11 | Fridges | 239 - 244, 254, 255 |
| Fiamma Soap Dispenser | 108 | Front Sunscreens | 33 - 35 |
| Fiamma Steps | 133 | Fuel Filler | 265 |
| Fiamma Storage Pockets | 120 | Fuel Storage | 7, 281 |
| Fiamma Table Leg Parts | 11 | Fuel Tanks | 7, 281 |
| Fiamma Toilet Tissue | 283 | Furrion | 313, 327, 328, 329 |
| Fiamma Toilets | 288 | Furrion Vision S Camera | 313 |
| Fiamma Vents | 224, 225, 226 | Fusion Audio Entertainment | 326 |
| Fiamma Waste Tank | 300 | | |
| Fiamma Water Fillers | 265 | G Galvanised H-Frame | 4 |
| Fiamma Water Tank | 270 | Galvanised Shackles | 72 |
| Fiamma Winding Handles | 21, 22 | Games | 66 |
| Fiesta Awnings | 39 - 41 | Gas Bottle Slide Kit | 203 |
| Filters | 263 | Gas Cradles | 203 |
| Filtration Kit | 263, 266, 267 | Gas Cylinder Strap | 203 |
| Fire Blanket | 110 | Gas Cylinders | 203 |
| Fire Extinguisher | 110 | Gas Detectors | 203 |
| Fire Extinguisher Holders | 110 | Gas Fittings | 201, 202, 203 |
| Fire Pit | 64 | Gas Floor Socket | 203 |
| First Aid | 110 | Gas Hose | 199, 200, 201 |
| Fix-A-Tap Hose | 267 | Gas Regulators | 198, 199 |
| Flat Out Hose | 267 | Gas Sealant | 198 |
| Flat Out Storage Reels | 108 | Gas Sealing Tape | 198 |
| Flick Mixers | 285, 286, 287 | Gas Struts | 47 |

INDEX

| | |
|------------------------------|-------------------------|
| Gas Testing Nipple | 203 |
| Gas Unions and Adapters | 201, 202, 203 |
| Gas Water Heaters | 331 - 334 |
| Gasket Kit - Air Conditioner | 4 |
| Generators | 197 |
| Globes | 165 |
| Glo-X | 62, 63 |
| Grab Handles | 118, 119, 160, 161 |
| Grass Mat | 29 |
| Grey Water Deodoriser | 290, 291, 292, 301, 302 |
| Guard - Tyre | 121 |
| Gullwing Hitch Lock | 148 |
| Guy Ropes | 62 |

| | |
|--------------------------------|------------------------|
| H Haigh Levels | 126 |
| Hand Brake Spares | 73 |
| Hand Pumps | 285, 286 |
| Happy Bowl Toilet Liners | 302 |
| Happy Hook Awning Tie | 24 |
| Happy Wanderer Antennae | 312 |
| Happy Wanderer Signal Booster | 312 |
| Harrier Air Conditioner | 6 |
| Hatch | 222 - 229 |
| Hayman Reese Brake Controllers | 77 |
| Hayman Reese Hitches | 91, 92 |
| HDMI Cable | 320 |
| HDMI Splitter | 321 |
| Heavy Duty Coupling Locks | 130, 132, 147, 148 |
| Heavy Duty Water Tanks | 270 |
| Heavy Duty Wheel Clamp | 141 |
| Hex Winder Handle | 130 |
| H-frames | 4 |
| Hinge | 216 |
| Hitch Locks | 71, 131, 132, 147, 148 |
| Hitch Step | 72 |
| Hold Down Strap Kit | 22, 24, 25, 62 |
| Holman Hose Adapter Set | 271 |
| Hooks for Cabins | 212 |
| Hose - Carriers | 109 |
| Hose - Gas | 199, 200, 201 |
| Hose - Lido Junior | 251 |
| Hose - Sewer | 297 - 300 |
| Hose - Shower | 284 - 286 |
| Hose - Water | 267, 268 |
| Hose Adapters | 271 |

| | |
|---------------------------|---------------|
| Hose Connector Set | 271 |
| Hose Storage | 109 |
| Hot Water Service Flusher | 337 |
| Hot Water Services | 331 - 334 |
| Hub Drums | 135, 136, 137 |
| Hush Smoke Alarm | 156 |
| HWS Tank Rinser | 337 |
| Hydrosilex | 218, 219 |

| | |
|-------------------------------|---------------|
| I Ibis Air Conditioner | 4 |
| In-Line Check Valves | 263 |
| Interconnecting Leads | 180 |
| Interior Ladders | 23 |
| Interior Lights | 162, 166, 167 |
| Interior Speakers | 326, 327, 328 |
| Inverter Generators | 197 |
| Ironing Board | 107 |

| | |
|-------------------------------|-----------|
| J Jack Pads | 124 |
| Jack Stands | 124, 125 |
| Jacks | 124, 125 |
| Japanese Bearings NSK | 139 |
| Jayco Bag Awning Poles | 28 |
| Jayco Fan Light | 156 |
| Jensen Spare Parts | 223 |
| Jerry Can Holders | 135 |
| Jockey Wheel Clamps | 129, 130 |
| Jockey Wheel Receiver | 125 |
| Jockey Wheels | 128 - 131 |
| John Guest Plumbing | 271 - 277 |
| John Guest Tempering Valve | 287 |
| John Guest WaterMark Fittings | 274, 275 |
| Jug | 70 |

| | |
|--------------------|----------|
| K Kids Toys | 66 |
| Kitchen Broom | 107 |
| Kitchen Sinks | 281, 282 |
| Kojack Jack Kit | 146 |
| Kombi Hatch | 225 |
| Kovix | 131 |

| | |
|------------------------|---------------|
| L Ladders | 23 |
| Lantern Hanger | 61 |
| Lap Sealant | 219 |
| Laundry Accessories | 106, 235, 237 |
| LCC27 Class Connectors | 201 |

| | |
|------------------------|--|
| LCI Lippert Brakes | 135, 136 |
| LCI Sway Command | 84 |
| LED Picnic Table | 115 |
| LED TVs | 319 |
| LEDs | 160 - 167 |
| LEDs | 166, 167 |
| Lenses for Lights | 160 |
| Levelling Systems | 125, 126, 127 |
| Lido Junior Cookers | 251 |
| Lift Mechanisms | 49 |
| Lift-O-Mat Struts | 47 |
| Lighting Tracks | 25 |
| Lights | 156, 160, 161, 162, 164 - 167, 169 - 170 |
| Link Box For Windows | 215, 216 |
| Lipper Slide Outs | 54, 55 |
| Lippert Brakes | 135, 136 |
| Lithium Batteries | 157 |
| Load Indicator | 145 |
| Lockable Water Fillers | 265, 266 |
| Loo Treatment | 301 |
| Loxeal Sealant | 198 |
| Lubricant | 292 |
| Luggage Rack | 117 |
| <hr/> | |
| M Maestro | 196 |
| Male Bayonet Socket | 203 |
| Manchester Tanks | 203 |
| Marine Speakers | 326, 329 |
| Matting | 28 - 30 |
| Max De-Flapper Kits | 24 |
| MaxxAir Ventilation | 226, 227 |
| Melamine Dinnerware | 104, 105 |
| Mesh - Stone Shield | 151 |
| Metal Grab Handles | 211 |
| Microwave Oven | 253 |
| Microwave Turntable | 253 |
| Mid Mount E-Bike | 100 |
| Mildew Remover | 217 |
| Milenco Aero | 74 |
| Milenco Doors | 214 |
| Milenco Mirrors | 74 |
| Milenco Security Pin | 131 |
| Milenco Wedges | 149 |
| Millard Water Tank | 269 |
| Mini AmpFibian | 182 |

| | |
|-----------------------------|------------|
| Mini Dish Drainer | 106 |
| Mini First Aid Kit | 110 |
| Mini Vent | 222 |
| Minigrill HOBs | 249 |
| Mirrors | 74, 75, 76 |
| Mobile Wifi Router | 325 |
| Modular Water Tank | 270, 271 |
| Mold Inserts | 51, 52 |
| Mosquito Nets | 108 |
| Motorhome Covers | 120 |
| Motorhome Reversing Cameras | 313 - 316 |
| Mount for Tablet | 330 |
| Mounting Blocks | 180 |
| MPPT | 186 |
| Mud Flaps - Stone Shield | 151 |
| Muller PVC Vent | 229 |
| Multi Purpose Floor Matting | 28 - 30 |
| Multi Switch | 321 |
| My Coolman | 254, 255 |

N

| | |
|----------------------------|-----------|
| Narva Electrical Fittings | 171 - 175 |
| Narva Heavy Duty Connector | 187, 188 |
| Narva Lights | 163, 164 |
| Narva Plugs and Sockets | 184 |
| Nemesis Wheel Clamp | 147 |
| Neta Hose Adapter | 271 |
| Nextech Transceiver | 318 |
| No Nails Adhesive | 220 |
| Non-Slip Matting | 28 - 30 |
| NSK Japanese Bearings | 139 |
| Nuova Mapa Steps | 134 |
| Nuova Mapa Table Leg | 113 |
| Nuts | 133 |
| Nylon Bushes | 144 |

O

| | |
|---------------------------|-----------|
| Odour-B-Gone Toilet Disks | 301 |
| Off Road Couplings | 141 |
| Off Road Hitch Lock | 148 |
| Offside Privacy Screen | 35 |
| On Demand Water Heater | 338 - 340 |
| Orbit Air | 13 |
| Outlets For Waste | 283 |
| Ovens | 245 - 249 |

P

| | |
|---------------------|---------|
| Palm | 66 - 69 |
| Panorama Door Locks | 214 |

INDEX

| | | | |
|--------------------------------|--------------------|--------------------------------|------------|
| Pedal Box Throttle Controllers | 99 | Privacy Rooms | 9, 10 |
| Picnic Tables | 114 - 116 | Privacy Sunscreens | 33 - 35 |
| Pigtails | 199 | Prodigy Brake Controller | 77 |
| Pipeline Plumbing Fittings | 279 | Protection Pad | 71 |
| Plas-T-Cote | 219 | Protector Shade Stays | 216 |
| Plastic Bag Storage | 107 | PurpleLine | 146 - 148 |
| Plastic Bed Saddles | 51 | Push Button Catch | 213 |
| Plastic Fuel Cans | 280 | Push Rod | 51 |
| Plastic Glasses | 66 - 69 | PVC Vent | 229 |
| Plastic Grab Handles | 118, 119, 160, 161 | PWM | 186 |
| Plastic Plumbing Fittings | 271 - 279 | | |
| Plastic Steps | 133 | Q Qube Porta Pottis | 289 |
| Plate Storage | 106 | Quell Carbon Monoxide Alarm | 156 |
| Plugs | 175 - 182 | Quick Fit Bike Racks | 85, 86 |
| Plugs - Sinks | 283 | | |
| Plumbers Silicone | 219, 220 | R Radio Antenna | 317 |
| Plumbing Fittings | 271 - 279 | Radios | 326, 328 |
| Plumbing Fittings - WaterMark | 274, 275 | Rain Guards | 21 |
| POD Adapter | 183 | Ratchet Straps | 203 |
| Pole Carriers | 109 | Recreational Games | 66 |
| Polysafe Drinkware | 66 | Reflectors | 168 |
| Pop Top Covers | 120 | Regulators - Gas | 198, 199 |
| Pop Top De-Flapper Kits | 24 | Regulators - Solar | 186 |
| Pop Top Insert Bow | 49 | Regulators - Water Pressure | 263 |
| Pop Top Roof Clamps | 50 | Reich Mirrors | 76 |
| Pop Top Supports | 50 | Remote control car | 66 |
| Pop-A-Bag Holder | 107 | Repair Tape | 25 |
| Porch Lights | 160, 161, 162 | Replacement Awning Poles | 28 |
| Porta Pottis | 289 | Replacement Globes | 165 |
| Portable Fridges | 254, 255 | Replacement Vent Lids | 222 - 226 |
| Portable Hard Drive | 324 | Reverse Cycle Air Conditioners | 4, 5, 6 |
| Portable RCD | 182 | Reversing Aids | 140 |
| Portable Speakers | 329 | Reversing Cameras | 313 - 316 |
| Portable Washers | 237 | Rhinoflex - Camco | 299 |
| Portable Waste Tank | 295, 300 | Rivets | 21 |
| Pots and Pans | 106 | ROKK Tablet Mount | 330 |
| Power Adapters | 182, 183 | Roll Out Awnings | 39 - 41 |
| Power Cord Storage | 109 | Rollo Vent 40 | 226 |
| Power Generators | 197 | Roof Cladding | 53 |
| Power Inlets | 175 - 177 | Roof Clamps | 50 |
| Power Inverter | 197 | Roof Racks | 117 |
| Power Outlets | 175 - 177 | Roof Rafters | 20, 26, 38 |
| Power Points | 175 - 182 | Roof Sealant | 219 |
| Powerless Light | 62, 63 | Roof Storage | 117, 118 |
| Premier One Cleaning | 122, 123 | Rosettes | 213 |

| | | | |
|--------------------------------------|-------------------------|--------------------------------------|-----------|
| Rotary Vent | 229 | Shurflo Filtration Kit | 263 |
| Rubber Bezel | 283 | Shurflo Pumps | 260, 261 |
| Rubber Radio Antenna | 317 | Shurflo Regulators | 263 |
| Rubbish Bin | 107 | Shurflo Spare Parts | 261, 263 |
| RV Electronics Fridge Switch | 238 | Side Cladding | 53 |
| RV Plus Power Adapter | 183 | Side Sunscreens | 33 - 35 |
| RV-02 Max Power Adapter | 183 | Side Wall for Fiamma Awnings | 11 |
| <hr/> | | | |
| S Sachets - Thetford Aqua Kem | 291 | Signal Finders | 307, 312 |
| Safe Towing Tips | 97, 98 | Silicone Sealants | 219, 220 |
| Sailtrack | 52 | Simson ISR | 221 |
| Salad Bowl | 70 | Single Sided Sailtrack | 52 |
| Saracen Hitch Locks | 147, 148 | Sink Plugs | 283 |
| Satellite Decoder | 324 | Sinks | 282, 283 |
| Satellites | 323 | Sirocco Fan | 195 |
| Satking Satellite Box | 324 | Sizzler Accessories | 252 |
| Screw-On Level | 140 | Sizzler Barbeque | 252 |
| Scupper Vent | 229 | Slide Kit - Gas Bottle | 203 |
| SD Card | 315 | Slide Kits - Barbeque | 252 |
| Seal Spray | 292 | Slide Lock for Windows | 216 |
| Sealant | 219, 220 | Slide Out Rooms | 54, 55 |
| Sealing Tape | 53 | Slotted Winder Handle | 130 |
| Seals for Bearings | 137, 138, 139 | Smart TV | 319 |
| Security Cable | 132 | Smev Sink Parts | 282 |
| Security Handles | 118, 119 | Smoke Alarm | 156 |
| Sensar HV Antenna | 306, 307 | Soap Dispenser | 108 |
| Sensar RVH 3095 Antenna | 307 | Sockets | 184 |
| Sensor Pro | 307 | Solar Fridge Fan | 238 |
| Service Doors | 208, 209, 210, 212, 213 | Solar Panels | 185 |
| Setec Drifter | 156 | Solar Regulators | 186 |
| Sewer Fittings | 297 - 300 | Spanner Tube- Suburban | 337 |
| Sewer Hose | 297 - 300 | Spanners | 140 |
| Sewer Hose Connections | 297 - 300 | Spare Awning Poles | 28 |
| Shackle Spares | 142 | Spare Parts - Carefree | 44 |
| Shackles | 142 | Spare Parts - Dometic Fridges | 241, 242 |
| Shade Stays | 216 | Spare Parts - Eaz Lift | 96 |
| Shanks - Eaz Lift | 94 | Spare Parts - Fiamma Bi-Pots | 288 |
| Shanks - Hayman Reese | 92 | Spare Parts - Fiamma Vents | 226 |
| Shower Hoses | 284 - 286 | Spare Parts - Fiamma Waste Tank | 300 |
| Shower Kits | 284 - 286 | Spare Parts - Freedom Awning | 46 |
| Shower Mixers | 284 - 286 | Spare Parts - Hand Brake | 142 |
| Showers | 284 - 286 | Spare Parts - Mirrors | 75 |
| Shurflo Accumulator Tank | 280 | Spare Parts - Prodigy | 78 |
| Shurflo Barbs | 262 | Spare Parts - Reversing Cameras | 314 |
| Shurflo Filters | 263 | Spare Parts - Shurflo Filtration Kit | 261 |
| | | Spare Parts - Shurflo Pumps | 262 - 263 |

INDEX

| | | | |
|---------------------------------------|-------------------------|---------------------------------|---------------|
| Spare Parts - Sphere Microwave | 253 | Storage for Batteries | 158 |
| Spare Parts - Sphere Washing Machine | 236 | Storage for Kitchenware | 106 |
| Spare Parts - Stone Shields | 151 | Storage for Water | 269, 270, 271 |
| Spare Parts - Suburban | 331 - 334 | Straight Centre Rafter | 21 |
| Spare Parts - Thetford Cookers | 250 | Strap Ratchet | 203 |
| Spare Parts - Thetford Fridges | 244, 245 | Striker Plate | 213 |
| Spare Parts - Thetford Toilets | 296, 297 | Strip Caulking | 221 |
| Spare Parts - Vents | 222 - 226 | Suburban Anode Rod | 335 |
| Spare Parts - Winegard | 308 - 311 | Suburban Exterior Doors | 335 |
| Spare Parts - Winegard Satellite | 309, 310 | Suburban Spare Parts | 331 - 334 |
| Spare Parts Carefree Altitude Awnings | 37 | Suburban Water Heater Tips | 336 |
| Spares - Outlet Flaps | 177 | Suburban Water Heaters | 331 - 334 |
| Spares - Shackles | 142 | Sunscreen | 33 - 35 |
| Spats | 135 | Sunscreen - Offside | 35 |
| Speakers | 322, 326, 327, 328, 329 | Surburban Nautilus | 338 - 340 |
| Sphere Battery | 157 | Surburban Nautilus Access Doors | 339 |
| Sphere Cables | 320 | Surburban Nautilus Vents | 339 |
| Sphere Ekon TV Arm | 318 | Surface Mount Accessory Sockets | 184 |
| Sphere Lighting System | 169, 170 | Surge Protector | 183 |
| Sphere Lithium Batteries | 157 | SW4DERA Suburban Heater | 334 |
| Sphere Microwave | 253 | SW5EA Suburban Heater | 333 |
| Sphere Rangehoods | 234 | SW6DERA Suburban Heater | 332 |
| Sphere Reversing Cameras | 313, 314 | SW6DRA Suburban Heater | 331 |
| Sphere S8 TVs | 319 | Sway Command Kit | 84 |
| Sphere Satellite | 323 | Sway Controls | 95 |
| Sphere Smart TV | 319 | Switch - Fridge | 238 |
| Sphere Solar Regulators | 186 | Switch Plates | 181 |
| Sphere TV Brackets | 317, 318 | | |
| Sphere TV Fittings | 321 | T Table Hinge Kit | 116 |
| Sphere Twin Cell Solar | 185 | Table Legs | 111 - 113 |
| Sphere Washing Machines | 235, 236, 237 | Table Tennis | 66 |
| Sphere Wifi Router | 325 | Tables | 111 - 113 |
| Spigot Bracket | 26 | Tablet Mount | 330 |
| Splitter | 321 | Tailgate Protection | 71 |
| Spring Bushes | 144 | Tank Freshener | 292 |
| Square Water Fillers | 266 | Tank Monitors | 156 |
| Stabiliser - Awning | 22, 24, 25, 62 | Tanks - Water | 269, 270, 271 |
| Stabiliser Jacks | 125 | Tap Mixers | 285, 286, 287 |
| Stabilus Gas Struts | 47 | Tape Foam | 53 |
| Stack-A-Plate | 106 | Tarp Clips | 71 |
| Stainless Steel Sinks | 282, 283 | Taste Pure Water Freshener | 281 |
| Stakka Jacks | 124 | T-Bar Antenna | 312 |
| Step Covers | 133 | Telesat TVs | 309 |
| Steps | 132, 133, 134 | Tempering Valves | 287 |
| Stone Shields | 150 | Testing Nipple | 203 |

| | | | |
|----------------------------------|--------------------|--------------------------------|-----------|
| The POD | 183 | Treg Pin Lock | 140 |
| Thermal Blind | 149 | Trimatic Door Locks | 215 |
| Thetford Additives | 290 - 292 | Triple Black Shale Fade Awning | 41 |
| Thetford Cleaners | 290 - 292 | Triplex Ovens | 245 - 249 |
| Thetford Cookers | 245 - 250 | Tripod | 315 |
| Thetford Fridge Spare Parts | 244, 245 | Trojan Hand Pumps | 285 |
| Thetford Fridges | 243, 244 | Truline Aluminium | 51 |
| Thetford Service Doors | 213, 214 | Truma Air Heater | 7 |
| Thetford Sinks | 282 | Truma Aventa Air Conditioner | 5, 6 |
| Thetford Toilet Accessories | 290 - 292 | Tube Spanner - Suburban | 337 |
| Thetford Toilet Tissue | 293 | Turbo 28 Vent | 225 |
| Thetford Toilets | 289, 294, 295 | Turbo Vent 160 | 225 |
| Thirsty Nomad Filter | 267 | TV Antennae | 306 - 312 |
| Thread Sealant | 198 | TV Brackets | 317, 318 |
| Throttle Controllers | 99 | TV Cables | 320 |
| Thru-Van-Wall Connection | 312 | TV Fittings Sphere | 321 |
| Tidy Turf Mat | 29 | TV Signal Boosters | 307, 312 |
| Tiedowns | 22, 24, 25, 62 | TV Signal Finders | 307, 312 |
| Tips - Carefree Awnings | 45 | TV Slide | 322 |
| Tips - Safe Towing | 97, 98 | TVs | 319 |
| Tips - Suburban Water Heaters | 336 | Twin Cell Solar | 185 |
| Toilet Bowl Cleaner | 291 | Twin Jockey Wheels | 130 |
| Toilet Bowl Liners | 302 | TwinTrack | 25 |
| Toilet Tissue | 293 | Two-In-One Tool | 337 |
| Toilets | 288, 289, 294, 295 | Tyre Guard | 121 |
| Touch Up Paint | 219 | Tyre Inflators | 186, 187 |
| Tow Ball Mount | 70 | Tyre Pressure Monitor | 83 |
| Tow Ball Scales | 145 | | |
| Tow Ball Spanner | 140 | U UHF 2W | 318 |
| Tow Balls | 70 | Unimaxx Vent Lid | 223 |
| Tow Load Indicator | 145 | Universal Vent Lid | 223 |
| Tow Secure Break Away Kit | 78 | USB | 177, 182 |
| Towing Mirrors | 74, 75, 76 | USB Socket | 177, 182 |
| Towsafe Weight Scales | 145 | | |
| Toylok | 119 | V Valteera Access Hatch | 215 |
| Toys | 66 | Valterra Hose Mender | 263 |
| TPMS | 83 | Valterra Sewer Hose | 297 |
| Trail-A-Mate | 123, 124 | Valterra Sewer Valves | 297, 298 |
| Trail-A-Mate Lock | 124 | VarioHeat | 7 |
| Trailer Cop Coupling Lock | 131 | Vast Box | 324 |
| Trailer Plugs | 187, 188 | Vent 28 | 225 |
| Trailers Bearings - NSK Japanese | 139 | Ventline Spare Parts | 223 |
| Trash Can | 107 | Ventline Vents | 223 |
| Travelite Sunscreen | 31, 32 | Vents | 222 - 229 |
| Tread Grips | 149 | Video Storage | 324 |
| | | Vinyl Repair Glue | 25 |

INDEX

| | |
|--------------------------|-----|
| Vision S Furrion Camera | 313 |
| VLP Vinyl Repair | 25 |
| Voyager Brake Controller | 77 |

W

| | |
|--------------------------------|--------------------|
| Waeco Fridge Accessories | 238 |
| Waeco Fridges | 239, 240 |
| Walkie Talkie | 318 |
| Wall Kits | 12 |
| Wall Mount Trash Can | 107 |
| Wash and Wax | 217 |
| Washing Machines | 235, 236, 237 |
| Waste Hose | 267, 268 |
| Waste Kit for Plugs | 283 |
| Waste Outlets | 283 |
| Waste Tanks | 295, 300 |
| Water Fillers | 265, 266 |
| Water Freshener | 281 |
| Water Heaters | 331 - 334 |
| Water Purifyer | 267 |
| Water Tablets | 281 |
| Water Tank - Modular | 270, 271 |
| Water Tank Anode Rod | 335 |
| Water Tank Monitors | 156 |
| Water Tanks | 269, 270, 271 |
| Water Tempering Valve | 287 |
| WaterMark | 274, 275, 286, 287 |
| Waterproof Lock | 131 |
| Weight Distribution Hitches | 93 - 96 |
| Wheel Chocks | 125, 126, 127 |
| Wheel Nut | 133 |
| Wheel Spats | 135 |
| Wheels for Jockey Wheels | 129 |
| Wifi Router | 325 |
| Wind Deflector | 148 |
| Winder Handles | 21, 22, 130 |
| Winding Handles - Awning | 21, 22 |
| Window Awnings | 38 |
| Window Parts | 216 |
| Winegard Satellite Spare Parts | 309, 310 |
| Winegard Satellite Spares | 308 |
| Winegard Sensor Antennae | 306, 307 |
| Winegard Sensor Pro | 307 |
| Winegard Spare Parts | 308 - 311 |
| Winegard Wingman Booster | 307 |
| Wineglass Table Leg | 112 |

| | |
|--------------------------|----------|
| Wingman Signal Booster | 307 |
| Wireless Lighting System | 169, 170 |
| Wiring Loom Assemblies | 134, 180 |
| WOW Control Boxes | 215 |
| WOW Slide Lock | 215 |
| WOW Winder Handle | 216 |

X

| | |
|-----------------------|--------|
| XF Folding Bike Racks | 85, 86 |
|-----------------------|--------|

Z

| | |
|--------------------------|-----|
| Z-Bond No Nails | 220 |
| Z-Bond Plumbers Silicone | 220 |

Lined area for notes, consisting of numerous horizontal lines.

SPHERE S8 SERIES LED TVS

androidtv

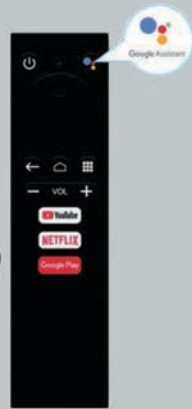

See More on Page 317

Built for Australian conditions and travel, the new Sphere S8 range features a Vibration Smart design

BUILT FOR TRAVELLING



STEEL CHASSIS



TV DVD COMBO



TIDY TURF MATS



See More on Page 29

All Tidy Turf Mats are made in Australia from high-quality UV resistant materials, and come in any size or shape needed to compliment your caravan or campsite.



Your Caravan Store with MORE !!

AUSTRALIA

coastrv.com.au

NSW (HEAD OFFICE) - (Trade Clients Only)

Building 1A/246 Miller Road, Villawood NSW 2163

Phone › 02 9645 7600

Fax › 02 9645 7688

Email › salesnsw@coastrv.com.au

VICTORIA OFFICE (Trade Clients Only)

Building 3A, 415 Cooper St, Epping VIC 3076

Phone › 03 9930 0500

Fax › 03 9930 0599

Email › salesvic@coastrv.com.au

QUEENSLAND OFFICE

48 - 56 Meakin Road, Meadowbrook QLD 4131

Phone › 07 3386 7100

Fax › 07 3386 7199

Email › salesqld@coastrv.com.au

WA OFFICE (Trade Clients Only)

Cnr Baile Rd & Barrel Way, Canning Vale WA 6155

(1 Barrel Way, Canning Vale WA 6155)

Phone › 08 9484 6000

Fax › 08 9484 6088

Email › saleswa@coastrv.com.au

NEW ZEALAND

coastrv.co.nz

NZ OFFICE (Trade Clients Only)

74 Greenmount Drive, East Tamaki Auckland

Phone › +64 9 274 8700

Email › enquiry@coastrv.co.nz

Technical Email ›

technical@coastrv.com.au Warranty Email ›

warranty@coastrv.com.au



Coast to Coast
CARAVAN & LEISURE